

RASHTRAPATI BHAVAN LIBRARY



Reg. No. 13223

Clas. No. III C1-B



Aide-de-Camp's Library

A HANDBOOK OF
RENAISSANCE ARCHITECTURE IN
ENGLAND, 1500-1800

A HISTORY OF RENAISSANCE ARCHITECTURE IN ENGLAND (A.D. 1500-1800).

By SIR REGINALD BLOMFIELD, R.A., Litt.D., F.S.A. 2 vols. Illustrated. 50s. net.

A HISTORY OF FRENCH ARCHITECTURE. By the same Author. 4 vols. Illustrated. £6 6s. net. Also sold separately: Vols. I and II (from the Reign of Charles VIII to the Death of Mazarin), 50s. net; Vols. III and IV (1661-1774), £4 4s. net.

A SHORT HISTORY OF RENAISSANCE ARCHITECTURE IN ENGLAND. By the same Author. Illustrated. 8s. 6d. net.

A TEXT-BOOK OF GOTHIC ARCHITECTURE. By G. H. WEST, D.D. Illustrated. 6s. net.

HELLENIC ARCHITECTURE. By EDWARD BELL, M.A., F.S.A. Illustrated. 7s. 6d. net; paper covers, 6s. net.

THE ARCHITECTURE OF ANCIENT EGYPT. By the same Author. Illustrated. 7s. 6d. net.

LONDON: G. BELL AND SONS, LTD.

A SHORT HISTORY OF
RENAISSANCE ARCHITECTURE
IN ENGLAND

1500-1800

BY SIR REGINALD BLOMFIELD,
R.A., LITT.D., F.S.A.
EXETER COLLEGE, OXFORD,
ARCHITECT

*With Drawings by the Author
and other Illustrations*

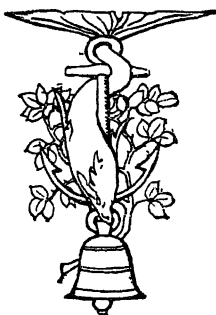

LONDON
G. BELL AND SONS, LTD.

1923

First published December 1900.

Reprinted 1904, 1907, 1910, 1914, 1923.

PRINTED IN GREAT BRITAIN.

CHISWICK PRESS: CHARLES WHITTINGHAM AND GRIGGS (PRINTERS), LTD.
TOOKS COURT, CHANCERY LANE, LONDON.

PREFACE

IN preparing this abridgment of my larger history I have endeavoured to supply the architectural student with a concise account of Renaissance architecture in England from 1500 to 1800. Extensive knowledge of detail is, in my opinion, of less importance to the student than a clear grasp of the historical development of this movement. When he has mastered its general drift and the actual causes which determined its modifications, his own observation will supply examples, which will fall naturally into their historical place. I have accordingly retained only such instances as appear to me to have an immediate bearing on the subject; and for fuller information as to facts and authorities and for some account of the architectural literature of the period, I must refer the student to my larger history. I have added plates of Palladio's orders, taken from Fréart's "Parallel," on account of their great technical importance in the architecture of the seventeenth and eighteenth centuries.

In order to avoid that overloading of detail which seems to me a dangerous snare in the student's path, I have not dealt with controversial points. The conclusions here set out are the results of my personal investigations. It is fair, however, to point out, that in one or two instances the conclusions at which I have arrived differ from those of other writers of authority on the subject. Mr. Gotch, in a paper contributed to the "Architectural Review" in February, 1899, maintains his view that the Thorpe collection of drawings is, with a few exceptions, the work of one man, and that that man was the

actual designer of the buildings shown. Mr. Gotch's criticism does not get over the fundamental difficulty, namely, the great divergence of treatment in the actually executed buildings which he claims for Thorpe. I have therefore adhered to my original conclusion. Again, in regard to the reintroduction of brickwork, Mr. John Bilson, of Hull, who has supplied me with some valuable information as to the brickwork of the eastern counties, is doubtful whether this reintroduction was due to the Flemings. For the reasons given in the text, I think myself that it was. Further investigation of contemporary evidence will no doubt settle the point. It does not, however, appear to me to be necessary that the younger student should concern himself with any such special problems of historical research.

For further illustrations of the period I may refer the student to Mr. Gotch's excellent series for the sixteenth and early seventeenth centuries, and to Messrs. Belcher and Macartney's series for the later seventeenth and eighteenth centuries.

REGINALD BLOMFIELD.

NEW COURT,
TEMPLE.

October 1900.

CONTENTS

CHAP.	PAGE
I. THE ITALIANS IN ENGLAND—HENRY VIII—EDWARD VI	3
II. THE GERMANS IN ENGLAND—ELIZABETH—JAMES I	19
III. THE ENGLISH BUILDERS	33
IV. SIXTEENTH CENTURY HOUSE PLANNING . . .	49
V. INIGO JONES	71
VI. JOHN WEBB, MARSH, AND GERBIER: THE LAST SURVIVALS OF GOTHIC	91
VII. SIR CHRISTOPHER WREN	109
VIII. WREN'S CONTEMPORARIES AND SUCCESSORS: JARMAN, WYNNE, BELL OF LYNN, TALMAN, VANBRUGH, HAWKSMOOR—ALDRICH, CLARKE, BURROUGH, ESSEX	143
IX. THE EIGHTEENTH CENTURY ARCHITECTS: ARCHER, JAMES, CAMPBELL, RIPLEY, LORD BURLINGTON, LEONI, KENT	164
X. GIBBS, WARE, FLITCROFT, VARDY, THE WOODS OF BATH, DANCE THE ELDER	179
XI. PAINE, MORRIS, TAYLOR, CARR OF YORK, CHAMBERS, GANDON, DANCE THE YOUNGER, ROBERT AND JAMES ADAM	195
XII. HOUSE PLANNING IN THE SEVENTEENTH AND EIGHTEENTH CENTURIES	216
XIII. THE TRADES: CARPENTRY, MASONRY	236
XIV. BRICKWORK, PLASTER WORK, LEAD, AND IRON	260
XV. CONCLUSION	293
INDEX	305

LIST OF ILLUSTRATIONS

SEPARATE PLATES.

	PAGE
The Palace of Audley End	36
Oriel College, Oxford	40
St. John's College, Cambridge	42
Ashdown House, Berks	96
St. John's Church, Leeds	98
Trinity College Chapel, Oxford	110
St. Paul's Cathedral from the West	122
St. Paul's Cathedral, Interior	124
Hampton Court	134
Houghton Hall, Norfolk	170
Moor Park, Hertfordshire	172
The Admiralty	174
Holkham House, Norfolk	176
The Horse Guards	178
King's College, Cambridge	182
Radcliffe Library, Oxford	184
Spencer House	188
Prior Park, Bath	190
The Mansion House, London	192
Kedleston Hall, Derby	196
Somerset House	204
The Custom House, Dublin	206
Clare College, Cambridge	258
Wotton House, Aylesbury	266
The Presence Chamber, Hardwick Hall, Derbyshire	272
The Ceiling of Bishop West's Chapel, Ely Cathedral	274
The Five Orders of Palladio and the Method of Setting out the Entasis to the Shaft of a Column	<i>at end</i>

ILLUSTRATIONS IN THE TEXT.

Garden Doorway, St. John's College, Oxford	<i>Frontispiece</i> 2
Terra-cotta Roundel, Hampton Court	5

	PAGE
Wolsey's Arms, Hampton Court, Terra-cotta	7
Chest on Choir Screen, Winchester	15
From the Salisbury Chantry, Christchurch, Hants	17
Door-head, Burgate Street, Canterbury	19
Doorway, Tenterden, Kent	23
Chimney-piece, Cobham, Kent	29
Gateway, Montacute House, Somerset	31
A Gable at Knowle	35
The Grange, Leominster	44
Carving, Butcher's Row, Hereford	45
School and Almshouse, Corsham	46
Gateway at Cobham College	47
Plan of Buckhurst House, Sussex	51
Plan of Audley End, Essex	53
Plan of Holland House	54
Plan of the Fishing-house at Meare	55
Unnamed plan in the Soane Collection	57
Garden House at Amesbury	58
Plan of Garden House at Amesbury	59
Plan of Thornton College, Sir Vincent Skynner's	60
Plan of Wymbledon	62
Plan of Wollaton Hall	64
Staircase, Wye College, Kent	65
Staircase, Hawkhurst, Kent	67
Staircase, formerly in Whitecross Street	68
Stairs, Christ's College, Cambridge	69
Drawing for door at Whitehall	73
Ground plan, Whitehall	76
The Banqueting Hall, Whitehall	79
Design for a church, probably St. Paul's, Covent Garden	81
Greenwich Hospital	83
Ceiling, Wilton, by Inigo Jones	85
Chimney-piece in the Double Cube Room, Wilton	87
Sketch for Chimney-piece, by Inigo Jones	89
Entrance Pier at Amesbury, by John Webb	92
Doorway at the Vyne, near Basingstoke, by John Webb	93
The Stables, Thorpe Hall	95
Design for a ceiling at Greenwich, by John Webb	97
The Chapel, Burford Priory, Oxfordshire	103
The Chapel, Lyte's-Cary, Somerset	105
The Chapel, Brasenose College, Oxford	107
Wren's plan for rebuilding London	113
Interior of St. Stephen's, Walbrook	115
St. Bride's Steeple, Fleet Street	117
St. Benet's, Upper Thames Street	119
Plan of St. Paul's, nearly as executed	125
St. Paul's, nearly as executed. A drawing by Wren	127
Chapel of Wolvesey Palace, Winchester	131
Hampton Court, north-east corner	133
Hampton Court, Detail of Gates	135

	PAGE
An elevation of Greenwich Hospital	137
Groombridge Place, Kent	139
Plan of Groombridge Place, Kent	140
Plan and elevation, Wren's drawings	141
Custom House, King's Lynn	145
A Doorway, King's Lynn	148
Plan of Blenheim	151
Elevation of Blenheim Palace	153
Christ Church, Spitalfields	156
Plan of Christ Church, Spitalfields.	157
All Saints', Oxford	161
St. Philip's, Birmingham	165
Elevation of Old Burlington House	169
St. Mary-Le-Strand	181
St. Leonard's, Shoreditch	193
Plan of Kedleston	197
Section of Wardour House, Wilts	199
Plan of Luton House	211
Section of the Library at Kenwood House	214
Staircase, Ashburnham House	217
Plan of Lindsey House	219
Plans of Eltham Club-House	221
Plan of Moor Park, Hertfordshire	225
Plan of Latham Hall	227
Plan and Elevation, Vol. I., No. 18, Wren's Drawings	229
Plans of Dr. Heberden's House in Pall Mall	231
Carving on panel, Christchurch, Hants	237
A Spur, Smarden, Kent	240
Weatherboarded house, Sissinghurst, Kent	243
Sparrow's House, Ipswich	245
Doorway at Burwash, Sussex	247
Walling at Amesbury, Wilts	249
Gatehouse, Sandwich	251
Stone Doorhead, Corsham	253
Abingdon Town Hall	255
St. George's, Great Yarmouth	257
Great Snoring Rectory, Norfolk	261
Choristers' School, Salisbury	269
House at Arundel	270
Stockton, Wilts.	271
Ceiling, Star Inn, Great Yarmouth	275
Cornice and Doorhead, Ashburnham House	277
Design for ceiling for His Majesty's drawing-room at Chiswick	278
Panel, Burwash, Sussex	279
Spandrel, Radcliffe Library, Oxford	281
Lead Cistern at the Vyne, Basingstoke	283
Rain-water head, St. John's College, Cambridge	285
Rain-water head, Shrewsbury	286
Lead Urn, Parham	287
Iron Standard, Burford Church	288

	PAGE
Casement fastener, Guildford	289
Detail of Gates, All Souls' College, Oxford	290
Part of Gate, North Chancel Aisle, Beverley Minster	291
Garden Door, Shaw House, Newbury	295
Stone Urn on Gate Pier, Hampstead Marshall	304

T

T

B



GARDEN DOORWAY, ST. JOHN'S COLLEGE, OXFORD.

A HANDBOOK OF RENAISSANCE ARCHITECTURE IN ENGLAND

1500-1800

CHAPTER I

THE ITALIANS IN ENGLAND—HENRY VIII-EDWARD VI

BY Renaissance Architecture in England, as treated of in this handbook, is to be understood that fresh departure in architecture which began with the tentative efforts of imported workmen in the reign of Henry VIII., which reached its highest degree of attainment in the hands of Inigo Jones and Wren, and eventually ran itself out in the uncertainties induced by the literary eclecticism of the end of the eighteenth century. The two factors to be considered in tracing the development of this movement are, on the one hand, the constant importation of foreign ideas, and, on the other, the tenacious tradition of a people with a great historic past in architecture. For various reasons the Renaissance was slow to gain a permanent footing in England, and from first to last the process of fusion and adjustment between these two elements occupied rather over a hundred years, and it was the work of the greatest architect this country has possessed to gather up the broken threads and weave them together into one splendid and harmonious architecture.

Broadly speaking, there are three main divisions, three groups of facts to be considered in dealing with the development of architecture in England since the days of the Renaissance: (1) the various isolated attempts of foreign workmen, in nearly

every case Italians, to introduce their own methods of workmanship; (2) the efforts of half-instructed native builders, and of Flemish and German workmen; (3) the mature Palladianism introduced by Inigo Jones, a method so modified and adapted by his genius as to be the foundation of all subsequent architecture in England for the next two hundred years. These three types are so distinct that there is, as a rule, little difficulty in distinguishing instances. The third type is so clearly marked off from its predecessors, and so much more permanent in its results, that the first two can only be regarded as byways of history, interesting indeed, and pathetic as the efforts of men groping in the dark, but off the main track of the Renaissance movement, and least of all to be taken as typical models of its methods. Besides, and outside these three groups, there are buildings which there is no reason to identify with Renaissance rather than with Gothic architecture, buildings which fairly represent the continuous building tradition of the country, such as Lake House, near Salisbury, and on a smaller scale cottages in every part of the country, and ranging down to the beginning of the present century. It is necessary to bear this fourth group constantly in mind, in so far as it was permanently present in the background of the English designer's mind, and led to innumerable modifications which differentiate the English Renaissance from parallel developments in other countries of Europe.

The first memorable introduction of foreign workmen into England was due to Henry VIII. and Wolsey. By an indenture dated January 11th, 1515, Wolsey leased Hampton Court for ninety-nine years, and he at once set to work to transform it into a palace of unexampled magnificence. His architect is unknown. It is probable that, as was the common custom, the general design was directed by Wolsey himself, and the work was carried out by workmen who contracted for each trade, and designed and executed their own details. Wolsey's work, probably the west front and the outer court, was more or less completed by 1520. The fabric was built by Englishmen, but Italians were employed for some, at least, of the ornament. The terra-cotta busts of emperors over the entrance are now known to have been made by Giovanni de Majano, to whom we shall return later. While the Italian influence lasted in England, terra-cotta busts and figures seem to have been in demand for the outside of buildings, the niches and hollow circles which are now empty

having probably been designed to receive these decorations. There is a complete example of a bust surrounded by a double wreath of foliage at St. Donat's Castle in Glamorganshire; but the most perfect instance is undoubtedly the terra-cotta plaque of Wolsey's arms supported by two amorini under a cardinal's



TERRA-COTTA ROUNDEL, HAMPTON COURT.

hat, which is set on the wall above the gateway of the clock tower at Hampton Court. This is dated 1525. Another famous example of the use of terra-cotta for large figure work in England is the tomb of John Young, Master of the Rolls, in the Rolls Chapel. This was executed by Torrigiano in 1516, and consists of a recumbent figure on a sarcophagus under an arch, with a figure of Christ and two angels at the back.

The largely extended use of terra-cotta ornament from about 1500 to 1540 is indeed characteristic evidence of the presence of the Italian workmen. Terra-cotta as a building material is only a species of brickwork burnt extremely hard and moulded, and in this form it had been in use in England before the Italians came, particularly along the east coast. It is by no means clear, however, that it was used except in a very rudimentary way, and it is not till the beginning of the sixteenth century that this material was used with any mastery. During the first half of that century terra-cotta was freely used for ornament. There are instances at Great Snoring Rectory and East Barsham Manor House in Norfolk, houses which date from the end of the fifteenth and very early part of the sixteenth centuries. The ruined house of Layer Marney in Essex, begun in 1500 and left unfinished in 1525, is another well-known example of the use of terra-cotta detail. Other instances are Sutton Place in Surrey, built between 1521 and 1527, the tomb of Lord Henry Marney at Layer Marney, 1525, and the tomb of one of the Earls of Arundel in the Fitz-Alan Chapel at Arundel. After the Italians left England, the use of terra-cotta ornamentation died out almost entirely. It was still used in the seventeenth century for copings, as at Abbot's Hospital, Guildford, and for pierced balustrades and similar details, but I do not think any instances exist of its use in the elaborate manner practised by the Italians after the end of the sixteenth century.

There is no record of the names of other Italians employed by Wolsey at Hampton Court, but there is further evidence of their handiwork in the ceiling of Cardinal Wolsey's closet, and it is possible that the paintings in this room below the frieze may have been by Bartolommeo Penni or Toto del Nunziata, Italians subsequently in the service of Henry VIII. Both Wolsey and Henry VIII. were munificent patrons of art, and the king was particularly jealous of his reputation as a virtuoso, emulating Francis I. of France in his anxiety to attract the most skilful Italian artists to his court. The most famous of these artists was Torrigiano, or Peter Torry-sany, as the English used to call him. Torrigiano came to England in the company of some Florentine merchants before 1512. The tomb of John Young, 1516, in the Rolls Chapel (now destroyed), was his first completed work in England; but while making this he must also have been employed on the

tomb of Henry VII. in Westminster Abbey, the indenture for which is dated October 26th, 1512. The tomb consists of a sarcophagus of black marble divided by gilded bronze pilasters, on which rest the effigies of the king and Elizabeth of York, his queen, in bronze. In the panels are bas-reliefs in bronze

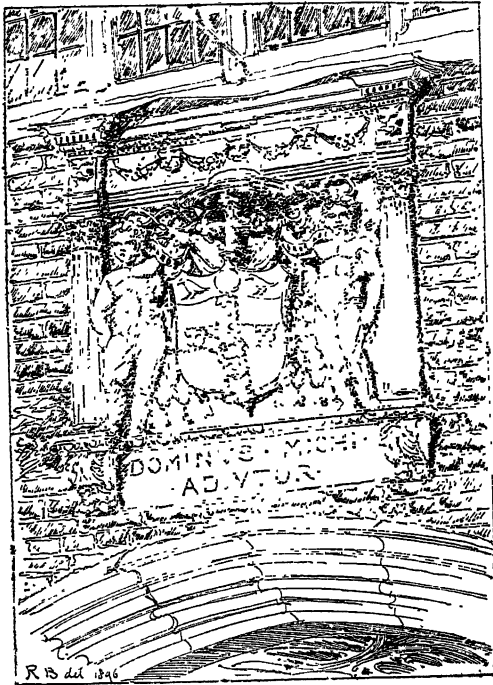

WOLSEY'S ARMS : HAMPTON COURT, TERRA-COTTA.

of the Virgin and Child, the Archangel Michael, the two St. John, SS. George of England, Anthony of Padua, Christopher and Vincent, the Magdalene, and SS. Barbara and Anne. These bas-reliefs are set in wreaths carved out of the black marble. At the ends of the tomb are the armorial bearings of England, France, Wales, and Mortimer. All the details of this

beautiful work, executed in bronze, are unmistakably Italian, and probably executed by Torrigiano himself; but it is almost certain that, in carrying out the accessories, Torrigiano employed English workmen, and the grille is probably English both in design and workmanship. Torrigiano also made some images, "a garnishment and an awlter," for Henry VII.'s Chapel. The contract for this high altar was made March 11th, 1516-17; but Torrigiano did not actually begin work till 1520, on his return to England from Florence, and appears to have completed it by about 1522. It consisted of an altar with a reredos and a flat baldachino of white marble over it, carried by four detached columns of gilt bronze on pedestals of black and white marble. Above the baldachino were set the royal arms, with four terra-cotta figures of angels at each of the angles, holding emblems of the Passion. The reredos was flanked by two pilasters, all in bronze-gilt, and the altar consisted of a black marble slab, supported by square white marble piers at the angles, with gilt bronze balusters between, and within was "a bakyn image of erthe coloured of Christ dede." This altar was destroyed in 1643 by the notorious Sir Robert Harlow, who also broke up the fittings of Hampton Court Chapel in 1645. Vasari, in his free manner, states that Torrigiano executed "infinite works in marble, bronze, and wood," in England. In the south aisle of Henry VII.'s Chapel is his monument to Margaret, Countess of Richmond, who died in 1509. Burges supposed that this was the earlier work of the two; the figure is possibly even finer than those on Henry VII.'s tomb, and the conspicuous ability displayed in both these works led to the next contract which Torrigiano undertook—that for the tomb of Henry VIII. The indenture for this tomb is dated January 5th, 1518, and stipulated that Torrigiano was to make a tomb of white marble and black touchstone for Henry VIII. and Queen Katherine, one fourth larger than Henry VII.'s tomb. It was not to cost more than £2,000, and was to be completed in four years. It is doubtful if this tomb was ever begun at all, as soon afterwards Wolsey ordered his own monument, and after Wolsey's fall this monument was appropriated by the king for his own use. The history of the Wolsey monument will be described later. After signing his contract, Torrigiano returned to Italy to engage workmen, and in September, 1519, he entered into agreements with Antonio

di Piergiovanni di Lorenzo, sculptor of Settignano, and Toto del Nunziata, painter, and in October, 1519, with Jacopo da Verona, binding these artists to work with him for four and a half years, in France, Italy, Flanders, England, Germany, or any other part of the world, for three gold florins a month for the first year, and forty ducats a year for the remainder, with cost of living and horse hire. Torrigiano seems to have returned with his three men in 1519-20, and to have at once begun the work for the high altar, which he appears to have completed by 1522. Vasari says that he went to Spain, and died in the dungeons of Seville in 1522; but Milanesi has pointed out that he actually died in 1528.

The immediate successors of Torrigiano in England were Rovezzano and Giovanni da Majano. The latter has already appeared as the modeller of Wolsey's terra-cotta medallions at Hampton Court. He came of a well-known Florentine family of artists, and was, perhaps, the nephew of Girolamo (died 1490), and Benedetto di Nardo da Majano, the famous intarsiatore, who died in 1497, and of whom Vasari says that he carved a likeness of Henry VII. from a drawing supplied him by certain Florentine merchants. Rovezzano appears to have come to England about 1520. In 1529 he addressed a petition to Wolsey, praying for payment of the balance due to him for an altar and tomb for the cardinal, and also for leave to return to Florence, from which town he had been absent for ten years. Wolsey, whose fortunes were now shattered, was near his end, and probably powerless to do anything; and Rovezzano must have referred the matter to the king, who had already seized the cardinal's monument for himself. Rovezzano obtained his leave of absence, and left for Florence in 1529. On his return from Florence he resumed his work on the tomb, and John da Majano was associated with him. Entries of receipts for payments by Cromwell on the king's account, for labour on the king's tomb, occur in 1531-32-33. The entries continue in 1536 "to Benedict and John, graveurs working upon the King's tomb at Westminster in May, June, July and August, £38. 3¹/₄. 2040 lbs of copper for the tomb, £22. 17¹/₄." I have not been able to discover any entries relating to the tomb, or any mention of Rovezzano or Majano after 1536.

The history of this monument is a strange one. As already stated, it was originally begun for Wolsey; and Rovezzano ap-

pears to have more or less completed it as first designed, at the time of Wolsey's fall. At this date it seems to have consisted of a recumbent figure of the cardinal in gilt bronze, resting on a sarcophagus of black touchstone with gilt bronze enrichments at the angles. The sarcophagus stood on a rectangular base of black and white marble, and at each angle were tall square pillars of gilt bronze 9 ft. high, supporting angels 3 ft. 4 in. high with candlesticks. At the ends of the tomb were figures of boys supporting the cardinal's arms, and at the sides were scutcheons for the inscriptions fixed to the base, with kneeling figures of angels at either end. Twelve small images of saints, 1 ft. high, were ranged along the top of the base to the sarcophagus. When Henry annexed this monument, he determined that it should be a much more magnificent affair. The sarcophagus and base of Wolsey's tomb were taken, but Wolsey's effigy was replaced by one of the king, and the tomb placed on a second base which, in its turn, stood upon a podium 14 ft. 6 in. by 10 ft. 6 in. by 5 ft. high, of black marble ornamented with bronze. Round this podium were placed ten square pillars of bronze, 12 in. by 12 in. and 10 ft. high, supporting figures of apostles 4 ft. 6 in. high, with three smaller figures, 2 ft. 1 in. high, set round the base of each pillar. Between the pillars were eight great candlesticks 9 ft. high. The whole was surrounded by an inclosure of bronze, 4 ft. 6 in. high, set in a framing of black and white marble, of a total height of 5 ft. The latter end of this splendid monument was as melancholy as the beginning. It was left unfinished in the Lady Chapel of Henry VII. at Windsor, when Henry VIII. died, and never completed, though a survey was made for the purpose in the reign of Elizabeth. Charles I. intended to be buried in it; but after his execution Parliament ordered the sale of all the bronze work to the monument, and it was sold in 1646 for something over £400, four of the candlesticks finding their way to the Church of St. Bavon at Ghent. Between 1806 and 1810 the marble sarcophagus and upper base were removed to form Nelson's tomb in the crypt of St. Paul's; and about 1811 the whole floor of the Chapel at Windsor was taken up to form the royal vault for George III., and with this disappeared the last trace of this monument, which had occupied some of the best years of Rovezzano's life. Vasari says that Rovezzano returned to Italy about 1540, his sight having failed through his standing

too near the furnaces while founding metal. He died about 1550. Da Majano probably left England at about the same time as Rovezzano.

In an account for building a banqueting house at Greenwich in 1527 occur items for various paints and oils spent by "Mr. Hans and his company," and of payments to Italian painters and gilders, "Nicholas Florentine at 23^d, and Domyngo at 16^d, day and night; to Vincent Vulp and Ellys Carmyan (also Italian painters) at 20/ the week." Holbein's work was a temporary arch for the pageant of "the Father of Hevin." Vincent Vulp or Volpe painted the banners for the great Harry in 1514, "a streamer with a dragon 45 yards long." Many other Italians and foreigners were in the employment of the king. The most important were Bartolommeo Penni, Gerome da Trevigi, and Toto del Nunziata, all men of independent reputation, apart from their employment in England. On June 26th, 1537, letters of denization were granted to Anthony Toto, painter of Florence, and he was made sergeant painter to the king; but his name occurs seven years earlier, in 1530. In the privy purse accounts is an entry of £18 15s. paid as wages to Anthony Toto and Bartholmewe Penni, painters of Florence, at the rate of £25 a year apiece. Their names occur in November, 1531; after this, Toto is mentioned alone. He was employed by Henry in the works at Hampton Court. Gerome da Trevigi, or Girolamo Penacchi, of Treviso, was employed by Henry chiefly as a military engineer. It is possible that Penacchi gave the general lines for Henry VIII.'s military castles, such as that of Camber. Vasari says that Penacchi was a poor designer, but a pleasant colourist in the manner of Raphael. He left Bologna in anger at the unfairness of a competition for the decoration of the Spedale del Monte, and came over to England, where he was employed by Henry at a salary of 400 crowns a year and a house. In 1544 he was cut in half by a cannon ball while directing the formation of some batteries round Boulogne. Anthony Toto or Toto del Nunziata is said by Vasari to have built for Henry VIII. his principal palace. This palace was probably Nonesuch. In point of fact it is most unlikely that Toto del Nunziata designed this building, but he may very well have been employed on its decoration with many other foreigners.

Nonesuch seems to have been the most important building

erected in England in the reign of Henry VIII. It was built on a manor bought by Henry from Richard de Codrington in 1537. After Henry's death it passed into the hands of Lord Arundel, "who, for the love and honour he bare to his old master," bought it from Mary, and completed the works "for the honour of this realme as a pearle thereof." In 1591 Elizabeth bought it back from Lord Lumley, Arundel's son-in-law. In 1670 Charles II. gave it to Barbara, Lady Castlemaine, who had the manor disparked, and ordered the building to be pulled down and sold as old materials. In 1650 a commission had been appointed by Parliament to survey the buildings, and their report (given in full, "Archæologia," vol. v.) gives a vivid idea of what Henry and his men understood by a royal palace. The palace consisted of two courts; an outer court paved with stone 150 ft. long by 132 ft. broad inside, surrounded by a two-storey building of freestone roofed with slates. This was entered through a gatehouse three storeys high, with turrets at the four angles. Opposite this gatehouse was a second gatehouse similar to the first, except that it was surmounted by an elaborate clock turret. Through this gatehouse a flight of steps led to an inner court, which measured 116 ft. long by 137 ft. broad. The level of this court was 8 ft. higher than that of the outer court. The lower storey of the inner court was of stone, but the upper of half timber work, "richly adorned and set forth and garnished with a variety of pictures and other antick forms of excellent art and workmanship, and of no small cost." This ornament was executed in plaster by Italians. Evelyn, who saw the place January 3rd, 1666, was astonished at the perfect state of preservation of the "plaster statues," and he noted "some mezzo relievos as big as life. The storie is the heathen gods, emblems, compartments, etc." The puncheons, or wooden uprights, were, he says, covered with scales of slate; but Pepys, a not less accurate observer, says (September 21st, 1668), "one great thing is that most of the house is covered, I mean the posts and quarters on the walls, with lead, and gilded." At the east and west outer angles of the inner court were two great towers, facing the Privy Garden, five storeys high. These were covered with lead, and "battled round with frames of wood covered with lead." In the middle of the inner court stood a fountain of white marble and bronze on a flight of three steps. In front of the house was a balus-

trade of freestone, inclosing the forecourt, and round the three outer sides of the inner court was the Privy Garden, surrounded by a wall 14 ft. high, and divided into several "alleges, quarters, and rounds, set about with thorne hedge," and adorned with a fountain of a pelican, and "two other marble pinnacles or pyramids, called the Faulcon perches, betwixt which is placed a fountaine of white marble with a lead cisterne, which fountaine is set round with 6 trees called lilack trees, which trees bear no fruit but only a very pleasant flower." The banqueting house, a square half timber building, three storeys high, containing a hall and eight rooms, with windows on every side, stood on the highest part of the park. Above the third storey was a lantern covered with lead, and at each corner a balcony for the view. The Commissioners of 1650 estimated the gross value of the materials only, after allowing for cost of taking down, at £7,020, and they reported that the building was in very good repair. There is a view of the house in Speed's map of England, but the best print of it is Hoefnagle's large folio made in 1582, for George Braun's "Urbium Præcipuarum Mundi Theatrum quintum." This print tallies pretty closely with the report of the Commissioners, though the bulbous cupolas on the towers are probably a fancy of the draughtsman. The Latin description in the text says: "He invited thither, at the Royal cost, the most excellent artificers, architects, sculptors, and statuaries of different nations, Italians, Frenchmen, Hollanders, and native Englishmen, and these presented a marvellous example of their art in the decoration of this palace, and both within and without adorned it with statues, which here recall in literal reproduction the ancient works of Rome, and elsewhere surpass them in their excellence." It will be noticed that this description expressly limits the work of the foreigners to decoration ("in hac arce ornanda"); they did not design the architecture as a whole. The mention of Frenchmen is also remarkable. The names of French artists or workmen scarcely ever occur in the State Papers, and there are few instances of Renaissance work in England which can be attributed to them. The capitals to the arch between the More chantry and the chancel of old Chelsea Church are an unusual instance. They closely resemble French work of the early sixteenth century, such as is found along the banks of the Seine, between Paris and Rouen. The monument in the Oxenbridge chapel in Brede Church,

Sussex, dated 1537, is another rare example. It is of Caen stone, admirably carved, and was probably made in France and shipped to the port of Rye, some nine miles distant from Brede.

Besides the Italians already mentioned, a certain John of Padua has obtained a position of undue prominence from the fact that his name occurs in a grant from the king, dated June 30th, 1544, of 2s. a day for his services in architecture and music, which grant was renewed by Edward VI. on December 13th, 1547, and June 5th, 1548. No building can be attributed to him with any certainty. He is said to have designed Protector Somerset's palace in the Strand in 1549 (old Somerset House, destroyed 1776-84), and Longleat in Wiltshire, begun by Sir John Thynne in 1567, but there is no evidence whatever to prove this tradition. With the exception of the additions made by Inigo Jones in the following century, the architecture of old Somerset House appears to have followed the methods habitual in England in the middle of the sixteenth century. The stonework of Longleat shows knowledge of Italian detail, but it has none of the distinctive character which marks the work of the Italians imported by Henry VIII. Holbein, who designed architecture and everything else, must be reckoned with the Italians. Besides his innumerable designs for plate and jewellery, he is said to have designed two gatehouses at Whitehall, pulled down in 1770. These resembled Wolsey's gateway at Hampton Court, and are said to have had terracotta busts in niches, and other ornaments in terra-cotta. There is, however, no authority for the tradition that Holbein designed these gateways or the so-called gateway in the Gardens of Wilton. The large drawing of the chimney-piece in the British Museum is a characteristic example of Holbein's design. Shurburne, Bishop of Chichester, employed a certain Theodoro Bernardi in 1519 to paint the pictures of the kings of England and the bishops of the see in Chichester Cathedral. This "Bernardi" was a Fleming, Dirk Barentzen, who settled with his family in Chichester; if, as is possible, he was responsible for the monument to Shurburne in Chichester Cathedral, the treatment of the angels in this monument shows how completely all these imported artists were dominated by the Italian influence.

That the Italians were present in England in considerable numbers in the early part of the sixteenth century is evident;

but in spite of Henry's lavish employment of Italian artists, we cannot point to a single instance of a building of the sixteenth century designed and carried through by any one Italian in England. The evidence on every hand points to the conclusion that they were employed as workmen, and in no sense as architects. At Hampton Court the fabric of the building is purely English in design and execution, and the names of the English workmen are known. Terra-cotta plaques and medallions were

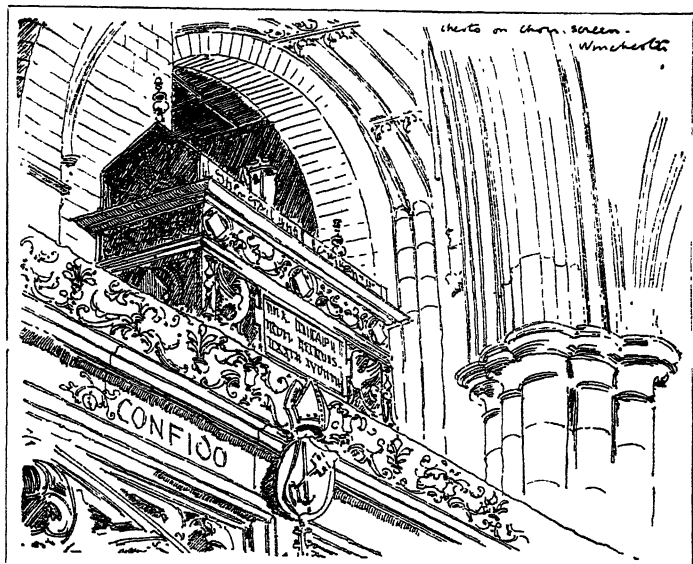

CHEST ON CHOIR SCREEN, WINCHESTER.

merely inserted into the brick walls of an ordinary English building, which indeed architecturally might have been very much better without them. When the English masons had built the screen or the chantry after their own fashion, the Italian carver was called in, and he set to work in his way and incontinently covered the surface with arabesques and cherubs' heads and other fancies brought from his home in the south. Thus in the Chapel built for Margaret, Countess of Salisbury, at Christchurch in Hampshire, probably about 1520, the fan

vaulting, mouldings, tracery, cusping, and crockets are ordinary late Perpendicular, whereas the sides of the engaged shafts, the spandrels and other details, are distinctly Italian not only in design, but in the extreme finish and delicacy of their execution. The screen in the south chapel of the choir is another instance. So too in the chantry and tomb of Stephen Gardiner, Bishop of Winchester (died 1535), there is a similar mixture of English Perpendicular masonry and Italian surface sculpture. The vaulting of the chantry is Perpendicular, but at the east end is a little reredos of three niches with Ionic pilasters. This instance is even more remarkable than that at Christchurch. Above the four light windows with Perpendicular tracery in the heads runs an entablature of the Doric order, with triglyphs, discs, and oxens' heads in the frieze. All the work is clearly of one date, but two sets of men must have been employed on it, with the result of a curious uncertainty as to which set of details was to be followed. The ceiling and details of Bishop West's chapel at Ely (about 1533) illustrate clearly this struggle between the old tradition and the new detail, and I think it is evident that Henry and other princely patrons of art treated the Italian as a very humble person, not to be intrusted with large designs, but as fit only to take his place with other workmen in the execution of one particular piece of ornament. Torrigiano, Rovezzano, or Holbein might be allowed more freedom, or the whole contract for a magnificent piece of work, such as the screen at King's, Cambridge, might be given to an Italian carver of admitted reputation; but the panels at St. Cross, near Winchester, and those round the choir at Christchurch, represent the ordinary employment of the Italian under Henry. In the latter instance the Italian carver appears to have competed with Flemish, and possibly French, workmen, probably all three coming out from Southampton to pick up any work they could in the neighbourhood.

Another noticeable point about this early work of the Italians in England is its local character. With exceptions in the east of England, it was pretty well confined to the districts that lay between London and the south coast ports, particularly Hampshire; and the prevalence of Italian work in this part of England is no doubt to be attributed to the settlement of the Italian merchants at Winchester, and the constant passage of foreigners between that town and the port of Southampton. The models

for the terra-cotta detail at Sutton Place, near Guildford, were probably supplied by Italian workmen. Italian carvers were employed by Lord Sandys for his new buildings at the Vyne, near Basingstoke. Round the canopy above the stalls in the chapel there is a running band of foliage on which are amorini blowing horns, shooting at stags, hunting goats, and owls playing flutes and drums in and out of a branch of pomegranate.

This, though on a very small scale, is a charming example of the mixture of Italian motives with the traditional Gothic feeling, of the state of mind characteristic of Tudor England in its curious interest in the New Learning, side by side with its invincible affection for the fancies of mediævalism.

The conclusion to which a survey of existing evidence leads is that the direct influence of this first advance of the Italian Renaissance on the development of architecture in England was not considerable. Its area did not extend far beyond the southern

counties, and it was an affair of detail of all sorts, of ornamentation of surfaces, of delicate arabesque and dainty plaster modelling, of terra-cotta medallions, and beautiful carving in low relief and absolute drawing, rather than of architecture in a large and comprehensive sense. Possibly the Italians were not given the chance, yet it is hardly a matter for regret that the solid tradition of English building was not abandoned as yet for an architecture which in its pure Italian form was un-

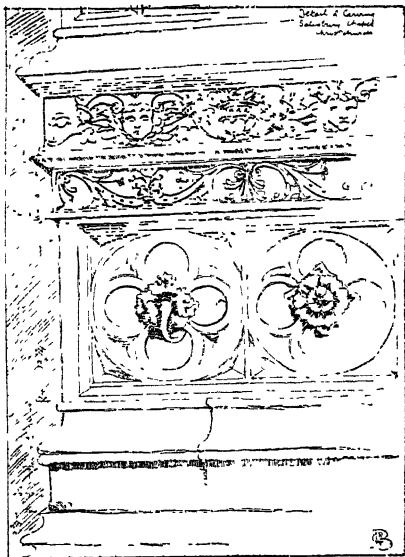

FROM THE SALISBURY CHANTRY, CHRIST-
CHURCH, HANTS.

suiting to the conditions of our climate. At the same time the indirect influence of the Italians must not be underrated. The mere fact that men of the ability of Torrigiano, Rovezzano, and Majano were working in England for several years must have had its effect on the native workmen among whom they worked, and must have done something to familiarize these workmen with Italian detail and its very high standard of workmanship. The plaster work on ceilings and friezes which became so common towards the end of the sixteenth century is usually assigned by local tradition to travelling companies of Italians. The inferiority of workmanship and the character of the design show clearly that it was executed by Englishmen long after most of the Italians had left this country. But that it was inspired by the specimens of plaster work executed by the Italians in the time of Henry VIII. is very probable, and some of the Englishmen very early picked up the new manner. For instance, when Henry VIII. built the hall of Hampton Court, Richard Ridge of London carved the great pendants under the hammerbeams of the roof, and, though the roof is of ordinary late Gothic construction, the details of these pendants are of comparatively pure Renaissance character ; and here, as in the carving at the Vyne, we see how the influence of the humanist was winning its way over the harsher fancy of the later Gothic tradition. This influence was as yet solvent rather than synthetic. It broke up the ground for new ideas ; at its higher level it prepared the way for the maturer architecture of Inigo Jones, at its lower, for all that charming play of simple fancy which marks the best English craftsmanship of the sixteenth century, for the new half pagan delight in all rare and beautiful things which gives to the Renaissance its undying interest as one of the recurring outbreaks of humanity against the tyranny of another world

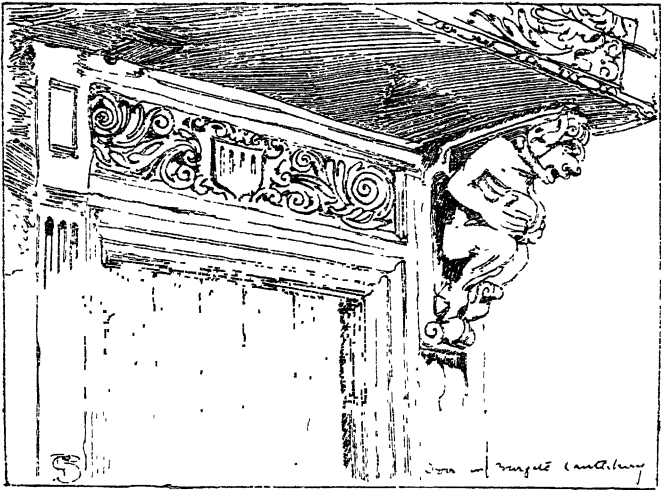

DOOR-HEAD, BURGATE STREET, CANTERBURY.

CHAPTER II

THE GERMANS IN ENGLAND—ELIZABETH-JAMES I

THE death of Henry VIII. marks a turning-point in English history. The end of his despotism was as the end of a long nightmare; and henceforward the English instinct asserts itself with increasing strength, not so much in the details as in the essential elements of architecture.

For various reasons the Italians gradually retired from this country after the death of Henry VIII. though the change of religion in 1536 does not appear to have immediately affected the commercial relations of Venice with England. In 1548 Daniel Barbaro, who subsequently translated "Vitruvius,"¹ was appointed Venetian ambassador in England; but he only stayed in England eighteen months, and was ordered to return to Venice towards the end of 1550. From the date of Elizabeth's

¹ Printed at Venice, 1567.

accession to 1570, the Venetian traders in London were represented by a vice-consul. Between 1570 and 1575 there were no regular diplomatic relations with Venice, and they were not resumed till the accession of James I. Pius V. in fact made every effort to induce all Roman Catholic powers to break off relations with England, and thus, owing to the drift of political affairs, the Venetian trade with England gradually disappeared. The patronage of the Bardis and Cavalcantis passed into the hands of Flemish merchants, and after Edward VI. we find little trace of Italian artists. The numerous foreigners who came to England during the reigns of Elizabeth and James I. were nearly all natives of Germany and the Low Countries.

Another reason for the disappearance of the Italians was the poverty of Edward VI. Whereas Henry VIII. had begun Nonesuch, and the palaces of St. James's and Whitehall, and had spent vast sums in completing Hampton Court, neither Edward VI. nor Mary ordered any new building of importance. The utmost that Edward was allowed to do was to maintain his father's pensions and keep his palaces in repair. His father had left him burdened with debts, and a coinage so debased that plated copper was circulated as silver. There was therefore little likelihood of employment for the Italians, and the small outlay made to rehabilitate the old religion under Mary was hardly a sufficient inducement to them to stay. We have now to turn our attention to the invasion of German and Flemish workmen who succeeded the Italians in England, and to the native builders who at first worked side by side with the foreigners, and eventually superseded them.

When Elizabeth began to reign, the architect, as we now understand him, had not yet detached himself in England as an independent designer from the general body of craftsmen. He was still in the position of the master mason or carpenter who contracted for his own particular trade, and in this capacity provided his own details, either designing them himself, or using stock patterns, such as "the broadleaf and the rose, the rose and the garnet, the leaf, the double ring, the double flower, the great pillar, the little flower, the two dolphins and the little pillar." The building owner, the "client," to use the modern term, gave general directions as to what he wanted, probably including a rough ground-plan, though many of these were made on the spot by the foreman, as in the old accounts occur

“skins for making platts” (plans). The work was carried out partly by contracts with separate trades, partly by day work, the owner usually providing all materials, and the workmen being employed by agents, who are called variously “surveyor of the works,” “comptroller of the works,” “clerk overseer of works,” “clerk of accounts,” and “clerk of the check,” who appear to have divided among themselves the work now done by the builder’s clerk, the builder’s foreman, and the clerk of the works. The one person who is never mentioned at all is “the architect.” To modern notions the business of building operations in the sixteenth century seems to have been conducted somewhat loosely. Rough contracts were made with the different trades, and after that the trades were left to themselves to supply the designs and to execute the work, though there was often a foreman designer, such as Arnold at Wadham, or Cecil’s man at Burghley, and each trade was directly responsible to the employer. No drawings, except the roughest possible sketches, were prepared, and the specifications, beyond giving general dimensions and naming materials, tended to leave the rest to that convenient clause of the modern specification, “everything to be the best of its kind.” In regard to materials, the practice varied: sometimes these were found by the trades, sometimes by the employer. At Clare, Cambridge, for instance, in 1635, the Bursar bought brick earth and had bricks made for the college, at a price of sixpence per M for the brick earth, though later on he bought the bricks at five shillings per M. Wainscot, deal, and fir were bought from King’s Lynn, stone from Ketton and Welldon, slates from Collyweston, and lead from Derbyshire. All these were supplied by the college, and the “work was carried on either by day work, or by small bargains for particular jobs” (Willis and Clark). The history of Clare shows how tenaciously the system was adhered to. The buildings were resumed in 1669, after the Restoration, and the beautiful river front of Clare and the bridge were completed under Robert Grumbold, Freemason, who, it appears, not only made the designs, but was employed on the works as a working mason. In 1685 he was receiving twenty shillings a week for designs and for his work as mason, the college still finding all materials.

Where the trades found their own materials some form of contract was always made. In Messrs. Willis and Clarke’s

History¹ there is given in full the contract between the Master and Fellows of St. Catherine's Hall, Cambridge, and John Atkinson, dated April 18th, 1611, to erect a good and substantial range of buildings as below specified: the house to be two storeys high, each 9 feet from floor to ceiling, the studs to be 12 inches apart, and the width "18 feet from the inside of the brickwork unto the outside of the groundsill"; the case of stairs to be large enough to contain "a fair paire of staires up to every of the 6 roomes," each room to have a fair bay on the college side, with one at the end, and convenient lights on the other side, "the windows to have fourteen iron casements placed in the most convenient places, and all to be coloured with white lead and oil"; each room to be divided into a study and bed-chamber, "with sufficient doares, locks, hingells and stapells"; the floors to be of good oak or deal, the rooms to be ceiled with lime and hair. Jo. Atkinson is to make two chimney-stacks with three fires in each stack, and to remove the old buildings, the whole to be completed within twenty days after next Michaelmas, and the builder to be paid £60 at the time of sealing, and a hundred marks on October 22nd, or £126 13s. 4d. in all, and to have the old materials, and "the said Jo. Atkinson covenanteth that all and every the timber wh. shall be used in the said buyldynge shall be sound, firm, stronge and of a good scantlinge, and all the stone tyle glasse iron mortar brick and whatsoever thing else is necessary shall be of the best for continuance, and to make it a strong seemly buyldynge and habitable." No drawings were given, and no other specification than what is contained in the above, and the building lasted till 1673, when it was rebuilt by Grumbold.

It is evident that as yet no necessity was felt for a trained designer in building, and this method of designing and executing buildings continued in common use till the end of the sixteenth century, and was not abandoned generally till the middle of the eighteenth. So long as son succeeded father with an uninterrupted tradition of methods of workmanship the system answered admirably; but when, as was the case in the latter part of the sixteenth century, all kinds of new motives were introduced, there was clearly need of some person of wider

¹ "Architectural History of the University of Cambridge," vol. ii., p. 90.

knowledge and more discerning taste to control the aberrations of the workmen. No such person had yet emerged, and the



DOORWAY, TENTERDEN, KENT.

consequence was that, though the work of this period is nearly always picturesque, it is marked by extreme ignorance of the scholarship of architecture, the orders are grouped and separ-

ated and inverted with a singular disregard of the recognized canons, and the proportions followed no rule but that of the builder's inner consciousness. Where the builders dispensed with ornamentation they were still capable of doing excellent plain work, such as parts of Knole, some of the colleges at Oxford and Cambridge, and many a quiet manor-house. Occasionally one comes across instances which display greater learning but less originality, such as Longleat, but most of the important buildings carried out in the reign of Elizabeth are wanting in distinction. Though picturesque in outline—the legacy of the Gothic tradition—they are overcrowded with abominable ornament, they bear evident marks of having been designed by men without any great knowledge of architecture, men who were destitute of a taste sufficiently mature to save them from the silly extravagance of the Germans. The result would probably have been even worse, except that the nobleman of that time had actually some knowledge of architecture, and there did exist a genuine liking for art, and a general level of taste which was certainly higher than it is at the present day.

The building schemes of Protector Somerset were cut short by his execution in 1552. His palace, afterwards Somerset House, was begun about 1547-48, and it appears that between April, 1548, and October, 1550, £10,091 9s. 2d. had been expended on the building; and it was charged against Somerset as early as October, 1549, that he was heaping up money and building himself great houses, and "leaving the King's poore souldiers unpaid of their wages."

Little was done in the reigns of Edward VI. and Mary, though perhaps the faith of the latter may have arrested for a time the slow decay of Gothic architecture. Charlecote in Warwickshire, begun in 1558, the year of Elizabeth's accession, is the earliest of the famous Elizabethan manor-houses. The first record, however, of any considerable undertaking, after Edward's death, is the letter from Roger Warde, mason at Burghley, to Sir William Cecil, desiring instructions as to the building of three "lucan" windows for the inner court, and for the stairs from the base-court to the terrace, and for the gate at the end of the terrace. In 1561-62 Peter Kemp sends Cecil a plan of the brew-house, and various building accounts to be settled. In August, 1561, John Shers writes to Sir William

Cecil that he has purchased for him at Venice the statues of twelve of the emperors. Under date February 19th, 1567 (State Papers, Domestic, Elizabeth), there is a note of certain "works of art, of marble jasper," brought into England for Sir William Cecil and the Earl of Pembroke by Dominique Troisrieux, a Frenchman, those unsold to be returned duty free. In 1570 Sir T. Gresham is writing to Cecil that his pillars of marble have arrived in good order from Hamburg, and on April 5th, 1571, Casper Vosbergh reports the progress of the works at Stamford. These entries enable one to form some idea of the manner in which such a house as Burghley was built in the time of Elizabeth. There is no mention of any architect or general contractor. The work began with the English mason who applied directly to Cecil for instructions. Meanwhile Cecil had his agents abroad, on the look-out for choice marbles and statuary, and finally, after fifteen years of building, the German appears on the scene, probably for carving and ornamental detail, and perhaps accompanied by a staff of German workmen, for in 1572 Vosbergh petitioned Cecil (now Lord Burghley) for privileges for a German Church to be founded at Stamford. The noticeable points are: (1) the absence of any trained designer to control the whole; (2) the leisurely manner of building: these men thought nothing of spending fifteen to twenty years over a house—Longleat, for instance, begun in 1567, was not finished in 1580; (3) the introduction of German workmen to ornament the building: where Wolsey would have employed Italian workmen, Burghley employed German.

About this period the Germans and Flemings came over to England in considerable numbers. The powerful corporation known as the Steelyard had been in existence since 1296, and, in spite of the protest by the English merchants in 1552, the merchants of the Steelyard continued to flourish till the end of the century, and it was not till 1601 that Elizabeth finally ordered their expulsion. Various settlements of Flemish weavers were started about the middle of the sixteenth century with special privileges. There was one at Glastonbury, under special articles entered into with Protector Somerset; another at Barcheston in Warwickshire; and at Colchester and other places along the east coast of England there were colonies of Dutch and Flemish artisans. There were similar settlements

in the Isle of Thanet and in the Weald of Kent. In 1561 a warrant was issued to Sir Nicholas Bacon for a grant to the Mayor of Sandwich, allowing the settlement of a number of foreigners in Sandwich. The wording of this warrant is significant. The settlement was permitted "as well for the helpe, repaire, and amendment of our said town and porte of Sandwich by plantynge in the same men of knowledge in sundry handycrafts, as also for the relief of certaine strangers now resyding in our said cite of London being verye skilful therein." The number was limited to twenty-five households of from ten to twelve each, and all the names given are Dutch. All these men were industrious artisans, and undoubtedly had some influence on the vernacular architecture of the districts in which they settled, as is evident from the resemblance of the brick buildings of the Isle of Thanet and the eastern counties to Dutch architecture of a rather earlier date. This, moreover, was no new thing. It seems certain that the extreme richness and delicacy of detail found in many of the mediæval churches of the eastern counties had its origin in the constant intercourse between the traders of King's Lynn and the east coast seaports, and the great cities of the Netherlands.

This large importation of foreign craftsmen had its effect on the details of Elizabethan work. Not only were designs obtained from abroad, or from foreign pattern-books, but Flemish or German workmen were often brought over for important buildings, as at Burghley and Sir Thomas Gresham's Exchange. The design for Gresham's Exchange is said to have been supplied by Henry de Pas, who subsequently designed the *Hôtel des Villes Hanséatiques* at Antwerp. The building was begun on June 7th, 1566, and was not completed in 1570. It consisted of a square quadrangular court of two storeys and an attic, with a colonnade of semicircular arches on the inner side, and was paved throughout with black and white marble. Over each arch was a niche, with a life-size statue of a king or emperor. To the right of the entrance was a lofty clock tower, with two projecting galleries and an open cupola, surmounted by a gigantic grasshopper, the crest of the Gresham family. Grasshoppers, probably in lead or copper gilt, and suggested, no doubt, by the magnificent vanes of Holland, were placed as finials at the ends of the roof ridges. The building was of brick, with stone dressings, and, on the whole, of a reasonable

and unpretentious character, rather Dutch than German in feeling. The lofty clock tower closely resembled the towers of many a Dutch town hall of about the same period. The building was consumed in the fire of London, and was replaced by a sumptuous building of Portland stone, which was also burnt in 1838. Had all the buildings in England which were built under German influence been equally sane, there would be less reason for regretting this element in the development of English art.

But throughout the reign of Elizabeth the German influence was in the air and predominant. The screens and mantelpieces of old Charterhouse, of Longleat, and of Hatfield, the ponderous entrance porch of Audley End, the strapwork gables to the towers of Wollaton, the barbarous notion of using columns as chimneys, the shapes of men and women ending in balusters, all show the heavy hand, the merely mechanical instinct, of the German workman; and architectural design being at a low ebb at this period, or being rather, one should say, in an undeveloped state, people who built houses had recourse to that last refuge of the destitute, the pattern-book, that is, folio pages of design done into space, designs not made in relation to specific conditions, but made as merely academical or commercial exercises by some facile designer of tailpieces and title-pages. Such was the "Architectura" of that exuberant draughtsman, J. V. Frisius, or Vrese, of Antwerp, published in 1563, a book which was used with disastrous readiness by the English builders of this period; and it was unfortunate that the treatises most in use in England at this time were German rather than Italian. Such obscure persons as Cammermayer and Wendel Dietterlin were preferred to Alberti and Palladio; and the various superb Italian editions of "Vitruvius" seem hardly to have been known in England till the end of the sixteenth century. It is evident, in fact, that the English builder-architect of the time of Elizabeth was a somewhat ignorant and ill-educated person, and did not follow better models for the simple reason that he was unconscious of their existence.

The "Porta Honoris" at Caius, Cambridge, is a good instance of the confusion in which this practice resulted. In itself it is not a bad design, but in the position in which it stands it is mean and disappointing, being totally out of scale with the surrounding architecture. It has even been suggested that the builder mistook the scale of his drawing. The design of this

was long attributed to Theodore Haveus of Cleves, "artifex egregius et insignis architecturæ professor," as he is called in the college books, acting under the direction of Dr. Caius. But Messrs. Willis and Clark say that there is no foundation for this, and that the only work which can be assigned to Haveus was a curious stone column having sixty facets to act as sundials, and adorned with the names of all the gentlemen then in residence at Caius, and a figure of Pegasus as a weather-cock at the top. This column has been destroyed. There is a similar monument on a smaller scale in the quadrangle of Corpus College, Oxford. Another instance of German influence is the centre façade of the entrance front of Longford Castle in Wilts.

The Germans continued to find employment in England till they were routed by Inigo Jones, but towards the end of Elizabeth's reign their principal work consisted in the making of monuments and chimney-pieces. Instances of the latter are to be found in nearly every Elizabethan house of any importance. There are elaborate examples at Hatfield, South Wraxhall, Loseley, Cobham, Blickling, the Charterhouse, and elsewhere. The finest series in any house in England is probably to be found at Knole. Several of the Knole chimney-pieces show undeniable vigour and originality in design, and a sense of proportion not common in German work. The marbles are well combined, and the general effect is sumptuous and magnificent, if lacking in the well-ordered simplicity of fine Italian work. The Knole series, however, is exceptionally fine, and by no means represents the average level of the Elizabethan mantelpiece. The details of the latter are frequently coarse, and even ridiculous, and the incessant repetition of the same trick of design suggests the hand of the tradesman rather than of the artist. The chimney-pieces usually consist of columns of various orders superimposed, and separated by bold projecting mouldings, with rich carvings of arabesques and armorial bearings on the panels and entablatures. The tombs have also a strong family resemblance. When detached, they begin with a marble pedestal tomb on which the effigy rests surrounded by marble columns, usually of the Corinthian order, carrying a rich entablature with an open arcade in the centre. Where the monument was fixed against a wall, the back of the arched canopy was filled with a cartouche containing the inscription, and fruit, flowers, ribbons, and other conventional ornaments

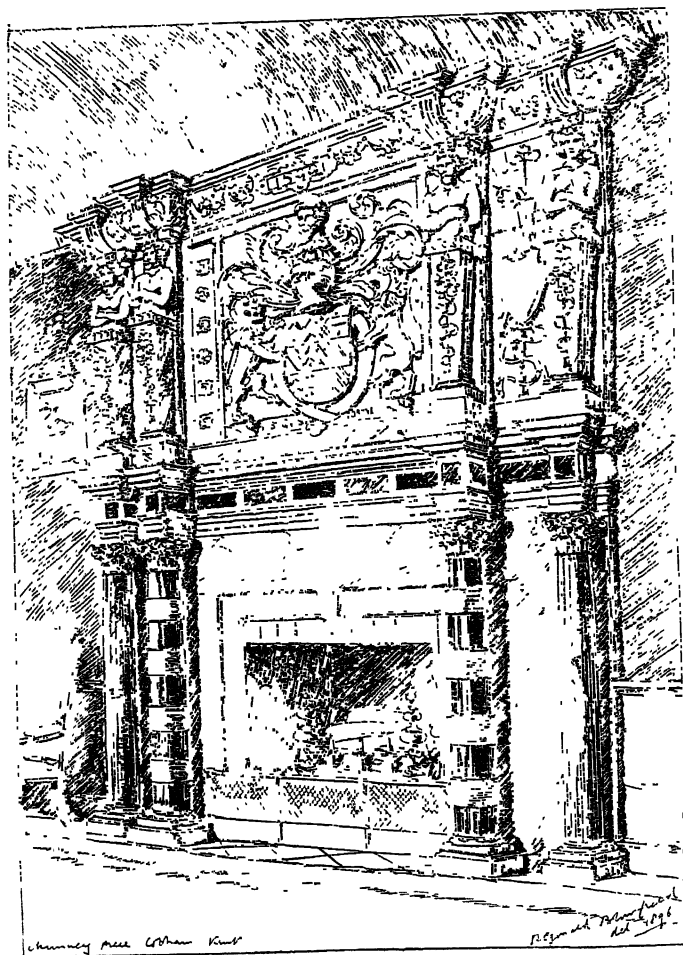

CHIMNEY-PIECE, COBHAM, KENT

The chief difficulty with the designer seems to have been where to stay his hand ; for he continued above the cornice with shields and cartouches, heraldic beasts and obelisks in unrestrained prodigality. The figures and the armorial bearings were usually gilt and coloured. In spite of the narrow range of their design, these monuments are certainly fine pieces of workmanship. The marbles and alabasters are skilfully managed ; the details of the carving and the low relief of the arabesques are often executed with delicacy ; and in some instances, such as the monument to Lord and Lady Dacre (died 1595), in Chelsea Parish Church, the figures are carved with restraint and genuine feeling. The most important instances are : the monument to Elizabeth in Westminster Abbey, erected in 1604 ; the monuments to Mary, Queen of Scots, Westminster, and to Radcliffe, Earl of Sussex at Boreham Church in Essex, executed by Richard Stevens, a Dutchman ; that of Carey, Lord Hunsdon, at Westminster ; the Hertford monument in the Lady Chapel at Salisbury ; and the tomb of Sir Laurence Tanfelde (1625) in Burford Church. In fact, most of our English cathedrals possess sumptuous monuments of marble, black touchstone and alabaster, designed in this manner, which continued in use down to the Restoration. The small seventeenth-century mural monuments of alabaster and other marbles, to be found in most parish churches, are in some ways the best examples left in England of this particular branch of design.

Bernard Jansen, a Fleming, is said to have been employed at Audley End and at Northumberland House. He certainly worked with Nicholas Stone on Sutton's monument in the old Charterhouse Chapel, probably supplying the architectural details while Stone did the figures. The last of these foreign designers, whose work was based on German models, was probably De Caux, a Gascon, and drawing-master to Prince Henry. De Caux did a good deal of work till superseded by Inigo Jones. He built a picture gallery for Prince Henry at Richmond, and laid out the gardens at Wilton, as appears from his book of folio designs, published in 1615, and certainly had something to do with the buildings, but what he actually did is obscure. De Caux was also employed at Heidelberg. Aubrey says he died about 1656.

The influence of German art in England had run itself out nearly twenty years before. The effect on English architecture

was greater for the time than that of the Italians, but it was less permanent in its results. German motives were freely adopted

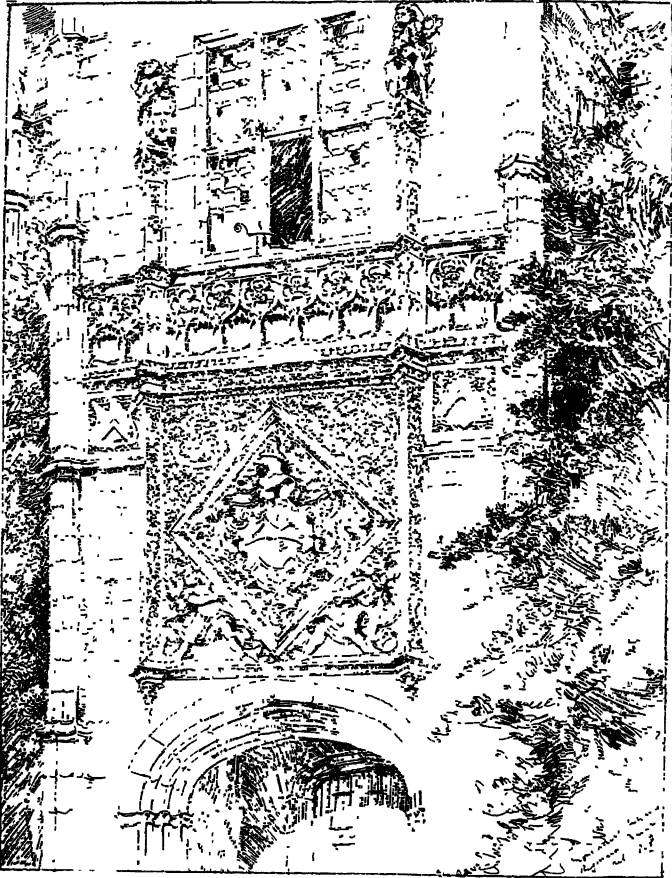

GATEWAY, MONTACUTE HOUSE, SOMERSET.

by English builders in regard to the elevations and architectural details of important buildings. Their crudeness and mechanical method made these motives peculiarly easy to reproduce in

large quantity at an inconsiderable cost. In consequence of this, for one piece of ornament that can be traced to an Italian motive, there are twenty that are clearly due to German influence, in Elizabethan and early Jacobean buildings. That this influence, however, had not sunk very deeply into the minds of the English is evident from the ease with which Inigo Jones threw it overboard; and it did not reappear again in England so long as the development of architecture was spontaneous and traditional, and, though not unconscious, was not the result of deliberate eclecticism.

Moreover, the earlier Italian influence was not wasted. Houses were built in England by gentlemen of less degree, but superior taste, which in the main adhered to the traditions of English house-building, and in their ornamentation deliberately followed Italian models. The beautiful panel above the entrance porch to Montacute House (1580-1600), Sir Thomas Tresham's buildings in Northamptonshire (1575-80), the details of the entrance garden door to Shaw House, near Newbury (1571), show no trace of the Germans at all; and indeed, the refinement of detail, the all-pervading simplicity and reserve of such a design as the entrance front of Montacute, or Barrington in Somersetshire, are plain evidence that the saner traditions of English building were not materially affected by the eccentric German. The elevations of Littlecote (about 1580), with its sober brick front running up uninterrupted to the great eaves course, and its multitudinous gables on the garden side are absolutely and solely English. They might, indeed, have been built a hundred years earlier, and, as will be pointed out, the essential parts of the English house, its plan, and the blocking out of the building were as yet not modified at all by either Italians or Germans. The traditional English house-plan attained by slow development through successive phases of civilization, held its own alike in the palace and the manor-house, in spite of the fantastic foreign dress with which the builder's ambition clothed it.

The real and essential change in English architecture, the change which altered not merely its detail, but its whole intention in building, is not to be found in these experiments of the sixteenth century, but in the far-reaching revolution introduced by Inigo Jones, the first Englishman to grasp in its full significance the art of the Italian Renaissance.

CHAPTER III

THE ENGLISH BUILDERS

OF the English master builders themselves, of the men, that is, who were not quite what we now understand by builders, and still less what we understand by architects, very little is known. The most familiar name is that of John Thorpe; yet in fact the history of his life is almost entirely conjectural, and is based on the miscellaneous collection of drawings now in the Soane Museum. This collection comprises some two hundred and eighty sheets, and includes plans of several of the most notable houses built in Elizabeth's reign, Somerset House, Buckhurst in Sussex, Copthall, Wollaton Notts, Burghley juxta Stamford, and Burghley-on-the-Hill, Sir Walter Cope's house at Kensington (that is Holland House), a great house at Wimbledon for Sir T. Cecil, Longford Castle, Holdenby, Audley End, "Ampt-hill old house enlarged by J. Thorpe," "Kerby whereof I laid the first stone 1570," Loseley in Surrey, Aston Hall, Birmingham, and other less famous houses. There are various reasons which make it improbable that Thorpe had anything to do with any but a few of these houses. In the first place, if Thorpe really designed all these buildings, he must have been better known, whereas only one reference to him has been discovered in contemporary literature, and his name was first mentioned by Horace Walpole, who saw this collection of drawings when it belonged to the Earl of Warwick, and without inquiry jumped to the conclusion that he had found in Thorpe the architect of all the great Elizabethan houses. In the second place, so far as has at present been ascertained, in no case where documentary evidence, apart from drawings, exist in regard to the building of the house, does Thorpe's name occur. Thirdly, very few of the drawings are signed, and there are wide differences of writing and draughtsmanship in the various drawings of the

collection. Lastly, there is the internal evidence of Thorpe's own manner, in so far as it can be gathered from the few drawings in the collection which can be assigned to him with any certainty. If, for instance, Thorpe designed Kirby in Northamptonshire, it is most improbable that he also designed a house of such a very different kind as Wollaton—for though it is easy nowadays for a designer to imitate any quantity of styles, at the end of the seventeenth century neither the necessary knowledge nor the inclination existed for such extreme versatility of design.

It is probable, though by no means certain, that Thorpe designed the plan of the original house at Kirby in Northamptonshire. This house was built between 1570 and 1575 for Sir Humphrey Stafford, and on his death it was sold to Sir Christopher Hatton. The plan in the Soane Museum varies considerably in detail from the plan as actually executed, but the general resemblance between the two is unmistakable, and so far is valuable as enabling us to form some sort of conjecture as to the kind of work which Thorpe may actually have done.

Holdenby in Northamptonshire, built for Sir Christopher Hatton before 1580, is, with the exception of part of the front, destroyed. The only reason for assigning it to Thorpe is that there is a plan and elevation of it in the Soane Museum; but the research of the late Mr. Wyatt Papworth has proved that Thorpe only surveyed this building after it was built, and this is also the explanation of the plan of Burghley juxta Stamford and of Ampthill—in the latter case the words "enlarged by J. Thorpe," on the plan in the Soane Collection, therefore probably mean, drawn to a larger scale by J. Thorpe. Confining ourselves to work which has been assigned to him on some reasonable authority, we are reduced to the Lyveden new building, erected before the end of the sixteenth century on a very curious plan, Longford Castle, some unknown work at Paris, the earlier part of Holland House, and another freak of design, the monogram house made on the plan  and explained by a rhyme,

"Thes 2 letters | & T
Joyned together as you see.
is meant for a dwelling house for me."

This plan is accompanied by a perspective elevation of the

house, which is of an unpretentious character, three storeys and an attic, with octagon buttresses at the angles, such as are common in the plainer sixteenth-century houses, and simple gables not unlike those at Knole. Lyveden new building was built by Sir Thomas Tresham, who also built Rothwell market-

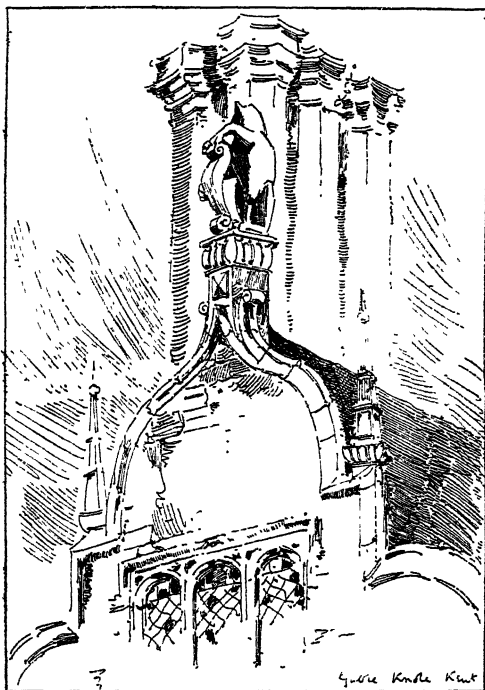

A GABLE AT KNOLE.

house, and the manor-house and triangular lodge at Rushton. A plan, resembling that of the Lyveden new building, occurs in the Soane Collection, and it has thence been inferred that Thorpe was the architect of all Sir Thomas Tresham's buildings. The internal evidence is, however, quite against this view. The designs of the buildings at Lyveden and Rothwell

show unusual refinement of taste and technical knowledge, and can hardly be by the hand that designed Kirby and Rushton manor. If Thorpe designed any of these buildings, the probability is that he designed Kirby and Rushton manor only. The designs for the Lyveden and Rothwell buildings and for the triangular lodge at Rushton were probably made by Sir Thomas Tresham, who was a man of considerable ability and eccentric tastes.

Longford Castle, in Wiltshire, presents a similar difficulty. The building itself was begun in 1580 by Sir Thomas Gorges on the site of an older house, and at the desire of Lady Gorges, who was a Swede, the house was to imitate the Castle of Uraniberg. It was probably finished by the beginning of the seventeenth century, since which date it has been considerably altered and enlarged. The peculiarity of its plan is that it is based on a triangle. At each apex stands a circular tower with buildings connecting the towers and inclosing a small triangular court. The three angle towers (or rather two of them, for the third has been rebuilt) are plain buildings of stone, and the wall face is divided into oblong panels by bands of white stone and black flints alternately. The towers are in three storeys, divided by string courses with a parapet wall above, and the centre string course has a frieze with triglyphs set about four times their width apart. So far this work was English, and even local English, for the pattern formed by the mixture of stone and flint is characteristic of this part of Wiltshire. Moreover, the curious parapet course and the profiles of the strings are not uncommon in English work of this date. But after the building of these towers there must have been an abrupt change in the plans. For instead of the simple gabled front of flint and stone which would have naturally followed these towers, Sir Thomas Gorges indulged himself in an extravagant stone façade of arches and pilasters and terminal figures in the worst manner of the Germans. This façade was built without any regard to the angle towers, the heights and mouldings of which are entirely ignored. It is known that there is a break in the history of the building, Sir Thomas Gorges' money having run out; but after the defeat of the Armada, Lady Gorges obtained a grant of the wreck of one of the Spanish ships, which happened to contain a quantity of bullion, and on the proceeds of this the building was resumed, and very probably a fresh design was

The Palace of Audley End.
 A. The great Hall.
 B. The great Hall.
 C. The great Hall.
 D. The great Hall.

The Palace of Audley End.
 A. The great Hall.
 B. The great Hall.
 C. The great Hall.
 D. The great Hall.

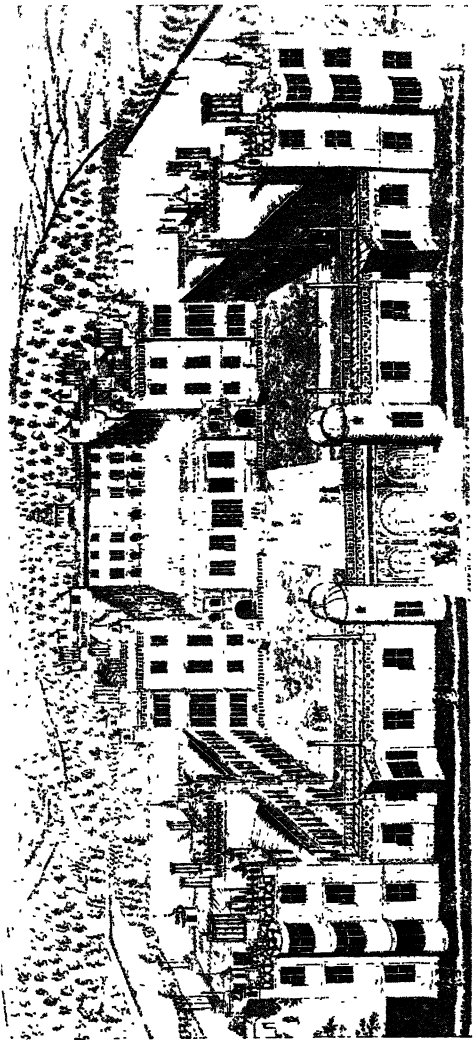

From H. Winstanley's "Audley End."

THE PALACE OF AUDLEY END.

obtained on a more extravagant scale. The plan and elevation of Longford Castle in the Soane Collection do not tally with the present building, and an examination of the building and comparison with the drawings lead to the conjecture that John Thorpe, or at least an English designer, did actually design the ground-plan, and that the towers and possibly the greater part of the fabric were executed from this design, but that he had nothing to do with this entrance façade, which is later in date and utterly different in manner from the original design. On this view of it, the plan and elevation in the Soane Museum must be taken, not as the designs for a new building, but as surveyors' drawings made after the building was completed.

Burghley House has already been referred to. No mention of John Thorpe occurs in any of the documents relating to this house, whereas Germans are mentioned in connection with the building, and their influence is indicated by the curious clock tower in the courtyard, with its unusual and quite foreign feature of a high square steeple above the clock. Burghley shares with Kirby the absurdity of using the Doric order to form chimney-stacks, an affectation characteristic of the later work of the sixteenth century. If Thorpe was employed on this building, it could only have been in a subordinate capacity and not as architect.

Audley End was built for Thomas, 1st Earl of Suffolk. It was begun in 1603 and completed in 1616, and was one of the largest buildings of the kind in England. It is said to have cost £190,000 (in the money of the time), mainly procured from Spanish bribes, and to have been built on a model obtained in Italy. As against this latter story we have the evidence of all the detail, which is obviously German where it is not English, and the evidence of the plan, which shows the usual English arrangement of courts, and included a gallery which ran along the outer court. The details are clumsy, and unlike the details either of Kirby or of Sir Thomas Tresham's buildings, and there is practically no evidence for assigning the design to Thorpe.

The collection also contains a plan and part elevation of Wollaton. This, however, was probably designed by Smithson. Thorpe seems to have spent some time in Paris about 1600. One of the drawings is inscribed "Queene mother's house, Faber St. Jarmin alla Parie, altered per J. Thorpe"; and there

is also a drawing of Monsieur Jammet's house in Paris. Thorpe's employment as surveyor at Amptill old house, which belonged to the Crown, may have led to this work in Paris. The only other drawing which can be assigned to Thorpe with certainty is a plan drawn in different inks, with title "Sir Walter Coap at Kensington, perfected by me, J. T.," and it is possible that Thorpe made the original design of Holland House, as built in 1606; but even here the phrase "perfected by me" leaves it uncertain what part he actually took in planning the house as a whole. In the Cottonian MSS. (August 1. 1. 75.) there is a survey of Theobald's Park, drawn on vellum and tinted, said to have been made by Thorpe in 1611. The only other references as yet ascertained in regard to this obscure draughtsman are to be found in a MS. note by the late Mr. Wyatt Papworth appended to the Soane Collection. Mr. Papworth found mention of a plan of the Palace of Eltham made by Thorpe in 1590; again in 1609, where he is named as the King's Commissioner for surveying the Duchess of Suffolk's land; and, in 1611, of a warrant for the payment of £52 3s. to Thorpe, for certain repairs to the fencing of Richmond Park, which had been carried away by the flood. Cunningham discovered a reference to Thorpe in Peacham's "Gentleman's Exercise," 1612, wherein he is described as "of the parish of St. Martin's in the Fields" and as "an excellent geometrician and surveior." No other mention of him is known, and the net result of our examination is that he remains an almost unknown man. Indeed, it is not even certain that he was an architect at all. It is probable that most of his authentic drawings were made after the buildings were completed, instead of before, and that they are in the nature of surveys rather than working drawings. The only drawings which can certainly be set down to Thorpe are the ones which he signed or initialled. Besides these, there are the drawings which may probably be his, such as Kirby; and from these it would appear that, if Thorpe was a designer, he adhered to the English tradition of planning, and that he was fairly faithful to the idea of the English gabled house, with its plain sobriety of detail. Assuming him to have been the architect of the older parts of Kirby and Holland House, Thorpe may be taken as a fair instance of the class of men who worked in England, during the transition stage from the builder-designer of mediæval days to the academic

architect of the following century. These men derived their details mainly from pattern-books, but they used them with much adventurousness, and the result was a manner of design of a somewhat informal character, which, though picturesque and lovable in a way, missed the essential quality of architecture—the distinction given by severe restraint and single-minded purpose.

Smithson has already been referred to as the architect of Wollaton in Nottinghamshire. His fame rests chiefly on the inscription in Wollaton Church to “Mr. Robert Smithson, gent., architect and surveyor unto the most worthy house of Wollaton with divers others of great account” (*ob.* 1614). Wollaton in Nottinghamshire was begun in 1580 for Sir Francis Willoughby. Though imposing in mass, Wollaton is not a successful piece of architecture. The front is overloaded with repetitions of the orders, and the great block of the hall which rises above the rest of the front overpowers the façade, and its general topheaviness is emphasized and insisted on by pepper-box turrets at the angles. Smithson’s name occurs in the building accounts of Longleat as “Free master mason” of the works, and there is indeed some resemblance in the use of orders above orders in both houses, which shows at least a common influence. It is probable that Smithson applied to Wollaton the lesson in ornament that he had learnt at Longleat, and by no means improved on the original. The pilaster treatment at Wollaton imitates that at Longleat, but at Wollaton an irrelevant band is introduced about the middle of the pilaster, and the sunk roundels for busts, which are comparatively plain at Longleat, are enriched at Wollaton with some florid cartouches. The designer of Longleat followed Italian models, and Smithson thought to improve on this by the later light of German ornament. But the natural man very soon shows himself in architecture, and the tradition of masonry on which Smithson must have been trained is evident in the outline of the hall block, and in his constant tendency to slip back into Gothic terms of expression, as, for instance, in the tracery of the hall windows.

Huntingdon Smithson, who died November 27th, 1648, and was buried in Bolsover Church, was probably a son of Robert. Huntingdon Smithson designed the “new house” at Bolsover, that is, the existing square castle and courtyard begun in 1613,

and possibly the long gallery block, begun in 1629-30, along the brow of the hill which connects the castle with the riding-school. The riding-school is later, and is evidently by another hand. Bolsover Castle has many points of interest in regard to the development of English architecture. Its details show a singular mixture of Gothic tradition, of classical ideas inspired by German examples, and of the individuality of Huntingdon Smithson himself, who, though evidently of a thoughtful and inquiring turn, was not able to fuse these three into a consistent architectural design. The three elements lie side by side in unassimilated confusion. The pillar room, for instance, has a vaulted stone ceiling, the construction of which is Gothic in principle, and the section of the groining ribs is such as is found in late fifteenth-century work. The pendants, corbels, and capitals to the pillars are of the ordinary pattern-book type, and the disproportion of scale and the combination of heaviness in design, with meagreness and tenuity in detail, are the personal failures of the architect himself. These faults reappear, though in a less degree, in the gallery block. Here, too, there is an evident effort after size, but the effect is only dullness, due to the absence of a fine architectural sense in the designer. The actual construction of the keep is by no means good; a piece of masonry corbelled out next the right-hand corner of the court has given way, and never could have stood for long, a defect in knowledge of building, by no means compensated for by a somewhat extensive acquaintance with German methods of ornament.

The work of both the Smithsons shows knowledge of architectural detail and a good deal of ingenuity. Where they failed was in attempting ambitious architecture, and it is in this regard that they fall so immeasurably below their great successor. The builders of such delightful houses as Littlecote, or Sydenham, or Ragdale old hall, were content with the slightest ornamentation; they adhered to the local tradition of building as handed down from father to son; their buildings entirely answer the purpose for which they were built, and hence they possess a quiet reasonable beauty, due to the well-considered use of materials and the absence of any desire to amaze by technical dexterity. These buildings were the result of the work of many generations of simple-minded men, and as such they bear the impress less of a single personality than of a col-

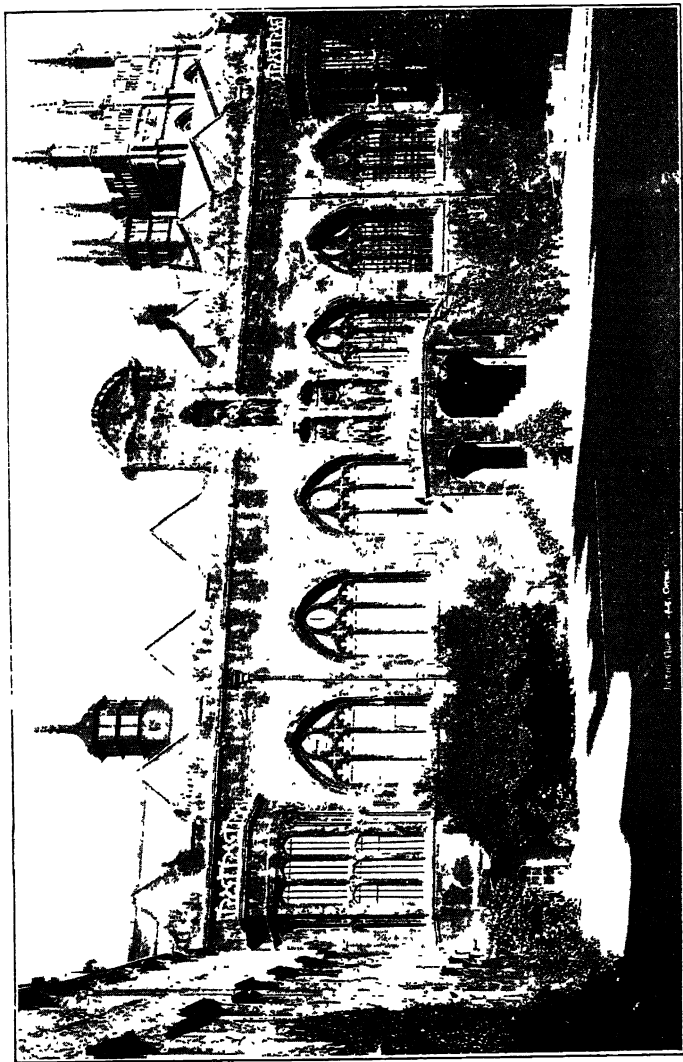

Wilson, Aberdeen, photo.

the design for the latter in 1604, but does not appear to have been employed in carrying it out.

It is probable that Simons supplied the design besides contracting for the work ; and in the case of St. John's, Cambridge, the original drawings, consisting of three "plots" (plans) and three "uprights" (elevations), signed "Raf. Simons" and "Gilbert Wigge," still exist in the college library. The building at St. John's consisted of a court 137 ft. by 165 ft., but it was an unfortunate affair for both of them. Simons lost a hand on the works, and was involved in a lawsuit about the winding up of the accounts, which lawsuit eventually landed Wigge in prison in 1605. Simons appears to have left Cambridge, and is not heard of after this date. Wigge, who was released from prison on petition and humble amends to the college, afterwards built a range of buildings in Walnut Tree Court, at Queen's College, 1616-19. Both men worked in a plain, unambitious manner, with little affectation of Renaissance detail.

The designs of buildings seem to have been supplied indifferently by carpenters, masons, or bricklayers. Simons, Acroyde, who was employed in the schools at Oxford, and Arnold, of Wadham, were masons ; Westley, of Cambridge, who built part of Clare and the new buildings of Emmanuel at Cambridge, in 1634, was a bricklayer ; Holt was a carpenter ; and about the time of Holt's death, a young Herefordshire carpenter was already making his reputation in the west country. The development of building crafts naturally followed the staple building material of the district. Yorkshire was a stone country and consequently abounds in characteristic masonry ; whereas Lancashire, Cheshire, Shropshire, and Herefordshire were at one time thickly wooded, and accordingly developed a half timber style with well-marked peculiarities. John Abel was born in 1597. So far as his buildings can be identified, he worked entirely in half timber, and is said to have designed and built the market-halls of Hereford, Leominster, Kington, Brecon, and Weobley. The market-hall at Weobley was pulled down about fifty years ago and sold as old materials. It is described as having been built in half timber, with a large upper hall carried on wooden pillars, richly carved. The ground floor was open, and it no doubt followed the regular treatment of west country market-halls. The building stood at the head of the triangular square in the centre of the village, but not a

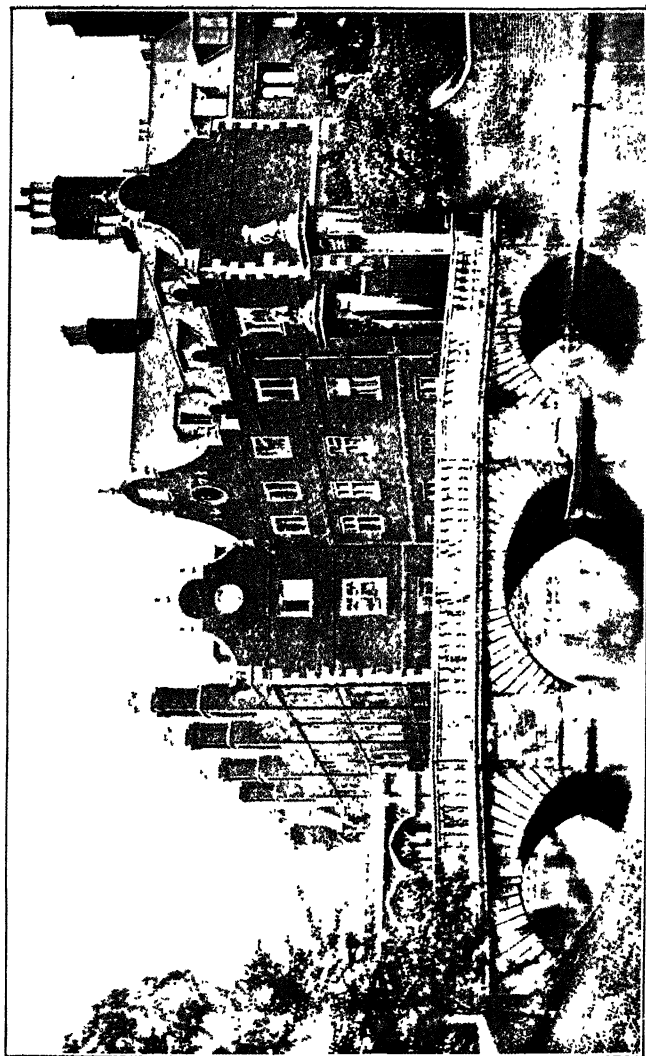

Frith & Co. photo.

vestige of it remains except the weather-cock on the turned oak baluster, which was transferred to the half timber house close by. The wooden porch at Weobley, which closely resembles the detail at Abbey Dore, was probably by Abel. The Shire Hall at Hereford was destroyed about forty years ago. Duncombe, writing in 1804, says: "The old Shire Hall of Hereford was constructed mainly of wood, and rests on three ranges of pillars, having nine pillars in each range; the length is 84 feet, the breadth 34; at present it consists of one floor only. . . . In its original state there was a second floor divided into apartments for the accommodation of the fourteen trading companies of the city. . . . The Shire Hall was built in the latter part of the reign of James I. by John Abel." After the second floor was taken down, the first floor was covered in with a three-gabled roof, and it is so shown in old drawings. There are now no remains of it whatever. The old hall at Leominster has fared rather better. It was built in 1633, and was pulled down in the present century, but rebuilt as "The Grange," and is now inhabited as a private house. Unfortunately, the intercolumniations on the ground floor have been filled in with windows, which make it impossible to form any adequate opinion of the value of the original design. The details are not without a certain ingenious fancy, but they are coarse in execution and show a merely rudimentary acquaintance with the models they professed to imitate.

In 1634 John, Viscount Scudamore, having some misgivings as to his right to the tithes of his estate, and acting under the influence of Laud, obtained a special licence to restore the Church of Abbey Dore, and employed Abel to carry out the work. No architect appears in the transaction at all. Scudamore supplied the wood, Abel the design and labour. About £1,000 (money of the time) was spent on the work, which included a new roof with oak rafters and brackets, a new gallery, seats, reading desk, and pulpit, some painted glass, and the great oak screen under the chancel arch. The latter is in five bays, divided by columns with rough Ionic capitals, carrying a frieze with a curious Latin inscription, "Vive Deo gratus, toti mundo tumulatus, crimine mundatus, semper transire paratus." This inscription also occurs at Leominster. Above the frieze are the royal arms, with two small coats-of-arms on either side, set in open strapwork and divided by pierced obelisks. The

general design of the screen is bold and effective, and the scale is well preserved throughout, but the workmanship is exceedingly rough. The marks of the axe and the chisel are everywhere apparent; even the carpenters' numbers scratched on the different pieces of wood were never removed, and the columns

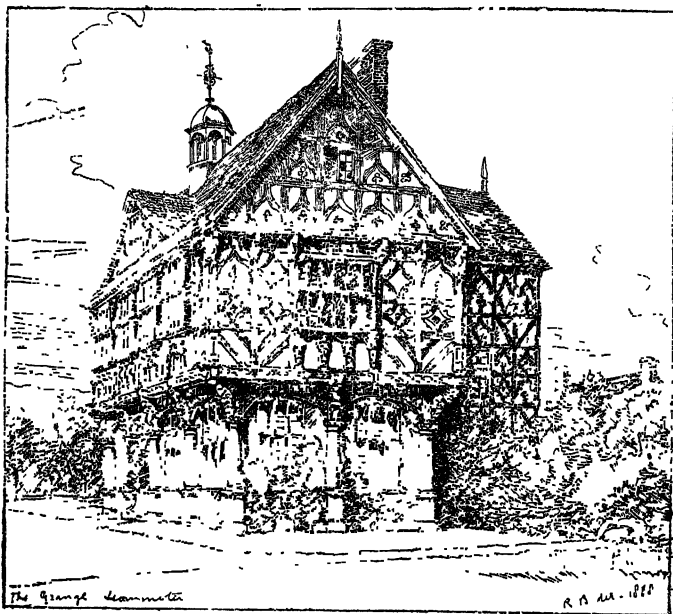

THE GRANGE, LEOMINSTER.

and pedestals are made out of one solid baulk of oak from top to bottom.

Abel died in 1694, at the age of ninety-seven, and was buried at Sarnesfield in Herefordshire. His work is interesting as showing the result of the new movement in out-of-the-way districts. Abel, it is clear, had received no training in architectural design. The details of his work abound in blunders, and his acquaintance with Renaissance detail appears to have been entirely at second-hand, and derived from those insidious

pattern-books to which I have already referred. These books never gave working drawings of details, and very seldom any scale. The country carpenter was therefore left to his own devices, and the results of his mother wit and the models given in his pattern-books were something altogether astonishing. On the other hand, the actual construction is good, the immediate result of local tradition. It is honest and straightforward, and essentially wood construction, not a construction borrowed from stone or metal. We thus have the two streams

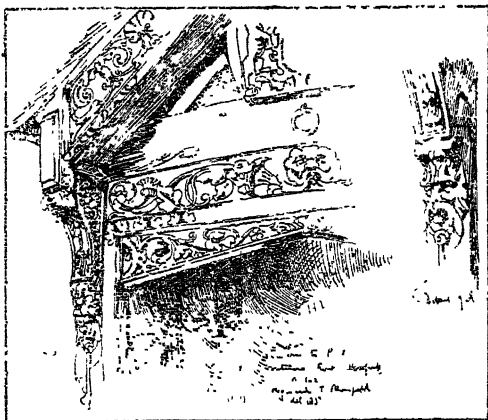

CARVING: BUTCHER'S ROW, HEREFORD.

meeting, that of the building tradition of the countryside, and that of the new fashion of ornamentation, filtered through hardly intelligible pattern-books; the two run side by side at present, not yet fused into a reasonable method of design. So far, what is good in this Herefordshire carpenter's architecture was the result of the older Gothic tradition. What is bad, and the ornament as a rule is wholly bad, was the result of fashion ill-understood. It by no means follows, however, that anything more could have come of the old tradition by itself. The building art had in fact arrived at an *impasse*. The vigour and vitality that had expressed itself in Gothic architecture was by no means extinct, but other elements had come into play, and

new ideas were beginning to take their place in consciousness. The language, the architectural idioms which had been adequate

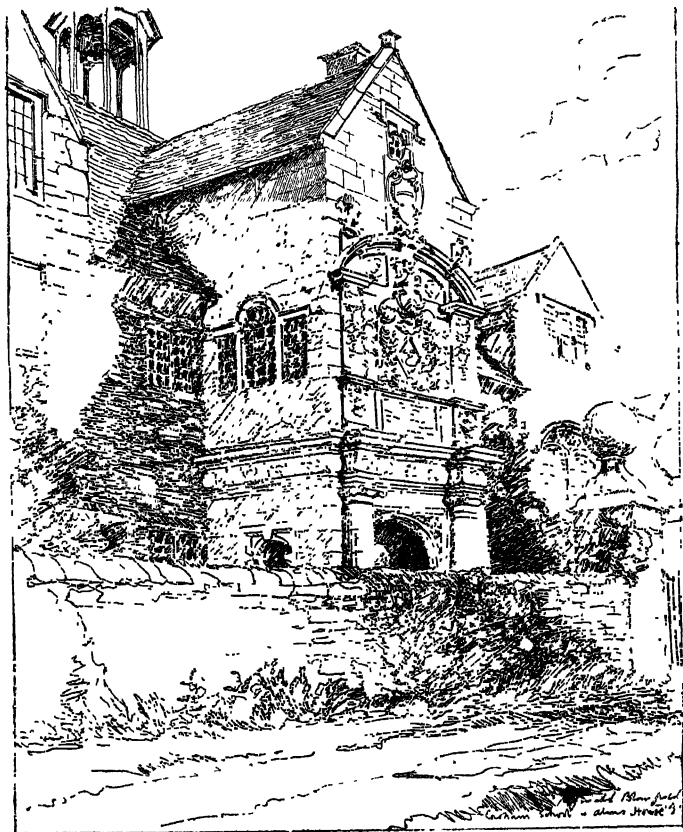

SCHOOL AND ALMSHOUSE, CORSHAM.

for the ideals of the mediæval builder missed their mark as the expression of the more subtle intention of the Renaissance. Gothic architecture, as a language, was indeed dead, but the

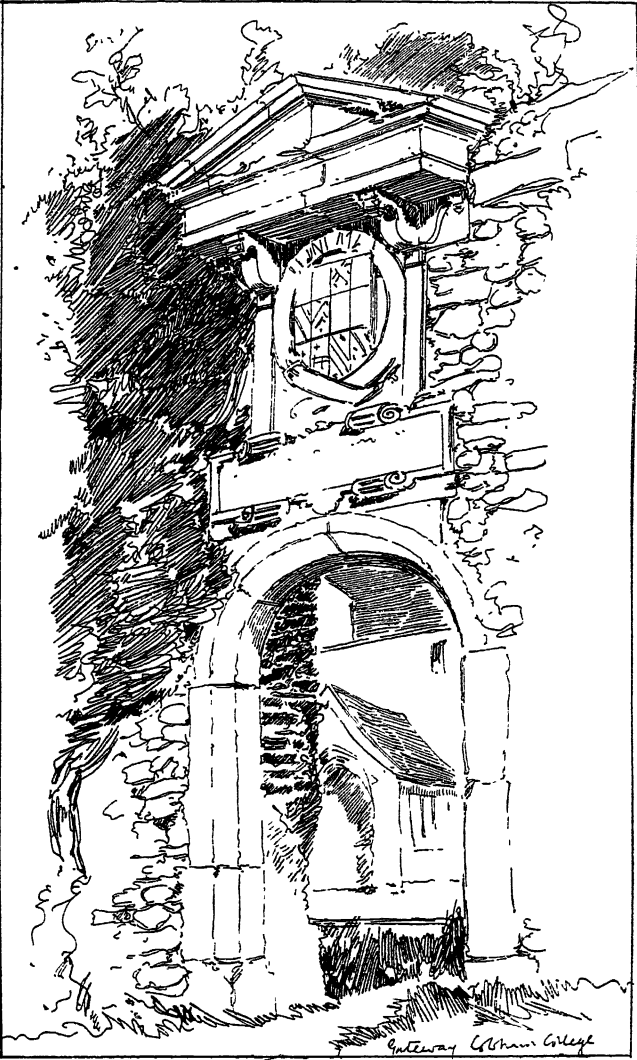

GATEWAY AT COBHAM COLLEGE.

artistic spirit which had once expressed itself in mediæval architecture, and inspired its craftsmanship, was as active as ever, only it was finding its course in new channels, and seeking fresh methods of expression for its widening thought. This motive power, this creative and informing spirit, was neither Gothic nor Renaissance, but simply the instinct of the nation and the race, and as such we shall find it reasserting itself with a vigour as characteristic, as entirely national, as any that it had ever displayed in mediæval times. Within a hundred years from the date of the screen of Abbey Dore we shall find the tradition of sound and skilful handiwork re-established in England, and country workmen capable of executing woodwork, masonry, and brickwork of delicate refinement and unsurpassable workmanship; we shall find in work of the seventeenth and eighteenth centuries the independence of thought, the sober taste and kindliness of manner which has throughout stamped our architecture, whether mediæval or Renaissance, with a character unmistakably English.

CHAPTER IV

SIXTEENTH CENTURY HOUSE PLANNING

ABEL was not the last of the builder-designers, or master builders, as they might fairly be called. John Westley and Thomas and Robert Grumbold carried on the tradition at Cambridge throughout the seventeenth century, but meanwhile a race of architects had sprung up, perhaps of less practical knowledge of building materials, but of wider scholarship and greater attainment as designers; and before discussing these forerunners of the modern architect, with his complete professional equipment, it will be desirable to consider the state of English architecture before this new era was started by Inigo Jones.

Throughout the sixteenth century a steady advance was made in the development of house planning. Few important churches were built in that century, and no attempt was made to depart from the traditional methods in this regard; but the whole ingenuity of the builders of the sixteenth century seems to have been concentrated on the house. Owing to the decay of feudal power, the necessity for strongly fortified houses had ceased to exist by the beginning of the sixteenth century, and we find two main types of house in common use. On the one hand, for larger houses, there was the house built round one or more courts, and on the other, what we may, for convenience, call the yeoman's house, consisting of a hall in the centre, with kitchen and offices at one end and a solar and living rooms at the other. This second and smaller type of house was the direct survival of the smaller mediæval dwelling-house. It was altered and adapted in many ways, but throughout the sixteenth century it continued to be the typical form for small and moderate-sized houses, and can easily be traced in their various modifications. From these two sources the characteristic features of the Elizabethan house were developed by a double process, that is to say,

the plans of the larger houses resulted from the gradual modifications of the earlier house with inclosed courts, and the plans of the smaller houses from the natural extension of what has been called above the yeoman's house.

Of the courtyard house, which speedily developed into the simple quadrangular house, the earlier part of Haddon Hall, or South Wingfield Manor House, built in the reign of Henry VI. by Ralph, Lord Cromwell, are good examples. These houses must be taken as the immediate precursors of the Tudor house in historical development. They were built with a view to defence, yet with some regard to comfort of living. Instead of the grim, impassable keep, there were courtyards, with solid walls, it is true, on the outer side, but with sufficient space within the court to admit of some reasonable amount of light and air to the rooms of the surrounding buildings. The necessity of a symmetrical court was as yet unthought of. The inclosing buildings followed the conditions of the site, with the result that the court was seldom exactly rectangular; and as the idea of defence was still urgent enough to induce the builder to place his house on a rock, differences of level and all kinds of irregular angles were accepted with indifference. But under the long "King's Peace" of Henry VIII. this necessity of treating the house as a fortress disappeared, and when houses were placed on level sites and on low-lying ground, there was no occasion for any awkward angles, and the rectangular court was adopted as a matter of course. Layer Marney and Sutton Place (1521-27) are good early instances of the quadrangular arrangement.¹ Generally speaking, the quadrangular house of the early part of the sixteenth century consisted of an inclosed court with an entrance under a tall gatehouse, rising higher than the adjacent buildings, as at Hampton Court and Nonesuch. To one side, or on the side opposite the gatehouse, were the hall and offices, with living and sleeping rooms round the remaining sides, which rooms, except when arranged *en suite*, could only be entered from the court.

Out of this quadrangular plan speedily grew the various types of the larger Elizabethan house. In these houses the quadran-

¹ The court at Sutton was originally quadrangular, measuring internally 81 ft. 3 in. by 81 ft. 3 in. It was entered by a gateway on the north side under a tower flanked by hexagonal turrets. This tower is said by Mr. Harrison ("Annals of an old Manor House," Macmillan, 1893) to have been about 70 ft. high. It was standing in 1750, but has since been destroyed.

gular plan with one or more courts was adhered to through the sixteenth century, as at Kirby, Burghley, and Audley End, and

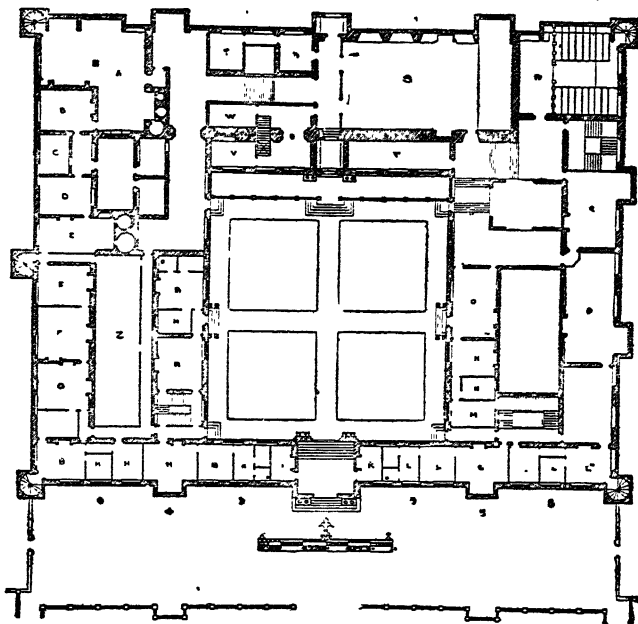

BUCKHURST HOUSE, SUSSEX. (SOANE COLLECTION.)

- | | | |
|----------------------------------|--|--|
| A. Kytchen. | O. His ante camera. | W. Butlers lodging. |
| B. Dry larder above, wett under. | P. Parlour, great chamber over. | X. Pantry. |
| C. Scullery. | Q. Wayters chamber. | Y. Pantlers lodging. |
| D. Bolting. | R. This chapell is below. | Z. A tennis court 65 fo. long. |
| E. Bakehouse. | [Note.—The part figured R is probably the gallery, the chapel floor for the servants being below.] | 1 1. The garden and orchard syde. |
| F F. Lodgings heare. | S. Hall. | 2. Woodyard heare, bake house, brewhouse, etc. |
| G. Offices. | T. Wine cellar underneath, terrace above throughout. | 3 3 3. The gallery over these lodgings. |
| H H H. A noblemans lodging. | U. Buttry. | 4. For my ladys syde. |
| H H H. A noblemans lodging. | V. Breakfast-room. | 5. For my lords syde. |
| H H H. A noblemans lodging. | | 6. Terrace heare. |
| I. Porters. | | 7. Garden house. |
| K. Lodg. | | |
| L L L. A noblemans lodging. | | |
| L L L. A noblemans lodging. | | |
| M. Servants lodging. | | |
| N N. A noblemans lodging | | |

the plan of Buckhurst in Kent (since destroyed), which is preserved in the Soane-Museum, is a characteristic example of the

arrangements of a great nobleman's house in the middle of the sixteenth century. For smaller houses a quadrangular plan was sometimes employed, with a small court in the centre merely for purposes of light and air, and in no way as a means of architectural effect. Instances of this are found at Chequers' Court, near Tring, Burton Agnes and Barlborough in Yorkshire, and Chastleton in Oxfordshire.

The tendency, however, was to break away from the quadrangular plan inclosed on all four sides. When Dr. Caius built his New Court at Caius College, Cambridge, in 1565, he expressly forbade the closing in of the court on the south side, "lest the air from being confined within a narrow space should become foul"; and it was probably on this ground that the plan of a three-sided court came into general use. This meant the removal of the gatehouse side with its tall tower. The entrance to the house was set back, either as a projecting bay in the centre of the main façade which gives the familiar E-shaped plan, or towards one end of it, with a corresponding bay at the opposite end, and was usually carried up the full height of the building. The side left open was treated in various ways. At Rushton a corridor of one storey was built between the two wings; elsewhere the front was fenced in with a simple balustrade of stone, as at Charlton House in Wiltshire, before the alteration of 1779, or the side walls of the wings were extended and returned opposite the house to inclose a forecourt with a gatehouse, in one or more storeys, in the centre, opposite the main entrance. As part of this change, the gatehouse had now detached itself from the house, and had become a separate building of more or less importance. The most famous instances are the gatehouses of Tixall in Staffordshire (1580), a three-storey building of stone, with four octagonal turrets at the angles, and a remarkably correct design of the orders above the entrance archway; Burton Agnes in Yorkshire (1610), a three-storey building of brick and stone, with two octagonal turrets at the sides; Lanhydrock in Cornwall (1651); Charlecote, Cranborne in Dorsetshire, and the remarkable instances of Westwood in Worcestershire, and Stanway in Gloucestershire.

Thus, by the removal of one side of the court, the rearrangement of the porch in the centre of the arm connecting the two side wings, and the shortening of the side wings, all of which resulted from the transformation of the quadrangle into a three-

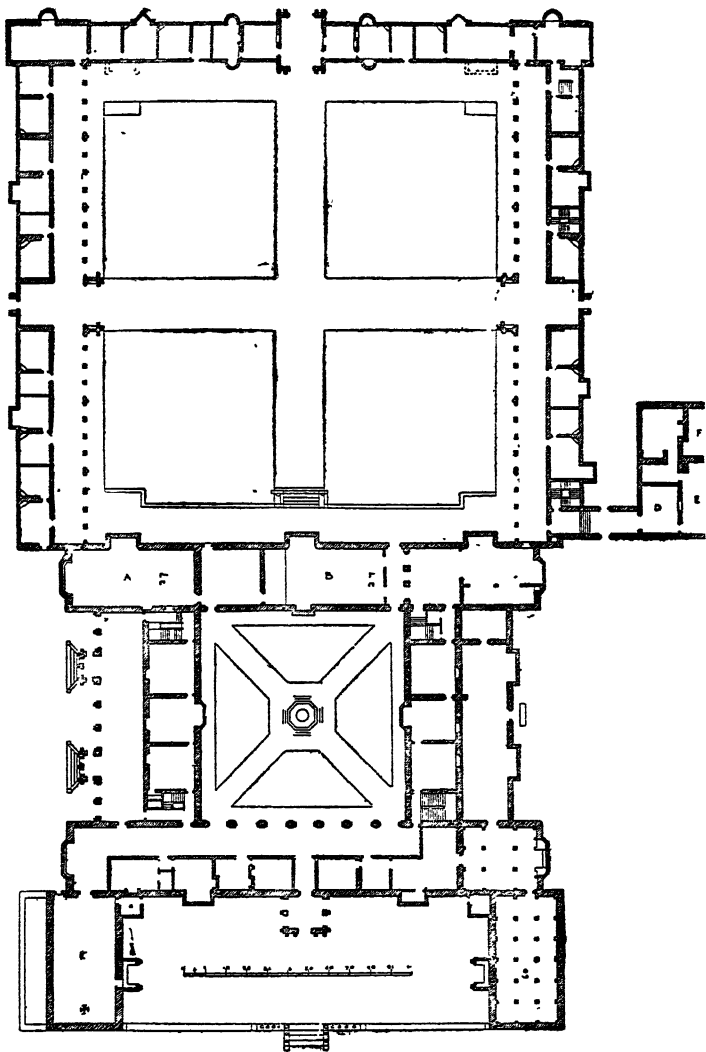

AUDLEY END, ESSEX. (SOANE COLLECTION.)

A. Parlour.
B. Hall.

C. Chapel.
D. Surveyry.

E. Kitchen.
F. Dry larder.

sided court, open in front, we arrive at the E-shaped plan, frequently found in large Elizabethan houses, as, for instance, North Myms in Hertfordshire (early seventeenth century), and Corsham Court, near Bath. That the E-shaped plan had nothing at all to do with any fanciful compliment to Elizabeth is proved by houses built on this plan before she came to the throne, or was even within sight of it, such, for instance, as

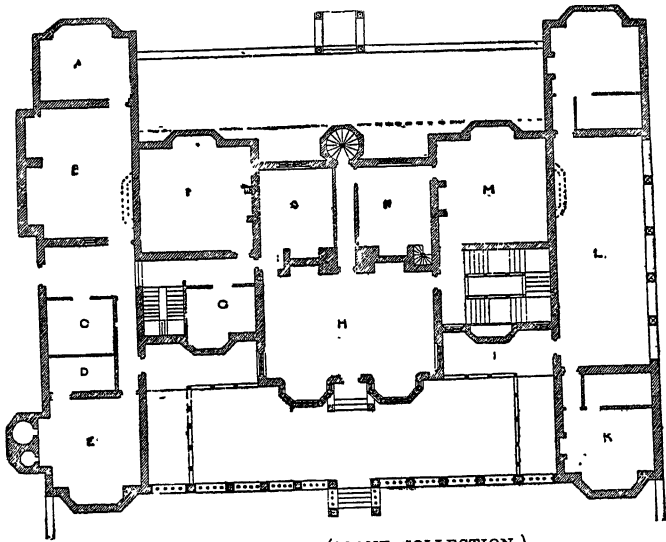

HOLLAND HOUSE. (SOANE COLLECTION.)

- | | | |
|-------------------|-----------------------------|------------------------|
| A. Wet larder. | F. Winter parlour. | L. Terrace and gallery |
| B. Kitchen. | G. Pantry. | above. |
| C. Dry larder. | H. Hall—great chamber over. | M. Parlour. |
| D. Bolting house. | I. Walk: terrace above. | N. " |
| E. Pastry. | K. Lodge. | O. Bedroom. |

Barrington, built by Sir Thomas Phelips, probably the man who was appointed by Henry VIII., in 1539, chief supervisor of the buildings in the town and marches of Calais. By extending the side wings to the back as well as the front, another common form of sixteenth-century plan was obtained, the H plan, as at Shaw House, near Newbury, 1581, and the plan of Holland House given in the text.

All the plans that we have considered so far belong to the class of the larger Elizabethan house, and are, in my opinion, directly descended from the larger fortified houses with internal courts of the Middle Ages. The court was extended and made symmetrical, and finally one of the inclosing sides was abandoned in order to gain increased light and air. At this stage of development their characteristic is their complete and deliberate symmetry. Gable answers to gable, even chimney-stack to chimney-stack; and this quality, and their more intricate planning and greater scale, seem to me to differentiate them from houses which might also be classified as belonging to the E plan, but which, probably, have arrived at the result in another way, such

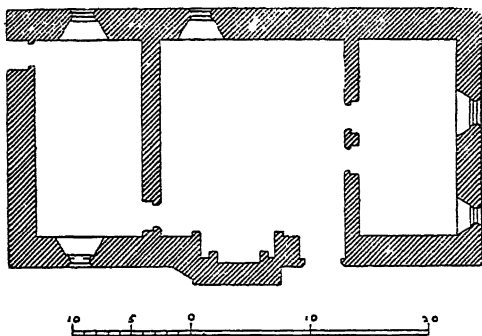

PLAN OF THE FISHING HOUSE AT MEARE.

as the manor-houses of Lancashire and Cheshire, and buildings in which, though the general plan is symmetrical, or nearly so, there is no obvious and deliberate attempt at symmetry in detail. The plan of these houses seems to be identical with the small unfortified mediæval dwelling-house, consisting of a common hall in the centre, with offices and one or two small rooms ranged at either end, or at one end only. Instances exist in the original part of Cranborne, the priest's house at Muchelney, the fishing house at Meare in Somersetshire, and in the ordinary plan of the half-timbered yeoman's house in the Weald of Kent, such as Beavor House, or Singleton, near Ashford. This plan, being in fact about the simplest arrangement of rooms and offices possible, was derived from remote

antiquity, and survived with extraordinary pertinacity in England. It appears again and again under varying forms. The plan of Fountains Hall, for instance, in Yorkshire (1611), consists of a hall, dividing the two sets of apartments at either end, with two separate staircases thrown out at the back. Except for the position of the staircases, the general outline of this plan, on the first floor, very nearly resembles the ordinary plan of a small fifteenth-century house, and there can be little doubt that the smaller E- and H-shaped houses of the sixteenth century were merely modifications of this traditional plan, whereas in the case of the larger Elizabethan houses a similar result was arrived at by a modification of the old inclosed courtyard.

This opening-up of the house, the importance attached to the admission of light and air, were not the only advances in planning made in the sixteenth century. In the earlier houses built on a courtyard plan the builders appear to have been content if they got separate access to each room on the ground floor, directly from the courtyard, and on the upper floor either by doors from room to room or by long galleries running all round the court, and usually open on the courtyard side. The last survivals of this method were to be found in the old inns, such as the "White Hart," the "George," and the "Queen's Head" in Southwark, and in many an old coaching inn. This manner of building was, however, found to be intolerable, and the next step forward was to provide corridors and passages for purposes of communication between the different rooms without going in and out of the house. In order to reach the upper rooms, staircases were provided in every part of the building, much on the system that may still be seen in the seventeenth-century college buildings at Oxford and Cambridge. The difficulty, however, was never fairly met in the sixteenth century. People were content, apparently, to pass from room to room, with such additional assistance as might be gained from an occasional narrow passage or newel staircase. It was not till Inigo Jones introduced an entirely new system of house design that the problem was squarely met and the lines laid down on which modern house planning has proceeded more or less steadily ever since.

Inconvenient, however, as some of these plans appear to be, the ingenuity displayed is sometimes very great, more especially in the less common examples and those eccentricities of plan-

ning which were probably either experimental or due to some caprice on the part of the owner. Besides the quadrangular, the E- and the H-shaped plans, there are occasionally found houses planned as a solid square, such as Barlborough (1583-84) and Bolsover (1613). Barlborough Hall in Derbyshire was built by Francis Rodes in 1583-84. Considering the date, the plan is very remarkable. The kitchen and offices were placed on the ground floor, and the hall and principal living rooms on the floor above; a small staircase led up from the kitchen, but

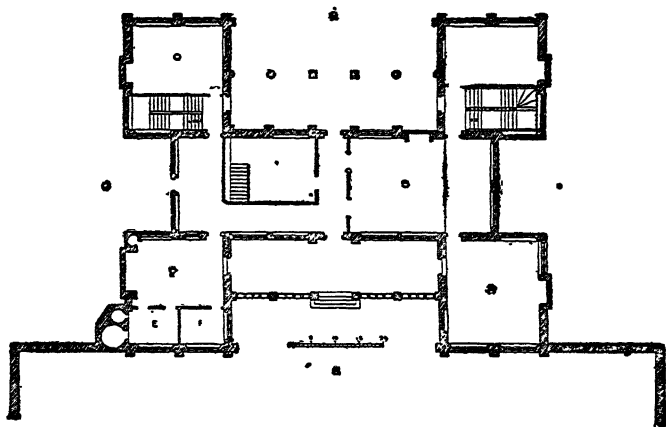

UNNAMED PLAN IN THE SOANE COLLECTION.

- | | | |
|--------------------|--------------|-------------|
| A. Dining parlour. | E. Pastry. | H. Garden. |
| B. Hall. | F. Larder. | I. Orchard. |
| C. Winter parlour. | G. Woodyard. | K. Court. |
| D. Kitchen. | | |

the chief entrance to the principal floor was reached by a long external flight of stairs. In the centre of the house was a small court, or rather well, for purposes of light and air, measuring about 26 ft. by 22 ft.¹ The noticeable point in this plan is that the architect has simply turned his back on the traditional arrangement of the hall as a common living room, dividing the offices from the rooms of the family. The hall here is planned specifically as an entrance hall, and nothing more, with the

¹ This has since been covered in and converted into the principal staircase.

great dining chamber beyond it, the latter having separate access from the hall and from the stairs from the kitchen. The



GARDEN HOUSE AT AMESBURY.

plan has a singularly modern feeling, and though it can be traced to the courtyard type, the court here is little more than a well, and we get an approximation to the next advance in

planning, when architects grasped the idea of combining under one roof two or more sets of rooms, with a corridor between.

There is no doubt that the house builders of the latter part of the sixteenth century were quite as fond of experiments in planning as they were of unholy combinations of the orders. The symbolical plans of Longford Castle and the triangular lodge at Rushton Hall are instances in point. Both plans seem to have been intended as an exposition in stone of the doctrine of the Trinity. A key plan is attached to the plan of Longford Castle in the Soane Collection, which is almost exactly similar to a diagram given in Sir John Peshall's edition of Wood's "Athenæ," 1773, as then existing in one of the windows of St. Peter's Church, Oxford. This diagram has words running to the various points, which concisely state the doctrine of the Trinity. The resemblance to the plan is singular, and whether the key plan attached to the drawing in the Soane Collection is merely an ingenious after-thought of some seventeenth-century mystic, or actually represents the intention of the original designer, it would have been quite in accordance with

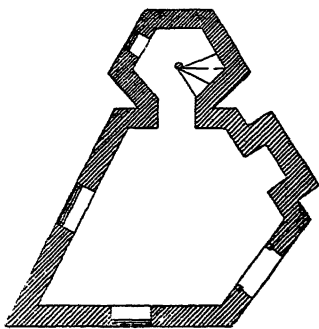

PLAN OF GARDEN HOUSE AT
AMESBURY.

certain phases of thought in the early part of the seventeenth century to make a house or a building symbolical of some recondite idea. There can be no doubt that such was the intention of Sir Thomas Tresham when he built the triangular lodge at Rushton. The curious garden house at Amesbury, designed on a system of pentagons, is another instance. In Northamptonshire there are examples of buildings planned as a cross, such as Gayton Manor House and Lyveden new building; but these, and other vagaries of planning, have mainly an archæological interest, and had little or no influence on the development of English house planning.

By the end of the sixteenth century the idea of the hall as a

common living room was going out of fashion. It was used for Christmas revels and great entertainments, but the master and mistress had their private dining-room, and even as early as 1460 a "privy-parlour" was attached to the hall at Wanswell Court in Gloucestershire. Moreover, the long galleries, characteristic of the Elizabethan house, tended to diminish the importance of the hall, and the latter gradually came to be used rather as a means of communication between the different parts

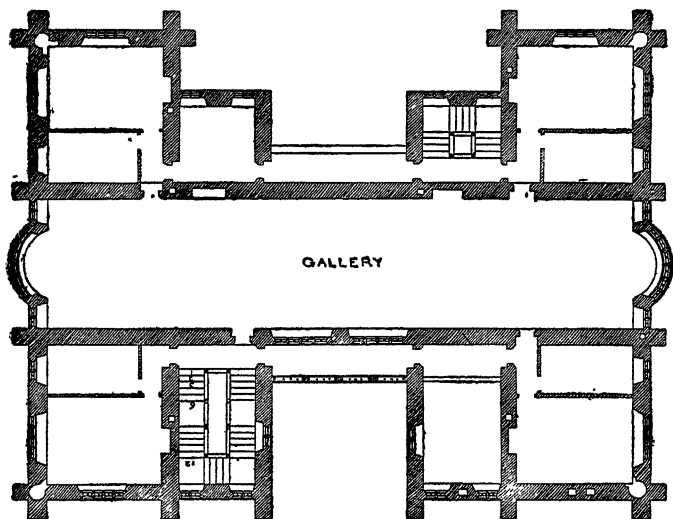

THORNTON COLLEGE, SIR VINCENT SKYNNER'S. SECOND STOREY.
(SOANE COLLECTION.)

of the house than as a place in which the household lived. What the hall lost in importance the grand staircase gained. The fact that the gallery and the chief living rooms of the house were on the upper floors suggested that the staircase should become one of the most important features of the house, and the fancy of the Elizabethan nobleman indulged itself here in a profusion of carving, mouldings, balusters, and plaster work, which remain as monumental evidence of their exuberant taste in ornament.

The long gallery, the great staircase, and a superabundance of windows were the main contributions of the sixteenth century to domestic architecture. The gallery was placed on the upper floor and usually ran the whole length of the house or of one side of the court. Probably the earliest instance was the gallery at Hampton Court. This was begun by Wolsey, and was completed in 1536. It was destroyed by Wren in 1689. It measured 180 ft. long by 25 ft. broad, and had a large semi-circular bay in the centre. Mario Savorgnano, a Venetian who visited England about the date of this building, was struck by these galleries, "which are long porticoes or halls, without chambers, with windows on each side, looking on gardens or rivers, the ceilings being marvellously wrought in stone with gold, and the wainscot of carved wood representing a thousand beautiful figures." No galleries of this date with stone roofs exist, and the writer must have mistaken plaster for stone. Later in the century galleries were nearly always provided, even in moderate-sized houses. The gallery at Audley End (destroyed in the last century), which John Evelyn pronounced to be "most cheerful, and one of the best in England," measured 226 ft. long by 32 ft. wide and 24 ft. high. The gallery at Montacute is 170 ft. long by 20 ft. 6 in. wide, and runs the whole length of the building, with semicircular oriels at each end. The gallery at Hardwick (1590-97) measures 166 ft. long, 22 ft. 5 in. wide, and 26 ft. high; that at Parham in Sussex, 160 ft. by 18 ft. by 13 ft. high the gallery at Bolsover (1629) was 220 ft. long; and the plan of the old Royal House at Ampthill, in the Soane Collection, shows a gallery 243 ft. long and 26 ft. wide. Of smaller galleries, that at Charlton in Wiltshire measures about 130 ft. by 22 ft.; and the gallery at Haddon Hall, 109 ft. by 18 ft. wide. The gallery of Queen's College, Cambridge (1537-41), measures 80 ft. long by 12 ft. broad by 9 ft. high; that of St. John's, Cambridge, is now 93 ft. long, but was originally 148 ft., with an oriel at one end. The gallery of Astley Hall, near Chorley in Lancashire, measures 72 ft. by 12 ft. 6 in. by 9 ft. high; that of Moreton Hall (1559) 75 ft. by 12 ft. 6 in. Oriel windows were commonly placed at the ends, and two or more bays at the sides, carried up from the ground floor; where the gallery was open on both sides, the bays, as a rule, were not set opposite each other. The sides were wainscoted, and the ceilings, whether flat, or coved,

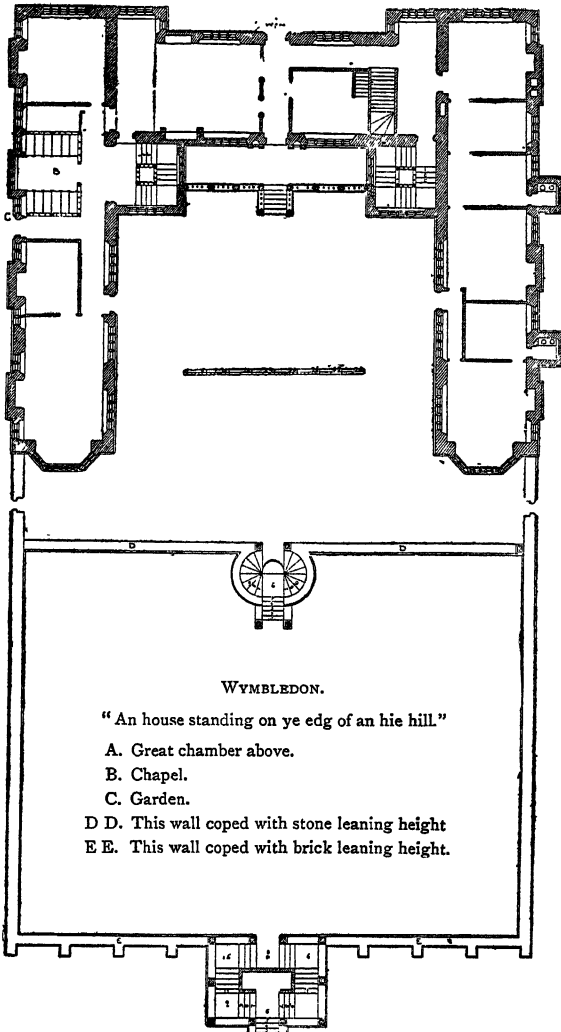

WYMBLEDON. (SOANE COLLECTION.)

or segmental, were usually enriched with elaborate plaster work.

At Old Wimbledon House, built by Sir Thomas Cecil in 1588, and destroyed by the Duchess of Marlborough, there were two galleries, which are described in the survey of the Commissioners of 1649. One was of stone, 108 ft. long, "seeled over head (with parge work), pillored and arched with gray marble, waynscotted round with oak, varnished with green and spotted with stars of gold." The great gallery on the second floor was 109 ft. 8 in. long and 21 ft. 1 in. wide, "floored with cedar boards, casting a pleasant smell, seeled and bordered with fret work well wrought, very well lighted, and waynscotted round with well-wrought oak, 13 ft. 6 in. high, garnished with fillets of gould on the pillars, and stars and cross-patches on the panes, in the middle whereof is a very fayre and large chimney piece of black and white marble, engraved with coates of arms, adorned with several curious and well gilded statues of alabaster, with a foot pace of black and white marble."

The galleries and principal rooms in the greater houses were profusely decorated with colour. Wallop, writing to Henry VIII., November 17th, 1540, mentions that Francis I. had told him that he "heard saye that your majestie did use much gilding in your said houses, and especially in the rooffs, and that he in his building used little or none," preferring the natural colours of wood, such as ebony, brasel wood, etc., as "more rich than gilding, and more durable." "The antike work," that is, modelled ornament, at Hampton Court, was covered with gold and byse (light blue). The ceiling of the hall at Theobalds was decorated with the signs of the zodiac, and by means of some ingenious mechanism the sun performed its course across the ceiling, and the stars came out at night. Another hall at Theobalds was painted with designs of the towns, mountains, and rivers of England; and most of the ceilings were painted blue, with gilt roses. At Boughton Malherbe in Kent (1573) there were, till recently, considerable remains of red, blue, and yellow colour on the plaster work, and heraldic bearings were emblazoned to the full wherever used. Perhaps the most remarkable example of coloured and modelled plaster work in England is the exceedingly beautiful frieze in the state room at Hardwick Hall. The taste, however,

for colour decoration, as opposed to painters' painting, seems to have lost ground in the first half of the seventeenth century. The plaster work of about that date, as used by Inigo Jones, was not as a rule coloured at all. Instead of modelled and

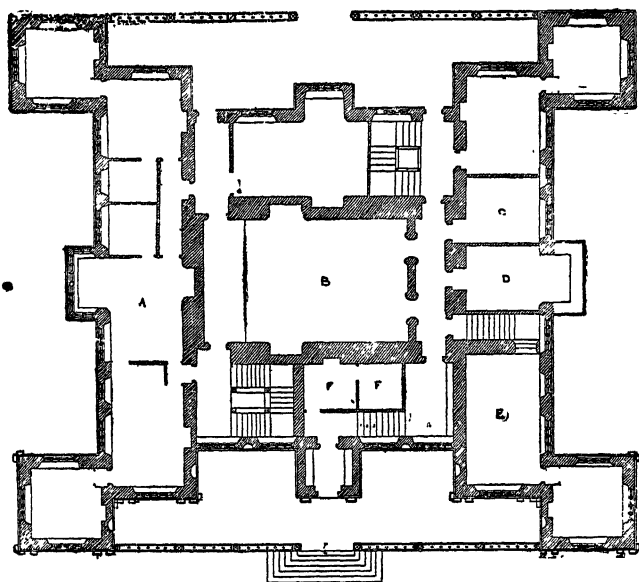

WOLLATON HALL. (SOANE COLLECTION.)

- | | |
|--|------------------------------|
| A. Gallery above 100 feet. | E Kitchen under the servery. |
| B. Hall—35 feet to the sills of the windows. | F F Porter's lodgings. |
| C. Pantry. | G. Orchard heaves. |
| D. Buttery. | H. Garden heaves. |

coloured plaster, large panels of painted allegorical figures became the accepted method of decorating interiors; and it is a fact which throws a suggestive sidelight on the brotherhood of the arts, that in proportion as the painters advance, the other arts have to quit the field. The taste was lost for that



STAIRCASE, WYE COLLEGE, KENT.

exquisite craftsmanship which made the rooms of Henry VIII.'s palaces the admiration even of the fastidious Venetian; and with it disappeared that fine sense of decoration which was satisfied with the harmonies of the tapestries of Hardwick, and with the quiet play of light and colour over the soft modelled surface of its plaster work. The magnificent audacity of Rubens's brushwork seems to have bewitched the taste of the Court. It was forgotten that each art has its limits, and not yet realized that the instinct of the painter, in so far as it is simply graphic, is the most insidious enemy of architecture.

The great staircase, with its carved oak newels, is a familiar feature of sixteenth and early seventeenth century domestic work. The abandonment of the stone staircase in favour of wooden stairs of twice the width, easier ascent, and adequate light shows the higher standard of comfort which accompanied the growing wealth of England. Stone ceased to be used as the inevitable material for staircases, and wooden stairs of solid and elaborate construction were built in most new houses, and were often added to old ones. The position of the staircase varied. It was usually in close proximity to the hall, but the use of the hall as a living room was still sufficiently important to keep the staircase distinct from the hall. At Littlecote the main staircase is to the right of the hall as you enter, and separated from it by the entrance passage. At Canons Ashby the staircase is to the right-hand further corner of the hall; but it was more commonly placed to the left of the hall as you entered, as at Aston Hall, Hatfield, and Sydenham. At Fountains Hall there are two staircases, placed in square projecting bays at the back of the hall; and at Godinton in Kent the staircase is placed in a square bay at the back, and separated from the hall by an open wooden screen. Blickling is a somewhat unusual example: the hall and staircase are placed in the central range that divides the two courts from each other, and instead of being detached from the hall a broad flight of stairs leads directly out of it to the half landing, and thence by returning flights on either hand bringing up on the first floor landing. Of the treatment of the stairs in detail there were two main variations. First, the staircase built in a quadrangular compartment, with a well of considerable size in the centre, and detached newels, as at Aston Hall (1618-35) and Hatfield (1607-11); secondly, the staircase built in

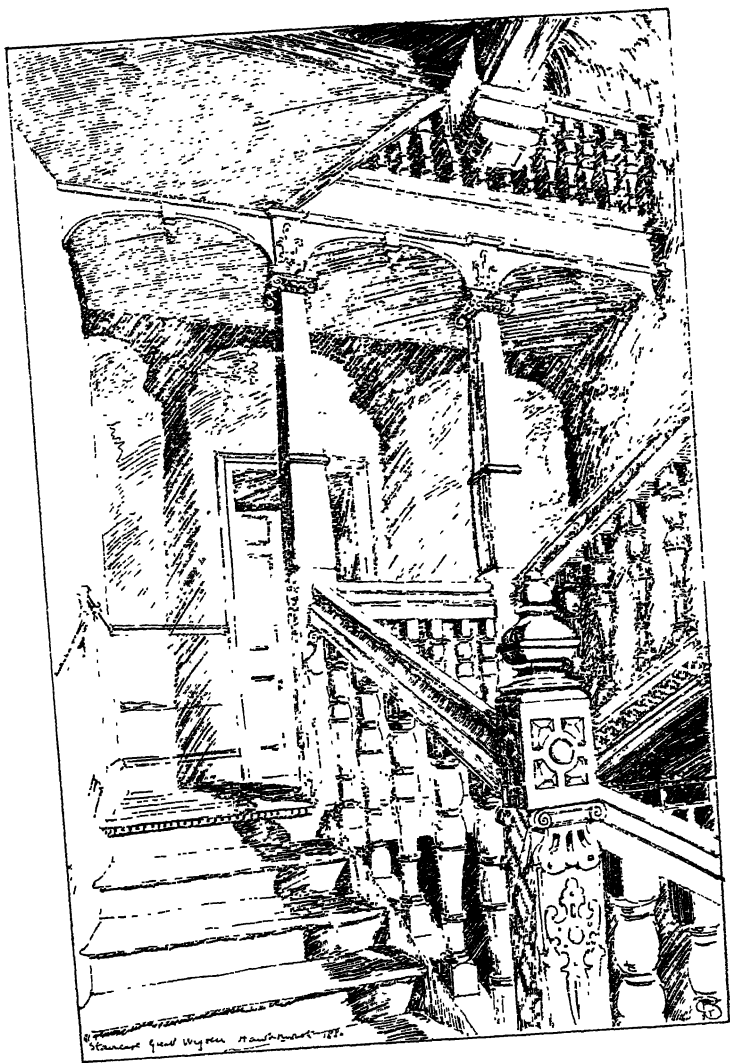

STAIRCASE, HAWKHURST, KENT.

narrow oblong spaces, with either single newels, or newels coupled together with wooden arches or brackets, as at Burton

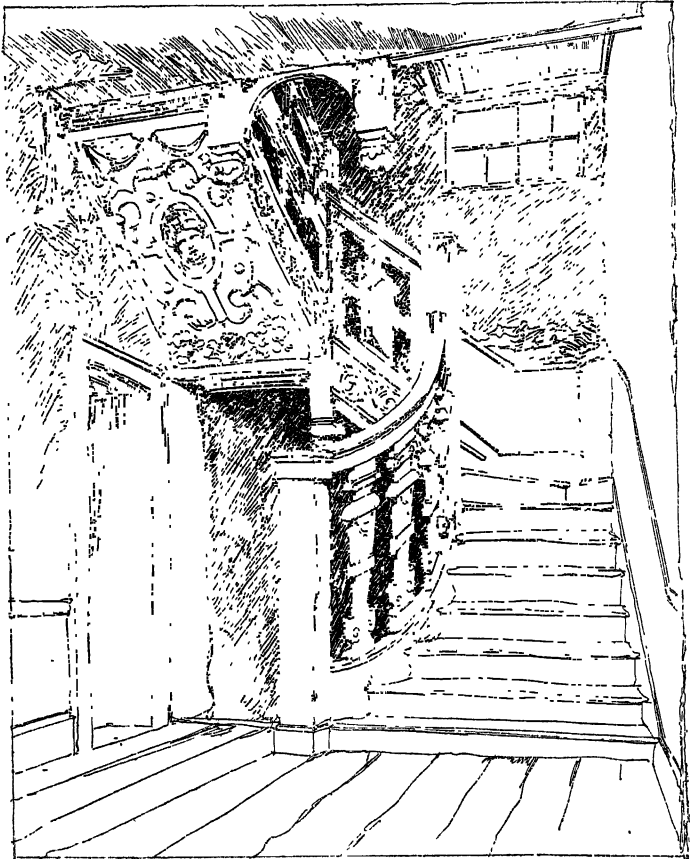

STAIRCASE, FORMERLY IN WHITECROSS STREET.

Agnes (1602-10), Audley End, Cranborne, and the single newel staircase of Sydenham. The newels and strings were elaborately carved, and small figures instead of terminals were

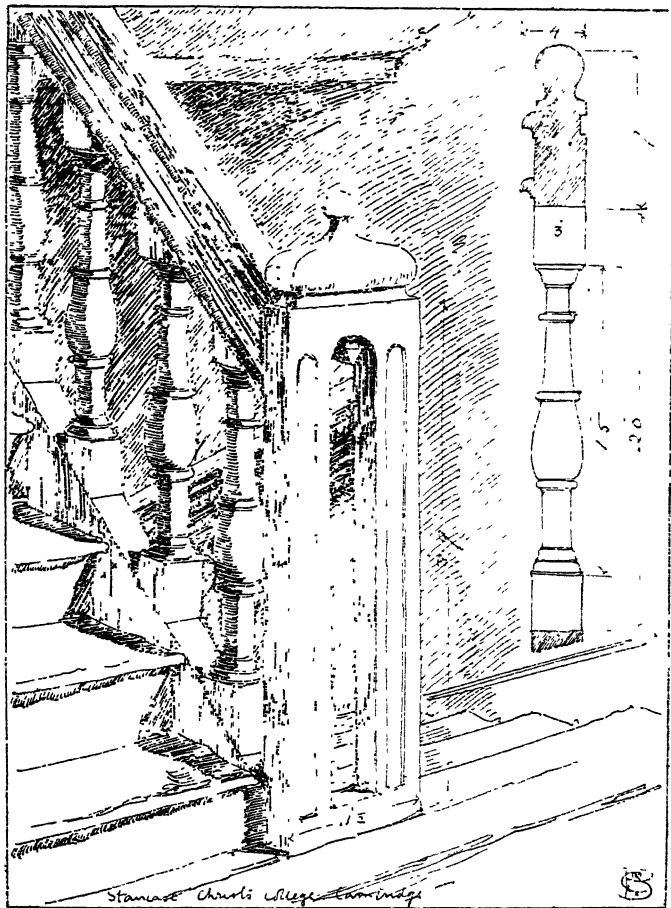

STAIRS, CHRIST'S COLLEGE, CAMBRIDGE.

often placed on the newels, as at Hatfield and Blickling, and the example from the old college at Wye in Kent. However picturesque these staircases may be, and in spite of the historical

interest of their associations and vicissitudes, their artistic value is small. In the larger examples every inch of the newels, strings, and balusters is covered with carving or mouldings: the carving is ill-considered, and seldom shows much regard for the structural intention of the member it decorates. The whole work shows an evident inability in the designer either to stay his hand or to conceive of a large architectural effect, apart from elaborate details.

The architecture of the hundred years, from 1520 to 1620, was in fact tentative. The builders were losing their old tradition, and had not yet replaced it by a new one, and on the other hand a certain sense of expansion and intellectual enfranchisement in the air at the time tempted them to bold experiments for which they were ill-equipped. So long as they adhered to plain building their work was admirable; but directly they attempted what they probably considered to be serious art they were on uncertain ground, and the result might be an elaborate and costly building, but it was seldom architecture. The specialization of building had already begun: the builder, instead of being an artist who built and designed in one and the same process, was already becoming a person who built buildings, and then thought it necessary to adorn them with ornamentation borrowed at random; and this conclusion is borne out not only by the buildings themselves, but by the rapid increase in architectural treatises and pattern-books, a sure sign of the increased demand for novelty, and of the recognized inability of the builder to meet it.

NOTE.—At the end of this volume plates are given showing Palladio's versions of the five orders taken from Fréart's "Parallel." Till the introduction of Palladio's orders into English architecture by Inigo Jones, that is to say, throughout Elizabethan and Jacobean architecture, the orders had been used at random, and without regard to the relations between their several parts, determined by the usage of either the Roman or the Italian Renaissance architects. Inigo Jones deliberately adopted Palladio's standard as the most mature and refined expression of the orders; and from his time forward, up to that of Sir W. Chambers, this was the accepted model. A knowledge of these orders is therefore essential to the student for the right understanding of later Renaissance architecture in England, and more particularly of the architecture of Inigo Jones. I have also added a diagram showing the best method of setting out the entasis and diminution of the column.

CHAPTER V

INIGO JONES

INIGO JONES was born on July 15th, 1573, in the parish of St. Bartholomew's, Smithfield. Little is known of the first thirty years of his life. The anonymous memoir prefixed to "the Most Notable antiquity of Great Britain, vulgarly called Stonehenge," etc., 1725, states that he was "early distinguished by his inclination to drawing and design, and was particularly taken notice of for his skill in the practice of landscape painting"; but the only clue to his early training is a tradition that he was apprenticed to a joiner in St. Paul's Churchyard.

Towards the end of the sixteenth century he paid his first visit to Italy, the anonymous memoir says at the expense of William, Earl of Pembroke, Sir Christopher Wren says, of the Earl of Arundel. Both these noblemen employed him on his second journey, but their connection with the first is uncertain. In the "Vindication of Stonehenge Restored" (1665) Webb states that "Christianus IV., King of Denmark, first engrossed him to himself, sending for him out of Italy, where, especially at Venice, he had many years resided"; and there is a tradition that, while in the service of the Danish Court, he designed several important buildings, such as the Castle of Fredericksborg, the Rosenberg Palace, and the Bourse at Copenhagen. It is, however, improbable that Inigo Jones designed any of these buildings. Webb wrote in a large manner without any too particular regard for accuracy. At the same time he would hardly have made an absolute misstatement of a fact which must have been within the knowledge of his contemporaries, and we may take it from his account that Jones was in the service of the Danish Court for some time previous to 1604, but probably was employed in a subordinate capacity, perhaps as draughtsman to Christian, who had a weakness for designing himself.

It seems clear that when Inigo Jones returned to England in 1604 he had some reputation as a traveller, but very little as an architect. For instance, when in 1605 the University of Oxford desired to entertain King James with three plays in the hall of Christ Church, they obtained the assistance of two of "his Majesty's master carpenters" and of the controller of his works for the construction of the stage. "They also hired one Mr. Jones, a great Traveller, who undertook to further them much, and furnish them with rare Devices, but performed very little of that which was expected. He had for his pains, as I heard it constantly reported, £50." It is evident from the amount of the fee paid that Jones already enjoyed a considerable reputation as a man of knowledge and resource, but there is no evidence that he was employed on any building at all, prior to his appointment as Surveyor to Henry, Prince of Wales, in 1610. Up to that date he seems to have been regarded as a man of ready invention and versatile capacity, and when he was not engaged in designing and superintending the scenery for the constant succession of masques at Court, he was employed on miscellaneous duties, such as that of King's Messenger. After his appointment as Surveyor-General to Prince Henry in 1610, he superintended certain repairs and alterations at St James's, Richmond, and Shcen; and in May, 1611, together with Francis Carter, Prince Henry's clerk of the works, he drew up an estimate "of the charge of the pyling, plancking, and brickwork for the three islands at Richmont," in order to carry out the design of Solomon de Caux, so that as late as the middle of 1611 it appears that he was not yet employed purely and simply as an architect. Walpole's speculation that to the period between his first and second journeys to Italy are to be assigned "those buildings of Inigo which are less pure, and border too much upon that bastard style which one calls King James's Gothic," is not supported by any evidence whatever. The earliest signed architectural design by Inigo Jones in existence is dated 1616, and there are drawings in the Worcester Library, dated 1617, for certain works in the Star Chamber; and the conclusion, suggested by all the evidence at present discovered, is that he did not settle down to the practice of architecture as his one absorbing art till after his return from his second visit to Italy.

Meanwhile he had already established his position at Court.

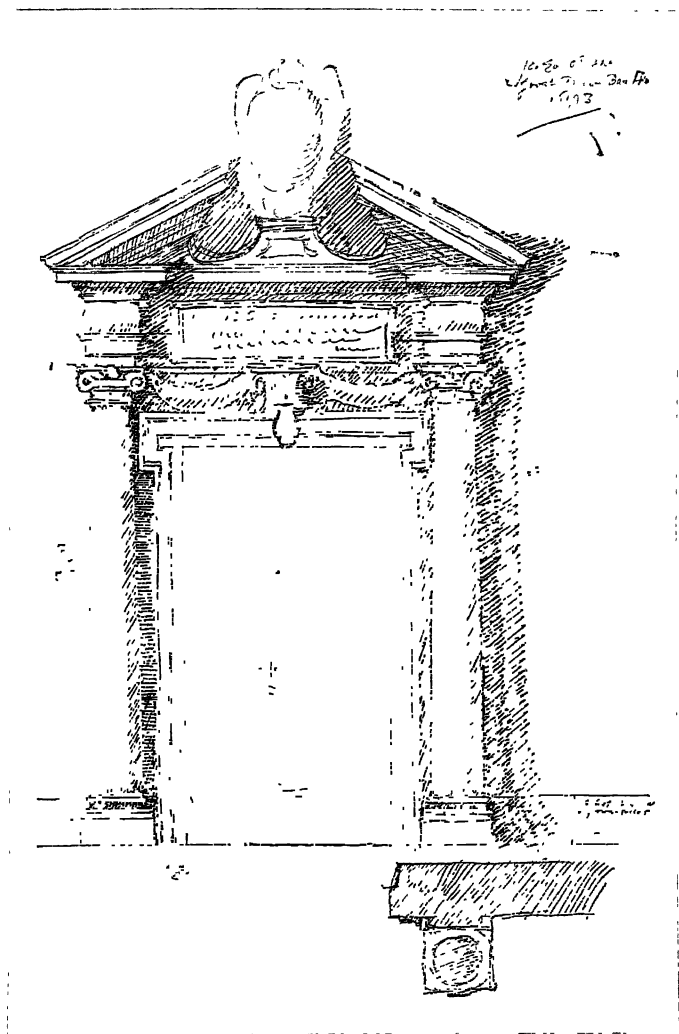

DRAWING FOR DOOR AT WHITEHALL.

He was on intimate terms with the Earl of Shaftesbury and other noblemen, and with most of the men of letters of the time, who were mainly dependent on him for the setting of their masques. The important work done by Inigo Jones in this regard hardly belongs to a history of architecture; but the fact that the best part of his energies for nearly ten years of his life (1604-13) was devoted to designing for masques justifies some reference to the entirely new departure which he introduced into stage scenery and management.

As is well known, the mechanical resources of Shakespeare's stage were quite primitive. No such thing as movable scenery existed. Its place was supplied by the "nuncupations only, in text letters," and the very form of the playhouse, in which the stage projected into the house, with galleries in front and at each side carried up to the back line of the stage, made such scenery impossible. The great improvements made by Inigo Jones were all developed from his initial change in the form of the stage itself. The stage which he used for the masques was set back behind the extreme ends of the side seats, and inclosed by an architectural or other border, much in the manner of the gigantic picture-frames which inclose the stages of modern theatres. Behind this, and out of sight of the spectators, he was able to provide the necessary room for scene-shifting. He worked his changes by means of painted slips, or, as he calls them, "shutters," with a large painted scene filling in the background. These shutters were rolled backwards and forwards on runners fixed at top and bottom, and pulleys were arranged at the sides to raise and lower the clouds. The floor of the stage was raised at the back eight feet above the floor of the house, with a fall of one foot to the front, and under the stage were placed windlasses and other contrivances for raising platforms, on which the masquers were introduced. Movable scenery was the most important improvement brought by Inigo Jones from Italy, and there can be little doubt that, inspired by the work of Baldassare Peruzzi, he greatly developed the mechanical resources of the stage all round. Lighting, for instance, was very carefully considered. Instead of the hanging candles and half-a-dozen footlights of the public playhouse, the stage for the masques was brilliantly lighted. In "The Masque of Queens" the friezes both above and below were filled in with various coloured lights "like emeralds, rubies, sapphires,

carbuncles, etc., the reflex of which, with our lights placed in the concave upon the masquers' habits, was full of glory." The sumptuous magnificence of the Renaissance, its pride of colour and glory of display, is surely indicated in this account. The years which Inigo Jones spent in Italy were not in vain. He returned to England filled with the very spirit of the great Italian artists of the Renaissance, and lifted the art of his country on to an altogether different plane. The homely fancy, the lovable humility, as one might say, of its traditional art were laid aside; the art of this country was to be no longer an affair of instinct, but completely conscious, dependent on scholarship almost as much as on capacity in design. Henceforward clear thought, and imagination under rigid restraint, were to supersede the poetry of mediæval fancy.

Inigo Jones was employed to design the scenery of the masques at Court in each year from 1605 to 1612, the year of Prince Henry's death. Except possibly in 1617, he was not employed again till 1621, after which he was regularly called upon to design the scenery whenever a masque was presented at Court. The last masque for which he designed was the "Salmacida Spolia," by Davenant, 1639-40, the object of this masque being to express the king's anxiety "by all means to reduce tempestuous and turbulent natures into a sweet calm of civil concord." On September 2nd, 1640, appeared the ordinance of both Houses of Parliament for "the suppressing of public stage-plays through the kingdom during these calamitous times."

After the death of Prince Henry in 1612, Inigo Jones's appointment of Surveyor of the Works lapsed, and early in the following summer he started on his second journey into Italy. The dates of his visit to Italy are surrounded with uncertainty. It appears, however, that he stayed in Italy from the middle of 1613 till the autumn of 1614, chiefly at Rome, Vicenza, and Tivoli, with perhaps a flying visit to England in January, 1614. His second visit to Italy was taken partly in the service of the Earl of Arundel, for whom he collected works of art; but the main object of his journey was further training in painting, and a thorough study of classical architecture, and it is evident from his notes that he had studied the writings of Serlio, Vignola, Fontana, Labacco, and Philibert de l'Orme, and was acquainted with the most famous architects then living in Rome.

In 1615 Jones succeeded Simon Basil as Surveyor-General of the Works, and in 1617 he prepared designs and a model for a new Star Chamber, and began the Queen's House at Greenwich. In the same year he began the new Chapel of Lincoln's Inn, which was consecrated in 1623. This chapel is the one certain instance of a design by Jones in Gothic architecture. There is no evidence beyond a vague tradition that he had anything to do with the Church of St. Catherine Cree (1628-30), but St. Albans, Wood Street, which was burnt in the Great Fire, is known to have been in the Gothic manner, and has always been attributed to Inigo Jones.

In 1618 he was appointed one of the commissioners to lay out Lincoln's Inn Fields, with instructions to prepare a plan for this purpose. There is an eighteenth-century view of Lincoln's Inn Fields at Wilton, which shows Lindsay House and the houses on the west side, with the rose and fleur-de-lis, which were designed by Inigo Jones some years later, and which are now the best examples left of his street architecture. Shaftesbury House (No. 55, Aldersgate Street, now destroyed) was another example. In the year 1619 he was ordered to design the new buildings at Whitehall. There are several variations in the published designs. Campbell published his set of plates in the "Vitruvius Britannicus," 1717-25, and states that he obtained the originals, which he dates 1639, from Mr. William Emmet of Bromley. These drawings are now in Worcester College Library. Campbell, however, is by no means to be trusted, for he also says that the Banqueting Hall was built in 1617, that is, two years before Jones was commissioned to make the designs. Moreover, it is pretty certain that the drawings from which he published his plates were not by Inigo Jones, but drafts by John Webb from the original designs made by Inigo Jones in 1619. William Kent published a set of plates in 1727, from drawings in the possession of the Earl of Burlington; these drawings also appear to have been made by Webb, and many of them are now in the collections at Chiswick and Chatsworth.

Besides the numerous variations in detail, two distinct sets of designs appear to have been made by Inigo Jones. The first (1619), and this is the set figured in Campbell from the drawings in Worcester College Library, was only about half the size of the subsequent design, the total dimensions being

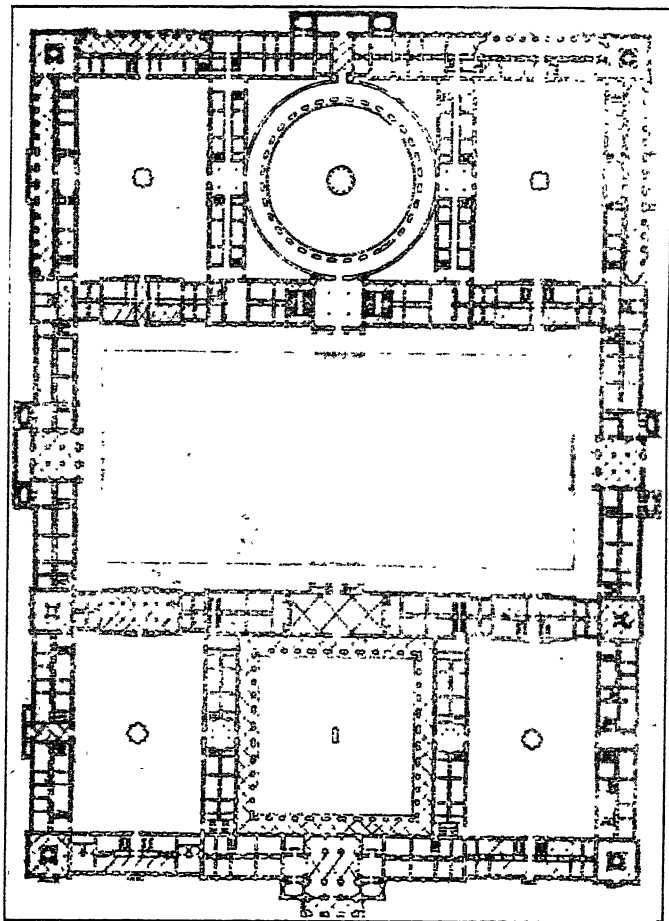

GROUND-PLAN, WHITEHALL.
(Worcester College Collection.)

630 ft. by 460 ft. The second, which is given by Kent from originals now at Chatsworth, was to be double the size, 1,280 ft. long by 950 ft. wide. The Chatsworth drawings are entitled "The ground plant for the palace of Whitehall for King Charles ye first taken John Webb, architect," and the elevation, "upright for the palace of Whitehall, for King Charles the first taken but the front is to be arranged (?) according to ye ground Plott John Webb." The meaning of this last provision was that it was to include Inigo Jones's Banqueting House, which was already built. It seems certain from this express reference to Charles I. that the original design was almost exactly doubled in size when Charles I. took up the Whitehall schemes. For instance, the great central court was 392 ft. by 198 ft. in Jones's original design for James I., whereas in the plan prepared by him for Charles I., and accepted, this court becomes about 800 ft. by 400 ft. So again, the circular court which in the first design had a diameter of 140 feet, has a diameter of about 280 feet in the later design preserved at Chatsworth. The astonishing thing is that, in spite of this heroic increase in scale, the original plan was to be preserved throughout. Roughly speaking, the site was to occupy the whole of the space from Whitehall Gardens to the ground at the back of the Treasury; and the plan was to consist of a huge rectangular block, 1,280 ft. long by 950 ft. wide. This was divided into three parts: the central division was to be occupied by an immense court, 800 ft. long by 400 ft. wide, running north and south; the division to the west was subdivided into three courts, of which the centre was the famous circular or Persian court, 280 feet in diameter, with oblong courts on either side; the division to the east, with front to the river, was also divided into three courts, the centre one square corresponding to the circular court, and the two end ones oblong. In one of the alternative schemes, the central court was to be occupied with buildings, but this idea was abandoned. The elevation was symmetrical, the composition consisting of a regular façade, with projecting blocks in the centre and at the ends, carried up above the intermediate range of buildings. The height to the top of the centre block was to be about 110 feet.

The work was begun in haste. The old Banqueting House had been burnt in January, 1619. Inigo Jones's design for the new hall and estimate of cost (£9,850) were completed in the

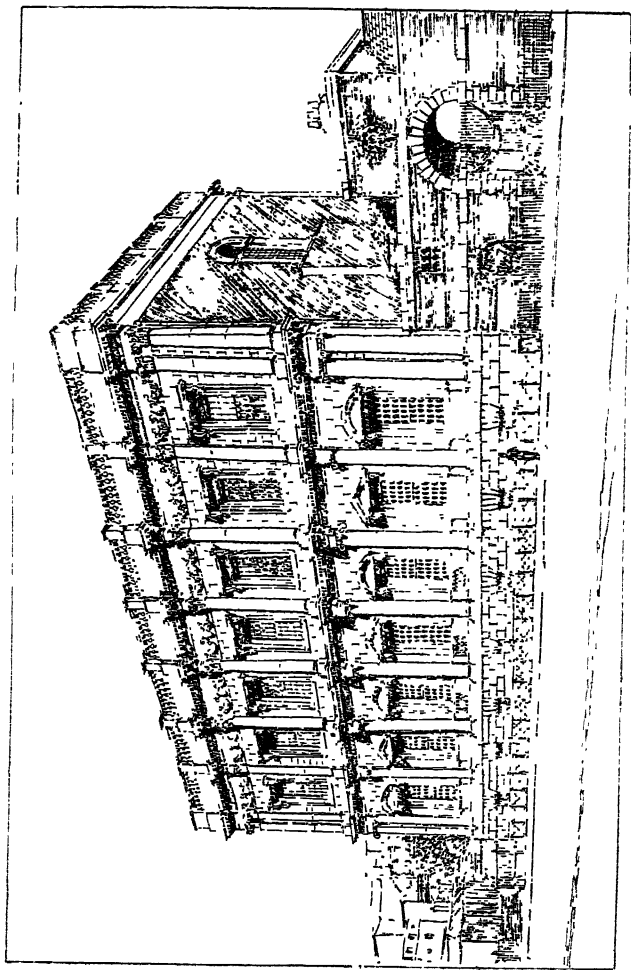

THE BANQUETING HALL, WHITEHALL.

spring, and the first stone was laid on June 1st of the same year. The new Banqueting House was completed March 31st, 1622, at a cost of £15,653 3s. 3d. This building, sumptuous as it is, was only intended as a subordinate feature of a vast façade, but it is the only part of the design that was ever carried out. Charles I. revived the scheme on a colossal scale, apparently between 1630 and 1640; but there was no money available, and the increasing difficulties in which the king became involved put a stop to any possibility of carrying out this magnificent design.

The boldness and originality of Inigo Jones's conception is amazing. It has appeared, from our survey of English architecture in the sixteenth century, how utterly wanting this art had been in what may be called architecture in the grand manner, that is, architecture on a great scale, and depending for its effect upon proportion and orderly distribution, that is, on the abstract and essential qualities of architecture, rather than on the accidents of detail. Throughout the Elizabethan age costly palaces had been built, such as Wollaton and Audley End, but not one of these great houses can be said to embody any large architectural idea. They are more or less picturesque masses of building, tricked out with adventitious ornament, which might be shorn away without materially injuring the architecture; the detail itself is usually wanting in refinement and distinction, and though these houses arrest our sympathy by their associations, considered from a purely critical standpoint, they only rank as second-rate work. There was, in fact, no precedent whatever in England for such a building as Inigo Jones designed for Whitehall. The force of his genius is shown in the fact that almost at one effort, and without previous failures, he was able to create a finished masterpiece of design in a manner that was as yet quite unfamiliar in England. The Banqueting House, mere fragment though it is of a stupendous design, is to this day the most accomplished piece of proportion in England, and not inferior to the finest work of Palladio and the great Italian masters.

From this time forward till the outbreak of the Civil War, Inigo Jones was constantly employed by the king. In 1620 he was made a member of a commission to inquire into all new buildings erected in London since the beginning of the reign of James I., and to enforce compliance with certain building

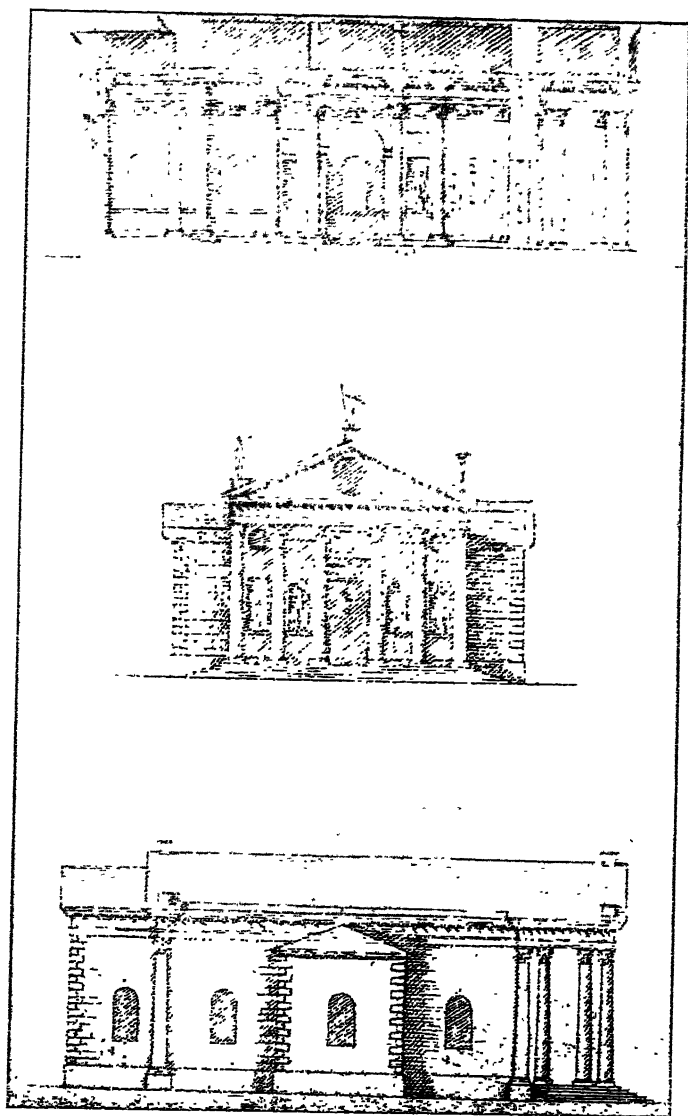

DESIGN FOR A CHURCH, PROBABLY ST. PAUL'S, COVENT GARDEN.
(Worcester College Collection.)

regulations. In 1626 he designed the water-gate of old York House, which was executed by Nicholas Stone. The gateway is still standing at the foot of Buckingham Street, Strand. A fine gateway, designed for Lord Weymouth, in Oatlands Park, near Weybridge, was pulled down about thirty years ago. The gateways of the Botanical Gardens at Oxford were designed, as well as executed, by Nicholas Stone; but it is possible that Inigo Jones gave the design for the south entrance porch of St. Mary's at Oxford. His next important work was the Church of St. Paul's in Covent Garden, and the laying out of the square. This church was begun in 1631, and consecrated by Juxon in 1638. It was burnt to the ground in 1795, but rebuilt on the old lines, and though it has been tampered with since, we have to this day substantially the original elevation; and, in fact, no architect but Inigo Jones could have made such an audacious design. The elements are very simple. A plain Doric portico, with a triangular pediment and a cupola above it, form the east elevation; but, as usual with Inigo Jones, his genius is shown in his treatment of these simple elements. Hawksmoor, with the same problem before him, would have blundered into clumsiness; but, as handled by a master, the great shadows of this portico, and the exact proportions of its parts, make it one of the most impressive façades in London. A comparison of this authentic building with such buildings as the inner court of St. John's, Oxford, and St. Catherine Cree, make it very improbable that either of the latter can have been designed by Inigo Jones.

Somewhere about 1620 Jones had been ordered to survey old St. Paul's. The cathedral was in a state of disgraceful dilapidation, but nothing was done till Laud became Bishop of London. In 1631 a commission was issued for the repair of the building. Laud succeeded in raising £101,300, and the works were begun in 1633, and continued till the outbreak of the Civil War, when the balance in hand was annexed by the Parliament. The scheme, it appears, was to gradually rebuild the cathedral, and Inigo Jones got as far as the south transept when the works were stopped. There is a view of the west front by Hollar, and a drawing of it at Chiswick. The design is inferior to Wren's, but it was much admired at the time, and Webb is enthusiastic over his "magnificent portico." It is to be noticed, moreover, both in regard to Wren and Inigo Jones,

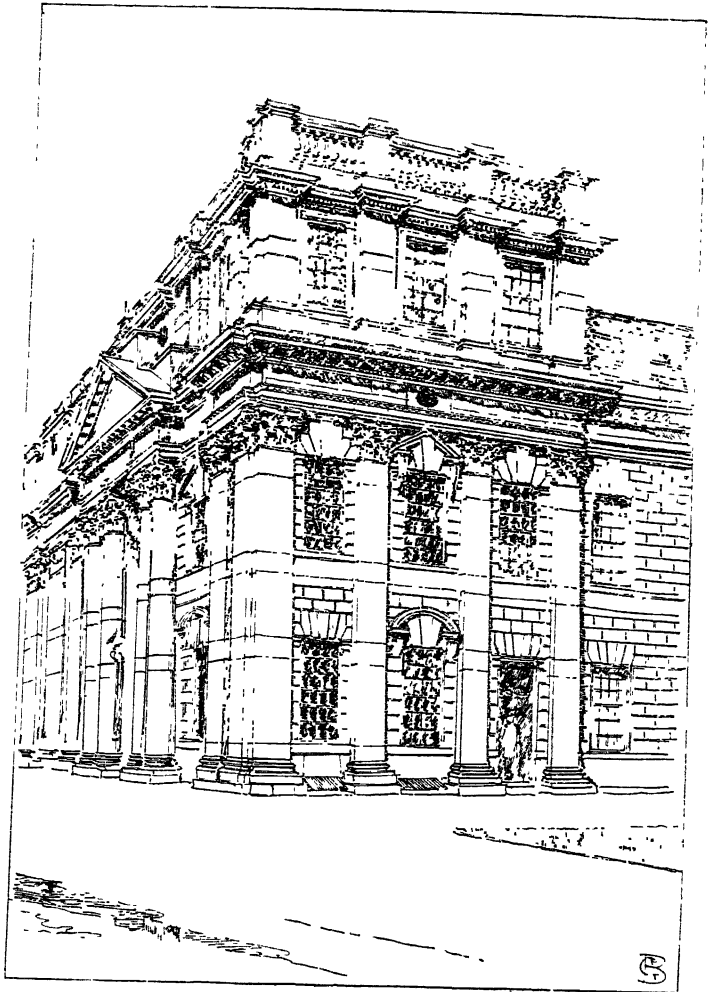

GREENWICH HOSPITAL.

that there is always a vast improvement in the building as executed, compared with the building as shown in their drawings. There can be little doubt that both men trusted far more to their actual supervision of the work, and to directions to be given as the building proceeded, than to their original draughts. They seem to have possessed a more intimate knowledge of building materials, and a keener insight into their artistic possibilities, than is possible to a modern architect, who, by the nature of his calling and the exigencies of contracts, is prevented from standing over his building from start to finish, and, so to say, shaping and moulding it on the spot into what he believes to be the most perfect form attainable.

The Queen's House at Greenwich was finished in 1635, the date carved on the building. In the Soane Museum there is a large folio of miscellaneous designs by Inigo Jones, Wren, and others, containing designs for Greenwich, which will be referred to in my account of Wren. Folios 8 and 9 show the river front and side elevation of what is called King Charles's block, which were undoubtedly designed by Inigo Jones, and these drawings may have been by his own hand. The masterly completion of this superb building is due to Wren, but to Inigo Jones belongs the credit of the original designs, and of having initiated a scale, which Wren alone was able to follow. In the same year (1637) the chapel of Old Somerset House was finished from designs by Inigo Jones, and in 1638 he prepared designs for additions and alterations to "the palace of Somerset House," three of which are preserved in Worcester College Library. The older parts of West Woodhay House, including the entrance porch, built 1635, are probably by Jones. In 1636 he designed the Barber Surgeons' Hall in Monkwell Street, the greater part of which is now destroyed, including the oval lecture theatre, shown in the drawing in the Worcester Library. This theatre was pulled down in 1782. In 1637-38 he designed the choir screen of Winchester Cathedral, since destroyed. One of his latest works in London seems to have been Lindsay House in Lincoln's Inn Fields, a fine stone-built house, completed in 1640. Two of the piers in front of the forecourt remain, but Hatton says that four of "the fine spacious brick piers" had been removed in his time, 1708. The date given for Shaftesbury House in Aldersgate Street is 1644; but Inigo Jones was then at Basing House, and it was probably completed at about the same time

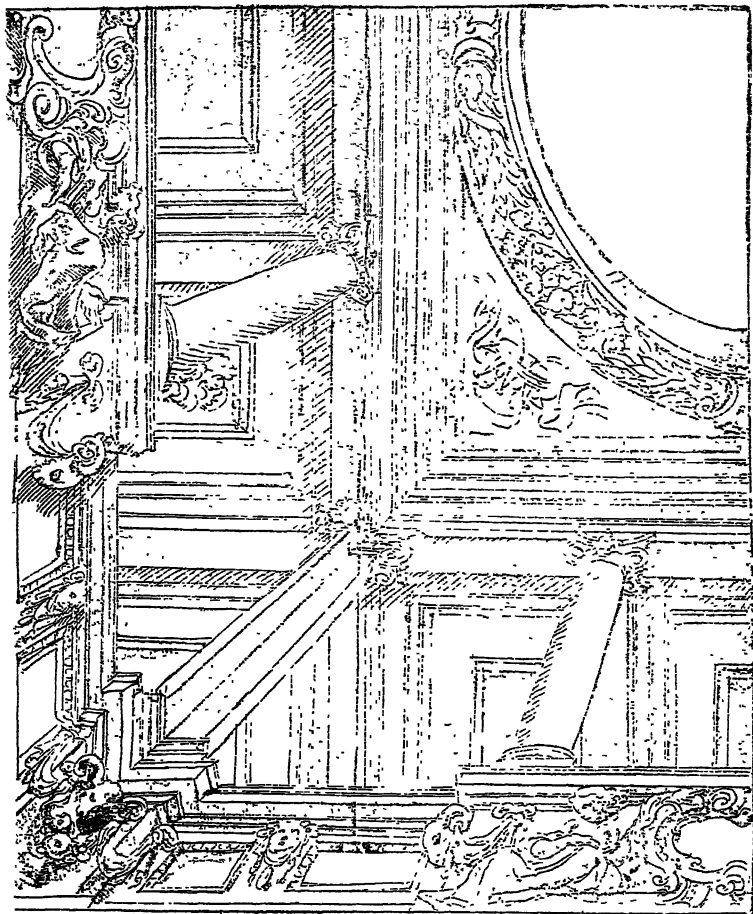

CEILING FOR WILTON, BY INIGO JONES.
(Not carried out.)

as Lindsay House (1640-42). Shaftesbury House is now destroyed. It resembled Lindsay House in its general design, and consisted of a basement storey supporting a single large Ionic order in five bays, which included two storeys.

On the outbreak of the Civil War, Inigo Jones left London, having, according to the tradition, buried his money in Lambeth marshes, with the help of his faithful sculptor, Nicholas Stone. His royalism and arbitrary character had made him unpopular with the citizens, and in 1643 he was deprived of his offices, and fled to Basing House in Hampshire, where he remained till the house was taken by Cromwell in 1645, after a siege of two years. Jones was fined £545 and £500.

After this stormy passage in his career he seems to have resumed his work unmolested, and to this period belongs his work at Wilton. Aubrey's account is that Charles I. persuaded Philip, 1st Earl of Pembroke, to build the garden front, intending Inigo Jones to design it, but as the latter was at this time (1633) occupied with the work at Greenwich, "he recommended it to an ingenious architect, M. Solomon de Caux, a Gascoigne, who performed it very well,"—that the south side of this house was burnt about 1647, and that it was then rebuilt from the designs of Inigo Jones, under the superintendence of John Webb. The fine drawing at Chiswick of the ceiling of the Cabinet room is dated 1649, and is undoubtedly by Inigo Jones, and there can be little doubt that the interior of the south block was entirely designed by him. He also recast the east elevation, but this and the north side of the house were altered by Wyatt towards the end of the eighteenth century, when the forecourt was shifted from the east to the north side, and all that is now left of Inigo Jones's work is part of the east side and the south block (partly altered), including the suite of rooms on the first floor, which appear to be in much the same state as they were left by him, for there is no finer example of his mature manner in existence in England. The great room, a double cube of 60 ft. by 30 ft. by 30 ft., with its panelling designed by Jones to receive Vandyke's portraits, is probably the most beautiful room in any house in this country, as the Banqueting Hall, also a double cube, of 110 ft. by 55 ft., is unquestionably the finest state room. Wilton is a peculiarly valuable example, inasmuch as parts of it, at any rate, are undoubtedly by Inigo Jones. Tradition assigns to him a great quantity of buildings in

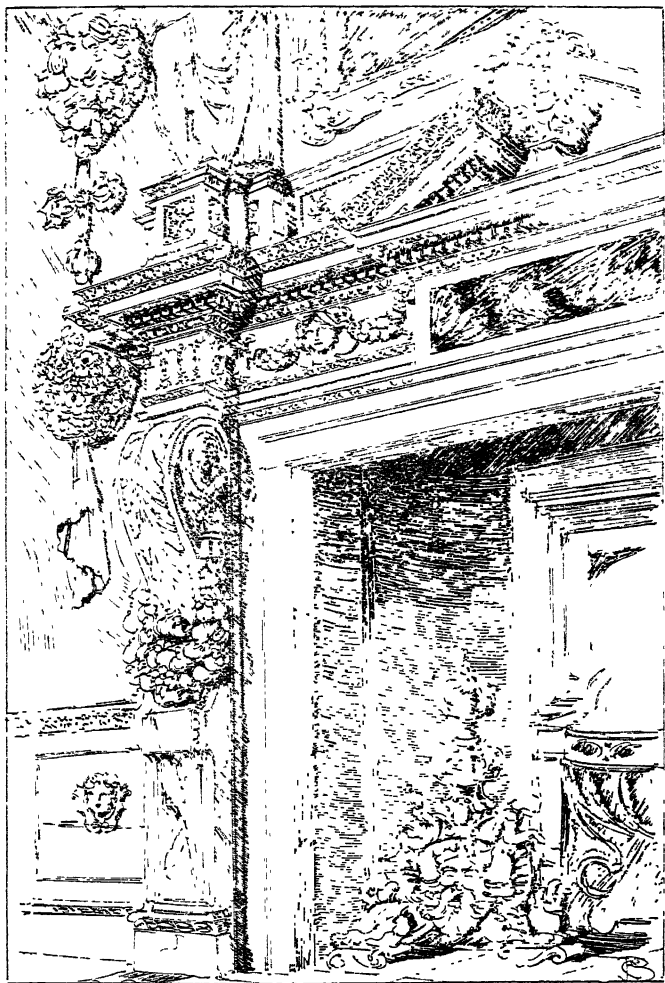

CHIMNEY-PIECE IN THE DOUBLE CUBE ROOM, WILTON.

England, but for many of these there is no authority, and the internal evidence of the actual design of the buildings is the only test which it is possible to apply. Raynham Park, in Norfolk, is an instance where the tradition is verified by the building itself. Quiet, reserved, and dignified in the highest degree, it stands by itself, apart alike from the mere picturesqueness of Jacobean work, and from the genial yet coarser manner of Wren. The house was built about 1636. Towards the end of the seventeenth century certain alterations were made in the internal decoration, and it is possible that the central pediment and Ionic order on the east side was added about this date; but the house is substantially unaltered, and abounds with refinements of design which show the unfaltering touch of a great master in architecture.

About 1647 Inigo Jones designed certain additions to Kirby, and prepared designs for rebuilding Durham House, of which there are drawings by Webb in Worcester College Library. There is also in this collection a drawing by Webb, entitled "Purfyle of ye Duke's Pallace at Cobham, 1648," which is probably the origin of the story which attributes to Inigo Jones the centre bay of the garden court of Cobham in Kent. It is possible that Inigo Jones did some work at Cobham, but the date on the pediment, 1667, proves that this particular façade cannot have been designed by him. Few architects have had so much work attributed to them as Inigo Jones, on no evidence but the vaguest possible tradition. There is no doubt that he did design many additions and alterations to existing houses, of which no documentary record exists, but in the case of such traditions the evidence of the building itself is the only clue. This at once eliminates the Jacobean work at Cranborne Manor, executed for Cecil soon after 1604, but will include among the list of his works the west wing with its great quoins and boldly projecting eaves. This wing was built in 1647, and is almost certainly by Inigo Jones. It is also probable that he designed the stairs and some of the ceilings at Ford Abbey, and the Grange in Hampshire, since entirely altered by Wilkins; and practically certain that he designed the whole of Coleshill in Berkshire. Coleshill is a late but singularly perfect example. It was built in 1650, and appears to have suffered no alteration since. This house may be taken as a typical instance of Inigo Jones's manner in the design of country houses. Castle Ashby in Northampton-

shire was begun by Inigo Jones, but interrupted by the Civil War. He is also said to have superintended the building of Stoke Park, Northamptonshire (1630-34), but the design was

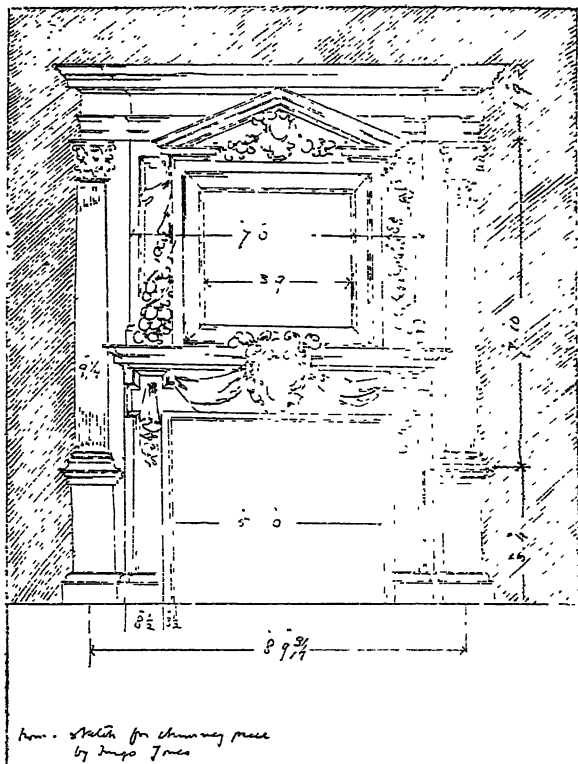

SKETCH FOR CHIMNEY-PIECE, BY INIGO JONES.

brought from Italy by Sir Francis Crane. Brympton, Amesbury, and Gunnersbury were by Webb, the two last possibly from designs by his master. The staircase and other details at Ashburnham House were probably designed by Jones, but carried out by Webb with variations just sufficient to miss the dis-

tinctive quality which Inigo Jones impressed on all his work. His latest design was one for the rebuilding of the College of Physicians, now preserved in Worcester College Library, dated 1651, and marked "not taken." He died June 21st, 1652, and was buried by the side of his father in the Church of St. Bennet, Paul's Wharf.

Inigo Jones was on the whole the greatest architect and one of the most accomplished artists that this country has produced. No man has mastered more completely the scholarship of his art; but to this range of knowledge he added a power of design and a quality of imagination which place him, as an artist, higher even than his great successor Wren. "It was *vox Europæ*," says Webb, "that named Inigo Jones Vitruvius Britannicus, being much more, than at home, famous in remote parts, where he lived many years, designed many works, and discovered many antiquities, before unknown, with great applause." The "antiquities" refer to his studies at Rome, for his theory of Stonehenge is not among his most memorable achievements. His extraordinary capacity is shown by the success with which he freed English architecture from the imbecilities of the German designers, and started it on a line of fresh development, borrowed it is true from Italy, yet so successfully adapted to English traditions, that it was at once accepted and followed by the best intelligence of the country for the next hundred and fifty years. His especial strength lay in his mastery of proportion, his contempt for mere prettiness, and the rare distinction of his style. His own theory of architecture was that, in his own words, it should be "solid, proportional according to the rules, masculine and unaffected." No man has ever more completely realized his own ideal of his art.

CHAPTER VI

JOHN WEBB, MARSH, AND GERBIER: THE LAST SURVIVALS OF GOTHIC

THERE can be little doubt that an architect of the reputation and constant practice enjoyed by Inigo Jones must have had some sort of staff of assistants. His only known pupil, however, is John Webb, and, in fact, with the exception of Webb, and the doubtful work of Gerbier and Marsh, the period of the Commonwealth is practically a blank in the history of architecture.

John Webb was born in 1611, and educated at Merchant Taylors' School. He seems, on leaving school in 1628, to have been apprenticed to Inigo Jones, with whom he worked as an assistant till the death of the latter in 1652. How far he also worked on his own account during any part of this period is uncertain. There is no doubt that he superintended the execution of many of the designs of Inigo Jones both during his lifetime and after, as at Ashburnham House (probably between 1650 and 1660), Wilton, Amesbury (rebuilt), Gunnersbury, and Greenwich. The brick houses on the south side of Great Queen Street have been assigned to Webb by Walpole, and were probably built by Webb while he was still working with Inigo Jones. Though by no means badly designed, they have none of the distinction of his master's work, and the capitals are very careless. During the Civil War, Webb sent plans of the fortifications of London to the king, at Oxford, a service which might have cost him his head; but he was able to resume work with Inigo Jones after 1645, and during the latter's lifetime he married his niece, and was appointed his executor. In 1655 he edited Jones's notes on Stonehenge, and in 1665 wrote "A Vindication of Stonehenge Restored," a loyal if ineffectual defence of his master's archæological theories. In 1653 he de-

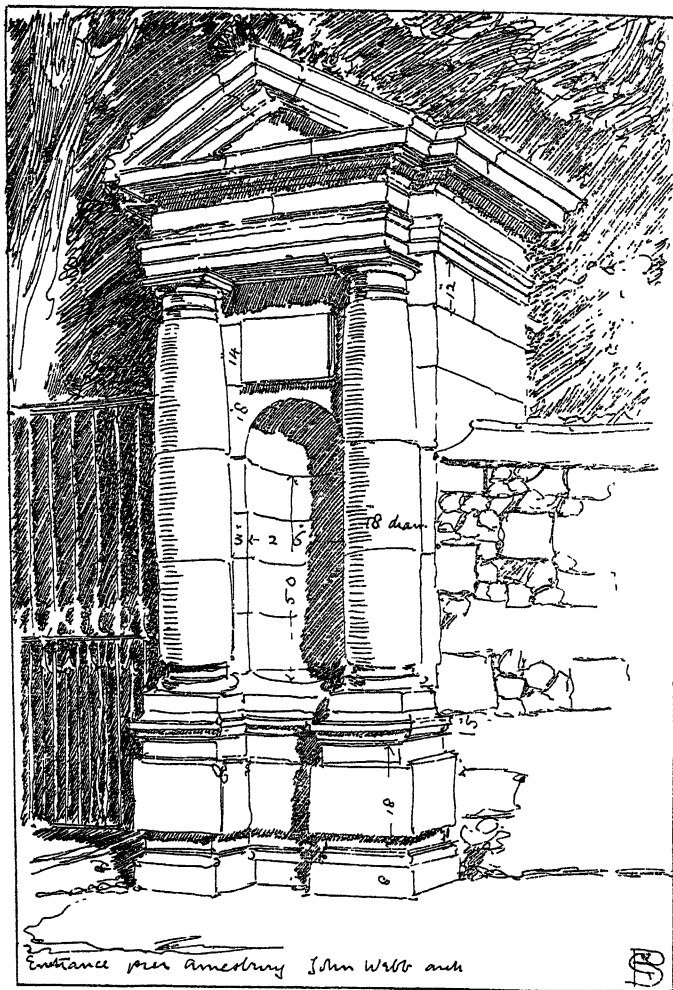

ENTRANCE PIER AT AMESBURY, BY JOHN WEBB.

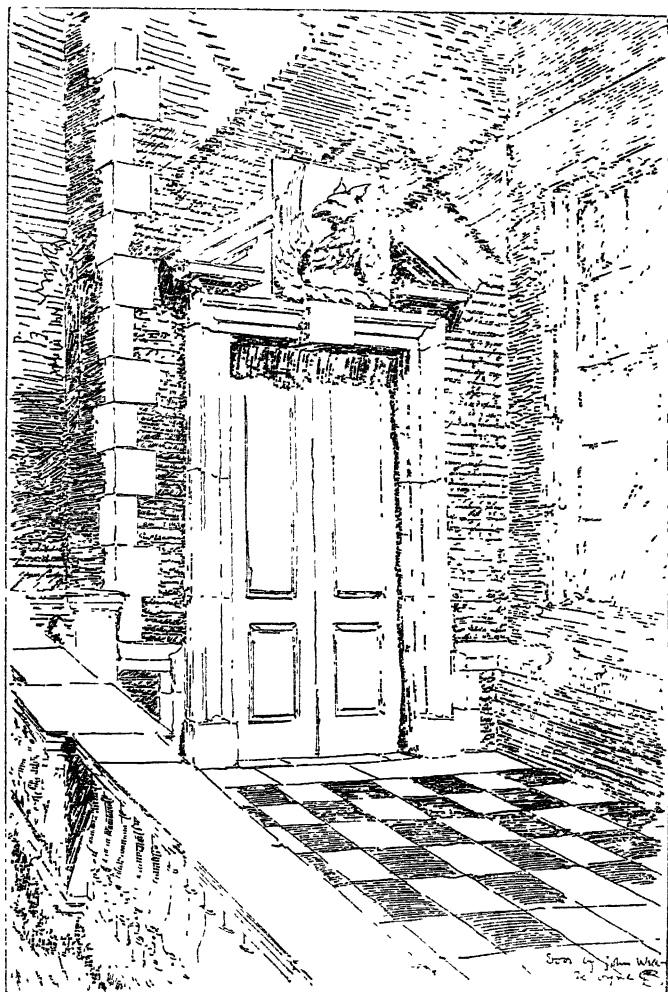

DOORWAY AT THE VYNE, NEAR BASINGSTOKE, BY JOHN WEBB.

signed some mantelpieces for Drayton, and in 1654 a large portico and summer-house and some other alterations at the Vyne, near Basingstoke, for Chaloner Chute, Speaker of the House of Commons. In 1656 he designed Thorpe Hall, near Peterborough, for Oliver St. John. Standing on rising ground above the Valley of the Nene, Thorpe Hall is a singular dignified building, and a good instance of that very interesting phase of architecture which extended from about 1640 to 1670, an architecture directly inspired by Inigo Jones, and as yet uninfluenced by Wren, and of which Colleshill is perhaps the most perfect and complete expression. The house, which is constructed entirely of stone up to the cornice, is boldly designed. In plan it is oblong, divided into four quarters by wide corridors, running north and south, and east and west. The grand staircase occupies the eastern arm of the corridor and leads to the principal rooms, which are, as usual, on the first floor, and arranged *en suite*. The interior of the house is richly decorated with panelling and plaster work; the latter is coarse but vigorous, and the carved open-work balustrade to the staircase anticipates the delicate panels by Grinling Gibbons, used afterwards by Wren for his internal woodwork with such excellent effect. The stables are more plainly designed than the house, but the same masculine scale is maintained throughout. The big centre gable closely resembles the gables of the riding-school at Bolsover, a resemblance which makes it probable that the designer of the latter was also a pupil of Inigo Jones. Thorpe Hall shows Webb's peculiarities in every detail, such as his affection for returned and mitred architraves, and other variations on the simpler methods of design. The general resemblance to Colleshill, built a few years earlier, is unmistakable. Webb had learnt from his master the value of bold, simple details, the necessity of avoiding fussiness of design, even at the cost of ugliness; but he had not attained that clear-headed intelligence which can see its way through a design from start to finish, and, in consequence, his work is sometimes violent without being strong. Yet Thorpe Hall is a fine design; in spite of a certain heaviness, it has the rare quality of maintaining its scale throughout, and that in a very exacting style. The extent of the advance, or, if it is preferred, the alteration, in English architecture brought about by Inigo Jones can be gauged by comparing Thorpe Hall with the charming little

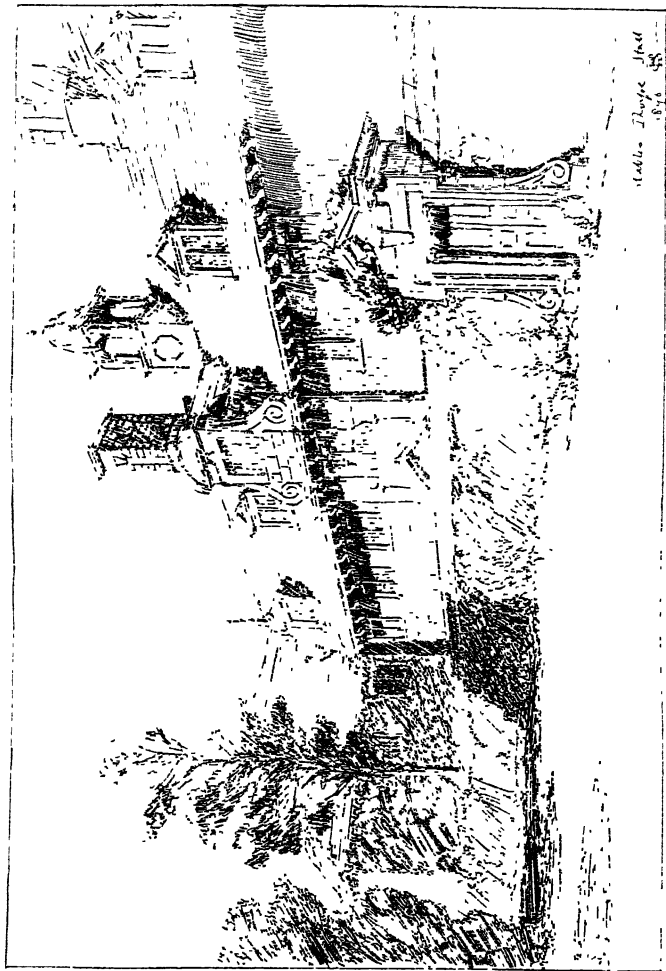

Stables Thorpe Hall
1876

THE STABLES, THORPE HALL.

manor-house of Stibington, about six miles off, finished in 1625, where the scale is, by comparison, that of a cottage, and the detail, in so far as it is intended for classical detail, is quite rudimentary. In 1657-58 Webb was doing work for the Earl of Northumberland at Northumberland House. There are drawings at Chiswick for some of the mantels, and a drawing for a house at Bishop's Burton in Yorkshire. In June, 1660, Webb made a petition for the place of surveyor of works, which the late king had designed for him in succession to Inigo Jones. The post, however, was given to Sir John Denham, and the reversion granted to Webb. In 1666 he was appointed assistant-surveyor to Denham, but on the latter's death in 1668, Wren was appointed surveyor, and Webb, perhaps in disgust at this discreditable abuse of patronage, seems to have retired to Butleigh in Somerset, where he built himself a house, since destroyed, and died on October 30th, 1674. His principal works, besides the above, were Gunnersbury, from designs by Jones, 1663 (rebuilt by Smirke in 1834); Burlington House, 1664-66 (remodelled for the Earl of Burlington in 1720); Horseheath Hall, Cambridgeshire, 1665; Bedford House, on the north side of Bloomsbury Square, since destroyed; Lamport Hall, Northamptonshire; Ramsbury in Wilts; Ashdown Park (shown in Kyp); and the execution of Inigo Jones's designs at Greenwich (1661-66), forming the western part of the river front.

Webb appears to have been a conscientious architect, able and intelligent, but not profoundly original. He worked in the manner he had learnt from Inigo Jones, a manner admirable in itself, but most difficult to handle, and there is little trace in his work of the learning and consummate reticence of his master. Yet he came of a splendid school, and nowhere is the saving influence of tradition in architecture more clearly seen than in the work of pupils of acknowledged masters.

Vertue, in Walpole's "Anecdotes" (ii. 175), mentions an architect of the name of Marsh, who designed the "additional buildings at Bolsover, erected after the Restoration," and Nottingham Castle. The "additional buildings" are the riding-school block at Bolsover, by far the finest part of the building, and a very powerful design. The bold rustication of the archways, the quoins to the dormers, and the breadth and vigour of the entire façade, suggest the influence of Inigo Jones, in spite

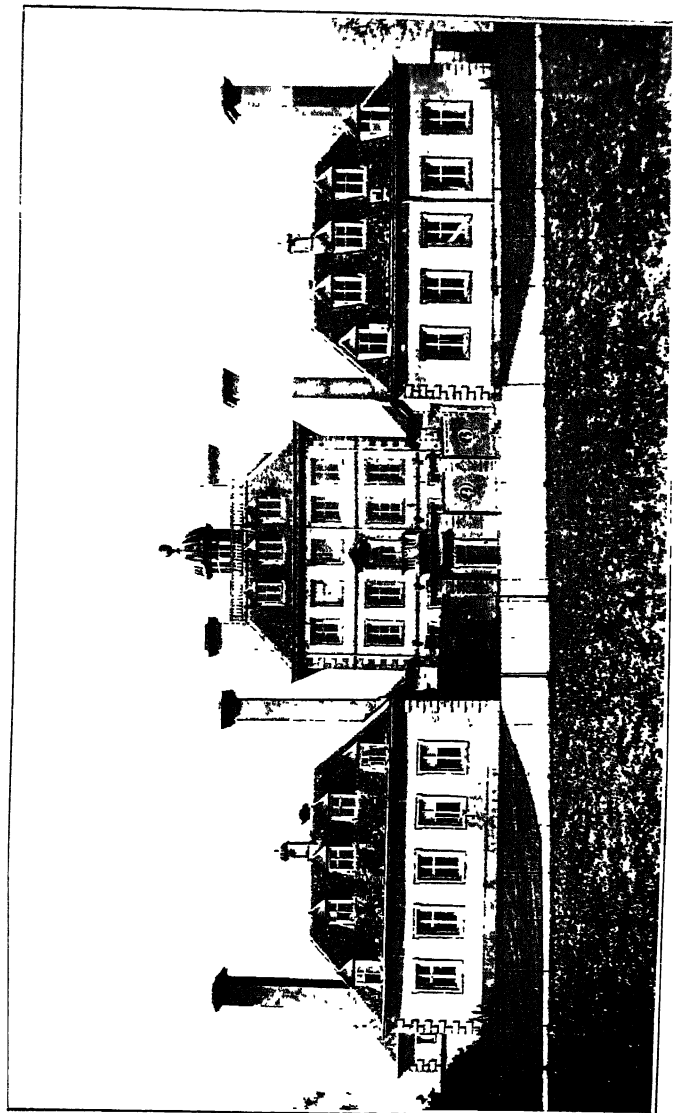

F. H. Ansh, Valboars me, photo.

of certain lapses here and there; and it is possible that this architect may have worked with Inigo Jones, though hitherto nothing further has been discovered about him. The same robust individuality can perhaps be traced in Nottingham Castle.

Sir Balthazar Gerbier credited himself with a fine building near the York Stairs water-gate, and published a small treatise on magnificent buildings, and another with the title of "Counsel

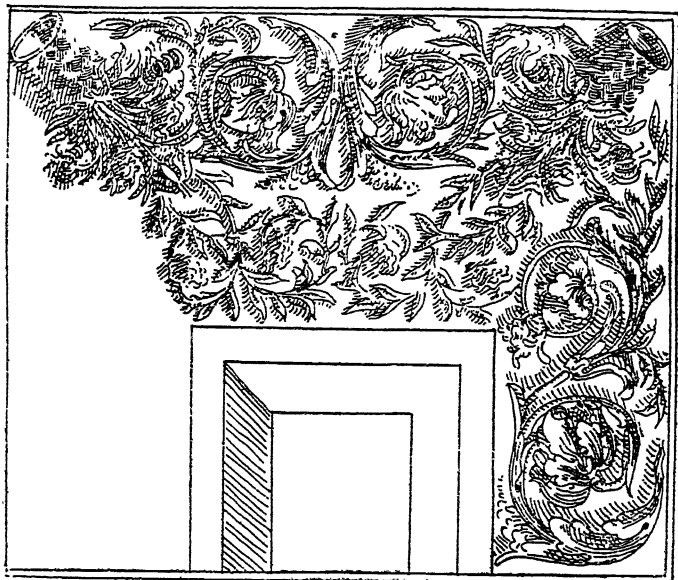

DESIGN FOR A CEILING AT GREENWICH, BY JOHN WEBB.

and Advice to all Builders," both in 1662. In the preface to "The 3 chief principles of Magnificent Building," Gerbier says that the place of Surveyor-General was intended for him after the death of Inigo Jones. Walpole says that he gave the designs for Hempstead Marshall (since destroyed), begun in 1662, and finished by his pupil, Captain Wynne; but this appears to be inaccurate, as Gerbier was in utter disgrace at the Restoration, and died in 1662. Gerbier is said to have designed the original

house for Lord Craven in 1620, in imitation of Heidelberg. This house was burnt, and it is not known that he had anything to do with the second house, which was designed and carried out by Wynne. Gerbier's work, however, is unimportant, and only of interest in so far as Gerbier, who was employed under both James and Charles I., lived till after the Restoration, and in this way forms a link between the times of Inigo Jones and Wren. He died in 1662.

Meanwhile the Gothic style had lingered on in the country, in spite of the example set by the Church of St. Paul's in Covent Garden. Bath Abbey Church, which was begun in 1499, was not completed till 1616, without any deviation in style from the original design. The best traditions of the style were lost before the end of the sixteenth century; yet almost down to the time of the Restoration a mason, when called upon to build a church window, fell naturally into the ways of late Perpendicular Gothic. It is, indeed, possible that the disappearance of Gothic as a distinct style was partly due to the check given to all church-building by the Reformation. Very few churches were built in the last half of the sixteenth century, and the records of any of the larger parish churches indicate clearly the puritanical trend of popular feeling in this regard. The artistic value of this later work is in consequence very slight. Its interest is mainly historical, as showing how intimately Gothic architecture was associated with the older religious motives, and how deeply rooted this tradition was in the minds of the English people.

During the reign of Elizabeth the money, which a hundred years before would have been spent in building new chapels and chantries, was, so far as church-building was concerned, devoted to sumptuous monuments of marble and alabaster. The existing churches were probably sufficient for the population, and the question was rather that of preserving the old than of building any new. In 1560 a proclamation was issued at Windsor against breaking or defacing monuments of antiquity set up in churches, and converting church bells to private uses; and, in consequence of the fire of June 4th, 1561, a commission was appointed to consider the repairs of St. Paul's and to procure funds. A considerable sum of money was raised, and the roofs were restored and covered with lead, but the steeple was not rebuilt; in fact, the church work of this time consists chiefly in repair and maintenance. Sometimes specific additions

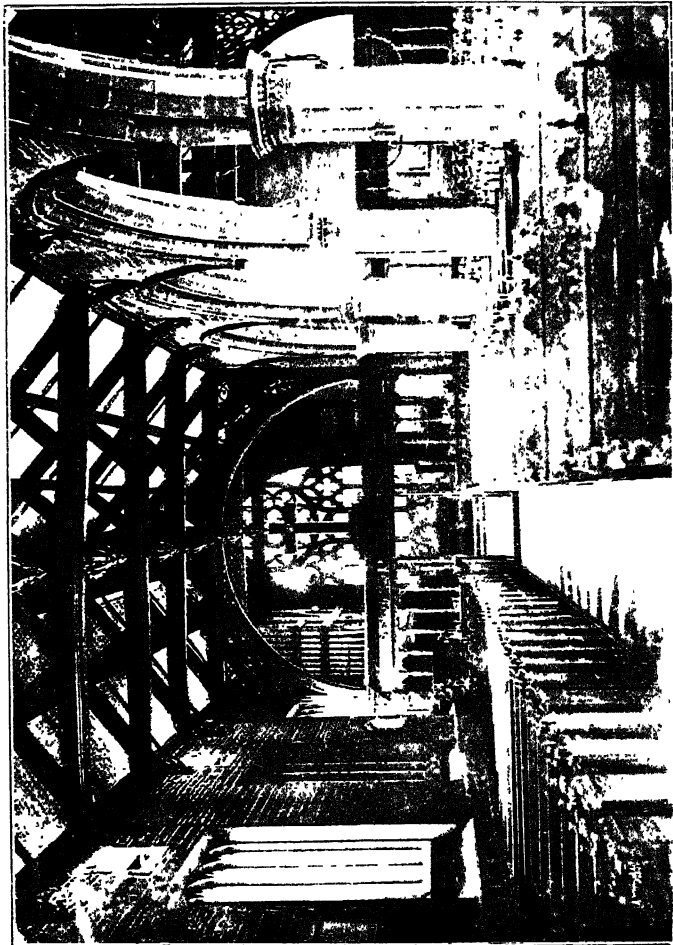

I. Wornald, photo.

ST. JOHN'S CHURCH, LEEDS.

were made, such as the gallery at the west end of St. Peter's, Wolverhampton, built at the cost of the Merchant Taylors' Company in 1610, but of actual church-building very little was done in the reigns of Elizabeth or James. The porch of Sunningwell Church, near Oxford, with rough Ionic columns and Gothic tracery, was built in 1562, and the tower of Probus Church in Cornwall, in 1570; Brancepath, Durham, in 1577, and Lower Peover Church in Cheshire in 1580. The tower and chancel, and probably the whole of the Church of Ellastone in Derbyshire, were built in 1586. Quarrendon Church in Bucks was restored by Sir Henry Lee about 1600; and Fulmer in Bucks, in 1610. In all these churches Gothic details were used, though often intermixed with strange variations of Renaissance motives, faint echoes of that far-away movement of which the country builder had heard, but as yet had no understanding.

On the other hand, the Puritan ideal was rapidly gaining ground throughout the country, and the meaning of the great Gothic churches was becoming a sealed book to the majority of Englishmen. Moreover, the Court of James I. was greedy, and indifferent to religion. In 1617 and 1618 licences were granted to search for treasures in abbeys and priories, such as St. Albans, Glastonbury, and Romsey; and probably much of the injury to shrines and monuments, attributed to Cromwell's soldiery, was actually done by the persons who obtained these licences. The poetry and mysticism of religion were lost to all but a few devoted men of exceptional imagination, and it was only the singular pertinacity of one great churchman which breathed fresh life into this dying spirit. In 1621 Laud was appointed Bishop of St. David's, and in 1626 Bishop of Bath and Wells, and between these years several of the west country churches were added to and repaired. Stalls and a new aisle roof were added to Sandbach Church in Cheshire, in 1620-33 and 1638. A new roof was constructed in Astbury and Barthomley Churches in Cheshire about 1620, and the galleries were put up in Nantwich Church in 1624. About the same time some of the midland churches were repaired. In 1626 Sir R. Banastre restored the chancel of Passenham Church, Northamptonshire, and added fresh seats and screens. The Church of Leighton-Bromswould in Huntingdonshire was built for George Herbert in 1626; and when the spire and part of the tower of Higham Ferrers Church, in Northamptonshire,

were blown down in 1631, they were rebuilt to the old design, and even, so far as was possible, with the old materials. In St. John's Church at Leeds we have a rare and interesting example of an entirely new church. In 1632-33, the old parish church being too small for the congregation, John Harrison, a citizen of Leeds, built the Church of St. John's, and endowed it with £80 per annum and £10 for repairs. In plan it consists of two aisles of the same size, treated throughout exactly alike, with a square tower at the west end of the north aisle. The aisle arcade has pointed arches, and both aisles have square-headed windows with cinquefoil lights. With the exception of the curious capitals to the pillars of the arcade, and leaving out of account modern restorations, all the details of the masonry are late Gothic, with slight technical variations, which will be noticed in dealing with the Oxford seventeenth-century Gothic. When, however, the carpenters, joiners, and carvers were turned into the church, Gothic detail was abandoned. The framing of the roof with its square plaster panels, the richly carved screen, running across the whole width of the church, with the two great semicircular arches and open strap-work spandrels, the details of the wainscot pews, the pulpit and the reading desk, are all of the ordinary Jacobean type, that is, based on German models, with variations according to the fancy of the workman. It is clear from this church and from similar instances, such as Water-Eaton, Lyte's-Cary, and Rycott, that the Gothic tradition was preserved in masonry long after it had died out in the other building trades. The same peculiarity is noticeable in the library of St. John's, Cambridge, built in 1623-24, for Williams, Bishop of Lincoln. The windows, and particularly the great oriel at the end, have fair decorated tracery in the heads, and the buttresses have crocketed pinnacles, but all the details of the woodwork are ordinary Jacobean.

It is probable, from the heterogeneous character of the details, that no architect was employed to design this church at Leeds. John Harrison may have given general directions, but the building as a whole represents the unaided efforts of different craftsmen working together without the control of a single mind. The result is undoubtedly picturesque, and the building is planned with excellent good sense in regard to the particular form of service contemplated. It has, however, the defect of its virtues. Though in the days when there was

but one inevitable style it was possible for workmen to produce homogeneous architecture without the control of an autocratic designer, this has not been possible since the Renaissance. In a less degree the men of the seventeenth century laboured under much the same disabilities as the modern architect. They had to select their manner of expression instead of having it ready to hand, and as much a matter of inheritance as their mother tongue. The consequence was that, where several men worked together, as it were all upon one plane, and yet independently, there was a certain confusion of speech and lack of cohesion, and such a result could not be avoided unless a single mind supplied the idea and controlled its execution down to the minutest details. A little later in the century, when the great school of the seventeenth-century architects was in full swing, this happy-go-lucky system disappeared; and though with it much that was interesting was lost, the greater lucidity of idea which accompanied the change was a distinct gain on the hazy thought of the unassisted workman; a tradition of sane and reasonable architecture was established, which lasted in this country down to the beginning of this century. It is on these grounds, and in view of the exceedingly complex conditions of modern architecture, that the idea of abolishing the architect and reverting to the combined work of independent craftsmen seems to me to be little more than an archæological fad, the last affectation of the Gothic revival.

In 1628 Laud was translated to London, and in the same year the rebuilding of the Church of St. Catherine Cree was begun. The uncertainty of purpose noticed in St. John's Church, Leeds, is found in St. Catherine's in an aggravated form. The nave arcades consist of semicircular arches brought down on to Corinthian columns without an intervening entablature, and the details of the external cornice, and the two southern doorways, are more or less based on Renaissance models; but the roofs are groined with ribs of a rough Perpendicular section, the clerestory and side windows have cinquefoiled heads, and the east window has five lower lights cinquefoiled, with a Catherine-wheel rose in the upper half, and more or less orthodox cusping. As has been pointed out in the last chapter, there appears to be no foundation for the tradition that Inigo Jones designed this church, and it is unlikely that any architect was employed. The church was

probably designed as well as executed by masons who worked indifferently in either style. The Church of St. Paul's, Hammersmith, consecrated by Laud in 1631, and since destroyed to make way for the present church, showed a similar mixture of styles.

There is abundant evidence of Laud's activity in the city churches, most of which were destroyed in the Great Fire. Thus, in 1631, £2,400 was spent in the repairs of St. Dunstan's, in the East. In 1632-33 the roof of the nave of St. Olave's, Hart Street, was rebuilt on the old lines, and probably the clerestory windows. In 1633 St. Alban's, Wood Street, was rebuilt by Inigo Jones, apparently on the old design. Matthew Wren, no less zealous than Laud in his desire to reform the service of the Church, completed the chapel and cloisters of Peterhouse, Cambridge, in 1632. Cosin, afterwards Bishop of Durham, who succeeded Wren, gave £390 towards the fittings, and introduced a crucifix on the high altar; and it is evident that the interior was richly decorated, for Dowsing, the iconoclast, reported that, in 1643, he and others purified Peterhouse Chapel in his usual way. In his Diary (for December 21st, 1643) Dowsing notes: "We went to Peterhouse, 1643, December 21, with officers and souldiers and . . . we pulled down 2 mighty great angells with wings, and divers other angells, and the 4 evangelists and Peter with his Keies over the chappel door, and about a hundred Cherubims and angells and divers superstitious letters in gold, and at the upper end of the chancel, these words were written as followeth: 'Hic locus est Domus Dei, nil aliud, et Porta cœli,' witness Will. Dowsing. Geo. Long." The glass of the east window was saved by being taken down and hidden away in boxes.

Abel's work at Abbey Dore Church (1634), which has been already described, is a good example of restoration as understood at the time. No attempt was made to replace the old work with copies, yet it is evident that Abel was conscious of its existence. The ceiling of the chancel, as rebuilt by him, is flat, carried by great oak rafters with carved brackets. These brackets spring from a slender shaft with an Ionic capital; but the proportions of this shaft are evidently based on the small engaged shafts of the original Early English work, and the shaft itself starts from the springing of the old groining. The effect is not very incongruous, and this method of dealing with

old buildings has the advantage of preserving every fragment of the old work possible, and of avoiding the falsification of history, which has resulted from the church restorations carried out in England during the last fifty years.

So again, where an addition was made to an existing church, no attempt was made to design the new work in laborious imitation of the old. At Cartmel Church, for instance, in 1640, George Preston, "out of his zeale to God, at his great charges, repaired this Church, being in greate decay, with a newe roof of

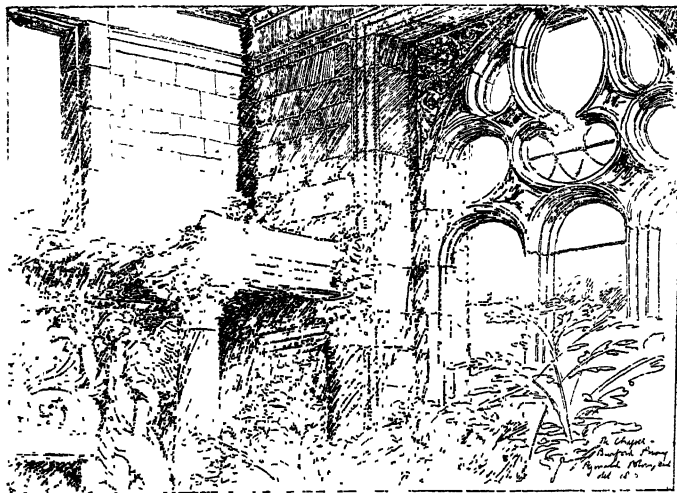

THE CHAPEL, BURFORD PRIORY, OXFORDSHIRE.

tymber, and beautified it within very decently with fretted plaister work, and adorned the chancel with curiously carved wood-work, and placed therein a pair of organs of greate value." The screens have detached oak columns, carved with vines, and Corinthian capitals. In the cornice are the emblems of the Passion, with bunches of fruit interspersed. The *naïveté* of this work, and its entire freedom from self-consciousness, are a refreshing contrast to the archæological pedantry of modern restorations.

The chapel at Lyte's-Cary in Somersetshire, and Rycott

Church, near Thame, are good examples of the survival of Gothic amid later details. Another well-known instance is the ruined chapel of Burford Priory in Oxfordshire, built after 1634 by Speaker Lenthall. The styles are mixed in this building with the most complete audacity. The chapel measures about 36 ft. by 12 ft., and appears to have been covered in with a stone segmental roof, the springing of the flat enriched ribs still remaining, though the roof itself has fallen in. A regular entablature with egg-and-tongue moulding runs round the interior, and the architrave is returned down the sides of the windows, the heads of which are filled in with tracery.

The Gothic tradition was tenaciously maintained at Oxford. When Sir Thomas Bodley built his schools he probably intended his tower to be a fine Renaissance composition, but the Gothic tradition creeps in at every point: in the groining of the gateway, the cusping to the windows, and the crockets to the pinnacles; and when a new college chapel was built, the Gothic method of fenestration was habitually followed. Wadham (1610-13) is a characteristic instance. The windows to the choir and the east window have fair Perpendicular tracery, but a curious variation is introduced into the windows of the ante-chapel: the tracery above the heads of the three lower lights has no cusping, but the oval in the centre has key-blocks, and the mouldings run out into scrolls. At Jesus Chapel the east window (1636) has good geometrical tracery, but no subordination in the mouldings, and in the side window of the Chapel of St. Mary's Hall (1632-44) the tracery starts from the mullions like cusping, and the fillets of the tracery do not meet. In Lincoln Chapel (1631) and Oriel (1637-42) the fillet of the tracery has a hollow channel sunk on the face. The famous staircase to the hall at Christ Church (1640) was built by Dean Fell, "by the help of — Smith, an artificer of London." The fan tracery and the central shaft are so good that, except for a slight attenuation of detail, this might easily be mistaken for work a hundred and fifty years earlier. The most remarkable instance at Oxford is the latest. Brasenose Chapel was completed in 1666. The north window of the ante-chapel has flowing geometrical tracery, but is framed into an architrave with a broken pediment above, and the side windows of the chapel have pointed heads and geometrical tracery, but are flanked by pilasters with Corinthian capitals, supporting a regular entabla-

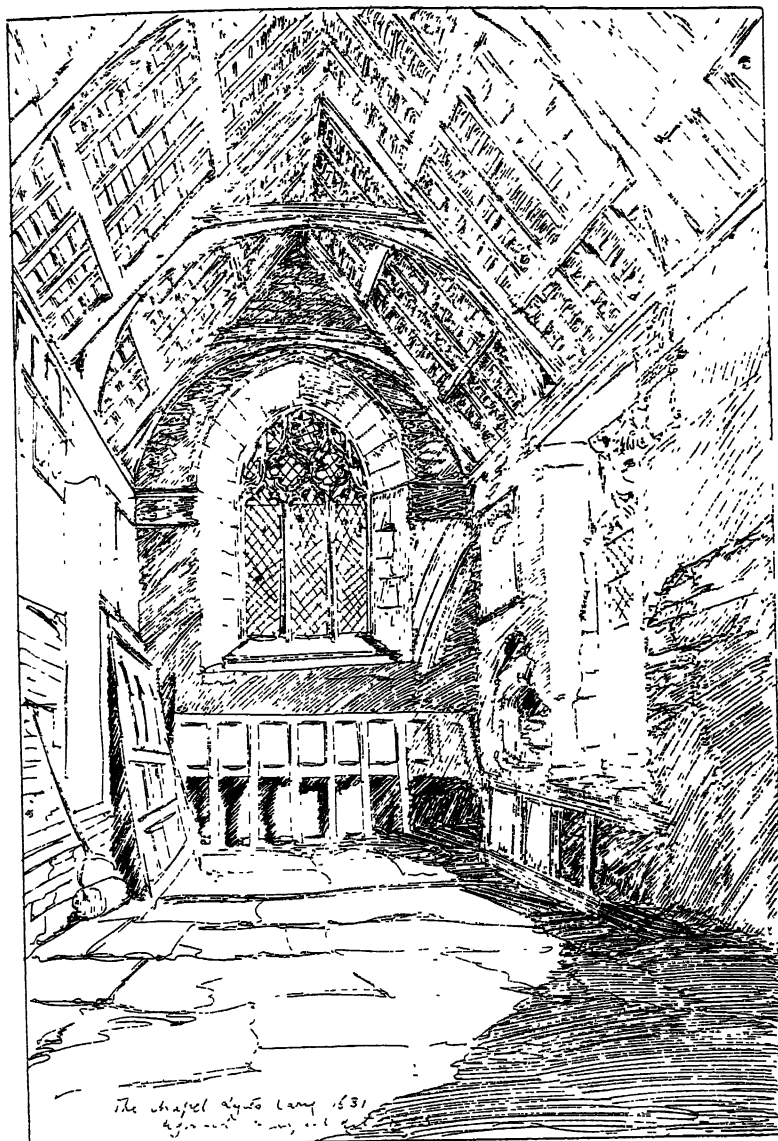

THE CHAPEL, LYTE'S-CARY, SOMERSET.

ture. Indeed, this Oxford seventeenth-century Gothic is the most curious in England. It persistently peeps out through Renaissance ornaments and classic frontispieces—cusps and crockets mix indiscriminately with orders and entablatures. Oxford, in fact, remained essentially mediæval till the clash of the Civil War broke in upon her dreams.

A similar mixture of styles occurs in the Church of Berwick-on-Tweed, built by Colonel Fenwicke, the governor, 1648-52. This church has a nave, and north and south aisles. The nave arcade has plain semicircular arches, brought down without any entablature on to the abaci of Tuscan columns; but the clerestory windows have three lights with cinquefoiled heads, the centre-light stepped up above the two side-lights, as at St. Catherine Cree's. There is no tower, but two octagonal turrets with cupolas at the west end. In this case it almost seems as if the church was begun by a mason with classical tastes, and finished by one who preferred the Gothic. The latest example of a complete Gothic church is Charles Church at Plymouth, built in about 1657, though the upper part of the tower was rebuilt in 1708, and some atrocious wood-work was added at the end of the last century. With these exceptions, the church is entirely Gothic; all its details were copied from those of St. Andrew's, Plymouth, which was completed in 1460, and there is more of the feeling of late fifteenth-century work in this church than in any other of so late a date.

The instances given above of the survival of Gothic could easily be added to. Bishop Hacket's work at Lichfield, for example, and Bishop Cosin's at Bishop-Auckland were inspired by the same motives and followed the same methods as the work undertaken by Laud and Matthew Wren, and the impulse lasted down almost to the end of the seventeenth century. The tower of Warborough Church, near Shillingford, bears the date 1666, but might easily be mistaken for work a hundred years earlier, and it is very probable that, in some cases, work which has been assigned without hesitation to the fifteenth and sixteenth centuries was actually done at least one hundred years later. The latest examples of Gothic are said to be Welland Church, 1672, and the chancel and tower of Hanley Church, 1674, both in Worcestershire. Gothic details of a sort were of course used in the eighteenth century; these, however, were deliberate revivals and copies, and are different in character from these last sur-

vivals of Gothic, the work of the country builder who, more or less, consciously adhered to the old tradition.

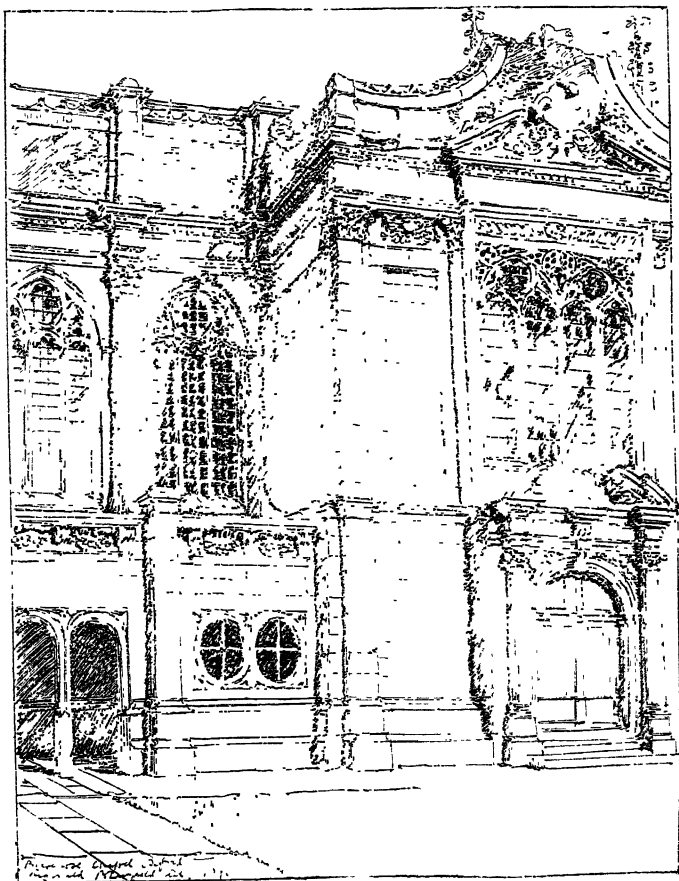

THE CHAPEL, BRASENOSE COLLEGE, OXFORD.

I have sketched this curious chapter of architectural history, not so much on account of its artistic importance as on account

of its historical interest. Artistically, this late Gothic is inferior work, the detail mechanical, the execution ignorant and slovenly, it was the expression, not of men working freely in the full enjoyment of their traditional craft, but of workmen behind the time — of men brought up on a past tradition, who clung tenaciously to a half-forgotten art. On this ground alone it is profoundly interesting. It is clear indeed from this dying effort that Gothic architecture was still most intimately associated with the religion of the English Church. The magnificent freedom of Renaissance art had no attraction for such men as Herbert and Crashaw. In this last flicker of mediæval art we find the fit architectural expression of that religious mysticism, which flamed out in dying brilliancy to resist the approach of Puritanism, and which, indeed, from one point of view, might itself be taken as the last serious effort of the mediæval world. But the energies of that world were now finally scattered. The conditions under which Gothic architecture had grown to its splendid maturity had long since ceased to exist, and could never be recalled. Some attempt was made in the last century, though, indeed, but half in earnest, to revive mediæval art, and in this present century the attempt has been made again with a devotion as intense as it was uncritical. It is, perhaps, not premature to say that this second endeavour is sharing the fate of the first. History follows its own irresistible course, and enthusiasm, however amiable, is foredoomed to failure unless it can place itself within the lines of the inevitable development of facts.

CHAPTER VII

SIR CHRISTOPHER WREN

THE extreme gravity of the historical events which occurred in England between 1640 and 1660 threw architecture and the arts into the background, and it is owing to this apparent check that an undue distinction has been made between Wren and Inigo Jones. The stream of development was never in fact arrested. Webb, the pupil of Inigo Jones, was in full practice after the Restoration, and came into collision with Wren on the question of the Surveyorship. Captain Wynne, the pupil of Gerbier, did not complete Buckingham House till 1705, and the versatile Gerbier himself was advocating his own claims for employment after 1660; but the most important evidence in regard to the continuity of the English Renaissance is to be found in the fact that, the more Wren advanced in mastery of his art, the more nearly he approached to the manner of Inigo Jones. The reason for the divergence of Wren's earlier work from the models left by his predecessor is to be found not in any change of ideas, but in Wren's training, or rather in the absence of it; for it was only by slow degrees and large experience of work that Wren attained to certainty of taste and the full maturity of the accomplished manner of his later years.

Christopher Wren was born at East Knoyle in Wiltshire on October 20th, 1632. After four years at Westminster, under Dr. Busby, he entered at Wadham College, Oxford, as a Fellow Commoner in 1649, and very early gave evidence of his singular ability in applied science as then understood. Throughout his career Wren showed an extraordinary capacity for assimilating knowledge and reducing it to practical shape. His theoretical speculations were never of any great value. In spite of his wide mathematical knowledge, Wren did not approach scientific problems from the point of view of a thinker such as Newton.

His intellect was in this regard of a different calibre. Instead of seeking to establish any of those far-reaching principles which lay the ground-work for new departures in scientific discovery, Wren used his knowledge for entirely practical purposes. He invented a water-clock, a pavement "harder, fairer, and cheaper than marble," a method of staining marble red, and other ingenious novelties which have long ceased to be of the slightest value. Wren's practical consciousness and extreme fertility of resource would, under modern conditions, have made him one of the most consummate engineers that have ever existed, but in this very comprehensiveness lay the single weakness of Wren as an artist. His interest in the various aspects of building was so evenly balanced, that he sometimes found himself unequal to that stern restraint in art, without which the highest qualities of architecture are unattainable.

In 1653 Wren was elected to a fellowship at All Souls', and for the next few years was busy with the meetings at Wadham and Gresham College, which led to the foundation of the Royal Society. In 1657 he was appointed Professor of Astronomy at Gresham College, and in 1661 Savilian Professor of Astronomy at Oxford, and in the following year he declined an offer from the king of a commission to survey the fortifications at Tangiers and to superintend the building of the new works. This offer was due to the influence of Evelyn and Matthew Wren; otherwise it is remarkable that such an offer should have been made to a man whose reputation rested entirely on his scientific attainments: for Wren had as yet no training in architecture or practical acquaintance with building, and though in the end he more than justified the favour which led to his becoming an architect, his early works suffered from this absence of any sufficient training, and the fact that he was nearly thirty before he turned his attention to architecture.

In 1661 Wren was appointed assistant to Sir John Denham, the Surveyor-General of Works, from whom he can have learnt very little, and his first work was Pembroke Chapel at Cambridge for Matthew Wren (1663-64), a simple and well-proportioned design, though quite incongruous with the adjacent buildings. In the same year he began the Sheldonian Theatre at Oxford, which was completed in 1668. Wren's knowledge of mechanics found its opportunity in the roof, which has a flat ceiling with a span of 68 ft.; but as yet he had not attained to the suavity



J. Valentine, photo.

P. 110.

TRINITY COLLEGE CHAPEL, OXFORD.

(BY SIR C. WREN.)

of manner found in his later work. The inside is uninteresting, and the details of the exterior coarse and heavy.

In 1665 Wren designed the inner court of Trinity College, Oxford, and in the summer of this year started for Paris, where he stayed till the following Christmas, "Surveying the most esteemed fabrics in Paris and the country round" and making it his business "to pry into trades and arts." No better school of architecture was to be found in Europe at the time. The Louvre was then being built from the designs of Bernini, and Wren had introductions to the brilliant group of artists brought together by the intelligence of Colbert. That he made full use of his time is proved by his subsequent work. Wren never went to Italy, and this six months' stay in France was the only period of studentship that he ever went through. On his return to England, he was at once immersed in the business of a most laborious career, which allowed him no leisure till he reached extreme old age, and his rapid advance in technical skill was gained by experiments in actual building. In all the earlier work of Wren's middle period, the influence of the French architects is very marked; but it gradually disappeared towards the end of the seventeenth century, and in his later work he shook off the exuberant ornament which disfigures some of his earlier designs.

It is evident that Wren's connections, and his distinguished reputation as a scholar and mathematician, brought him quickly into prominence as an architect. As early as 1662 he was consulted on the repairs of Old St. Paul's. Only part of the scheme proposed by Inigo Jones had been carried out, when the works were stopped by the Civil War; and the building was now in a very dangerous condition. The tower was unsafe, and the nave roof was thrusting out the walls. Wren proposed to build "a light thin shell of stone very geometrically made" as a roof, and to replace the tower with "a dome or rotunda, and upon the cupola for outward ornament, a lantern with a spring top to rise proportionately." It is evident that his secret intention must have been to gradually rebuild the cathedral on the lines begun by Inigo Jones, leaving certain portions of the old work inside. The question was raised in earnest in 1666, and Wren got out his designs. Four of the drawings, dated 1666 and signed, are preserved in the Library of All Souls', Oxford. The old choir was to remain, with the exception of the end bay westward; and

the outline of the steep lead roof of the nave was to be preserved, but pilaster buttresses with obelisks as terminals were to be added. Over the crossing was to be the new dome, consisting of an inner dome of masonry and an outer dome covered with lead with a lantern at the top surmounted by a huge open-work pineapple, 68 ft. high, of monstrous and horrible design. The only attractive feature in this scheme was the double flight of eighteen segmental steps, leading from the crossing under the dome to the old choir. The fire of London, which began September 2nd, 1666, saved Wren from attempting to realize this impossible idea.

The Great Fire was Wren's opportunity. The city was "a ruinous heap"; and Wren, who had succeeded Sir John Denham as Surveyor-General in 1668, had the field pretty well to himself. He at once drew up a masterly plan for laying out the city, which the king accepted; but the necessity of immediate rebuilding, difficulties of compensation, and the want of money prevented the scheme being carried out. The area covered extended from the Temple Gardens on the south to the end of Fetter Lane on the north, and ran north-east by Hosier Lane, including Newgate, Aldersgate, and Cripplegate in the east. It stopped short of Broad Street and Leadenhall Street, but extended south-east in an irregular line to the east of Billingsgate, the Custom House occupying the extreme south-east corner. The three main features, going from west to east, were to be: (1) a circular space on the crown of Fleet Street Hill, about on the site of St. Dunstan's Church, from which eight streets radiated in straight lines, connected by cross streets laid out on an octagon plan in relation to the circular space; (2) a triangular space, to include St. Paul's and Doctor's Commons, gradually widening out eastwards as it ascended Ludgate Hill; (3) the Royal Exchange, on the old site, but placed in an open space, surrounded by the Post Office, the Excise Office, the Goldsmiths' Insurance Office, and the Mint. Wren intended this to be the centre of the City, and from it were to radiate ten streets each sixty feet wide. A broad quay was to run down the river bank, and, by means of straight streets, the Exchange would be seen from three separate points on the quay. Opposite the end of London Bridge there was to be a large semicircular space, with arms radiating outwards to join the other streets. The scheme was indeed worthy of Wren's genius, and, had it been carried

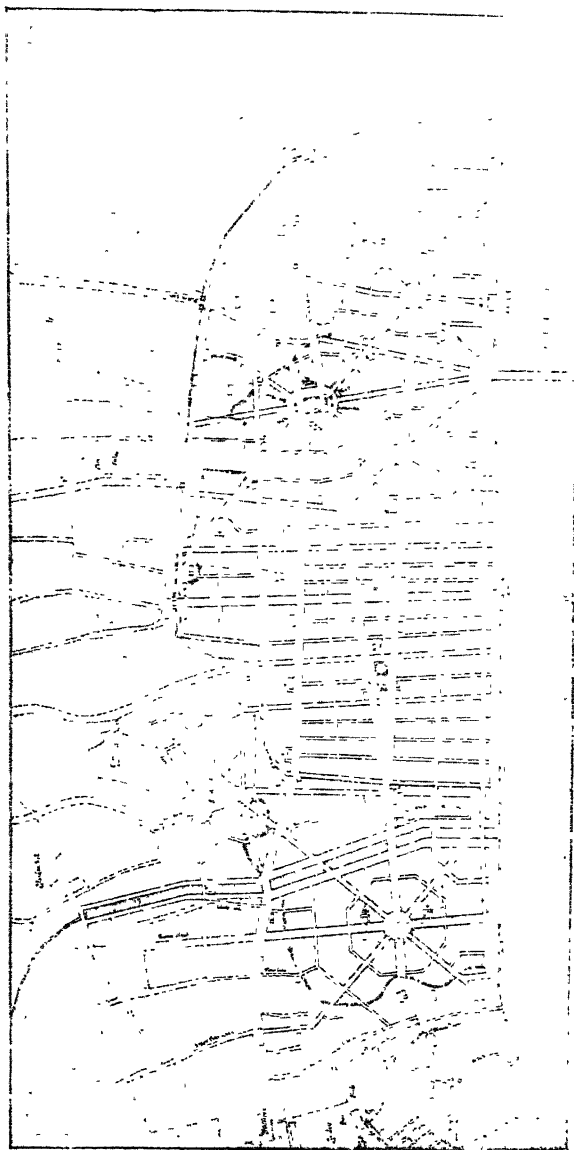

WREN'S PLAN FOR REBUILDING LONDON.
(All Souls' College collection.)

out, would have made the City of London one of the most beautiful in the world. Wren's fine intelligence grasped the full architectural possibilities of vistas of broad straight streets, linked together by groups of public buildings, the importance of a commanding site for these buildings, and the absolute necessity of a complete and consecutive scheme to the dignity of a great city, as opposed to a mere farrago of houses. Unfortunately, his scheme was never even attempted.

Wren next turned his attention to the rebuilding of the City churches and St. Paul's. The two occupied him concurrently for the next thirty-eight years; but though the latter is far the more important work, it will be more convenient to deal with the churches first, as these, to some extent, represent Wren's tentative efforts, the mature results of which are to be found in the details of St. Paul's. In dealing with the City churches Wren had an exceedingly difficult problem. A great many of the sites were very irregular, the resources available were limited, and Wren had to adapt his buildings to severely Protestant requirements. Moreover, he had no precedents to refer to, from the conditions of the case. Wren, however, surmounted these difficulties with conspicuous success; and probably in none of his works is his fertility of resource more evident than in his City churches. The problem before him was to provide the most practical and economical church possible for a Protestant congregation, and Wren had very clear ideas as to the proper way to set to work. In the report which he wrote as one of the Commissioners of Queen Anne's Act of 1708, for building fifty new churches, Wren says: "It would be vain to make a Parish Church larger than that all who are present can both hear and see. The Romanists, indeed, may build larger churches, it is enough if they hear the murmur of the mass and see the Elevation of the Host, but ours are to be fitted for auditories." This end Wren held steadily in view, and account of it must be taken in criticising his churches. The interiors are, with few exceptions, rather bald, and destitute of the mystery and play of light and shade to be found in the mediæval church; but Wren deliberately sacrificed these effects to practical considerations. He insisted that, if possible, everyone must both see and hear the preacher, and when that was provided for, he was less careful about those subtle qualities of architecture which appeal to emotions that lie less close to the surface. Wren was

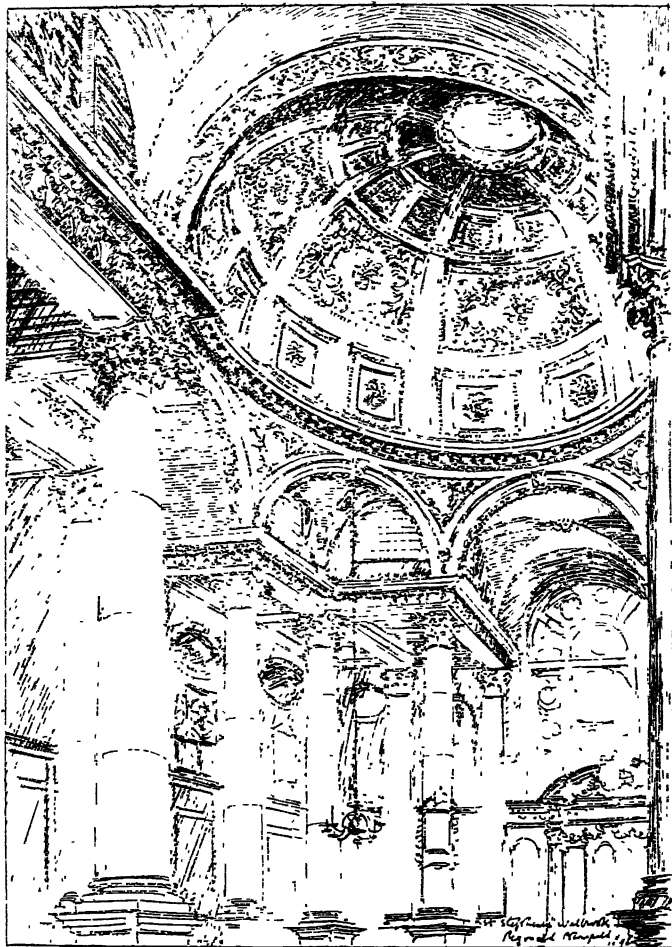

INTERIOR OF ST. STEPHEN'S, WALBROOK.

throughout his career thoroughly conscious of what he was doing, and though an architect of astonishing capacity, he possessed little of the *abandon* of the purely artistic genius. On the other hand, the strong point about these churches is their reasonableness, and their skilful adaptation of means to ends. Wren was essentially an architect, perhaps a little careless in detail, but most dexterous in emergency, and the ingenuity with which he met the difficulties of his sites has never been surpassed.

The remarkable variety of treatment shown in these churches makes them difficult to classify. An examination of Wren's designs shows that he had three ways of covering in his churches. The sites with which he had to deal were usually irregular parallelograms, varying from 60 ft. by 30 ft. (St. Basil's, Gracechurch Street) to 114 ft. by 81 ft. (Christ Church, Newgate Street). The churches built on these sites had either (1) a single flat ceiling with a deep plaster cove; or (2) domes with arched recesses, with or without detached columns; or (3) naves covered with waggon ceilings, with flat or groined ceilings to the aisles. Under the first head will also have to be classified churches of the meeting-house type, but with a single aisle, such as St. Lawrence Jewry. St. Benet's, Gracechurch Street (1685), and All Hallows, Lombard Street (1694), are good examples of the single-room type. Other instances are St. Mary Somerset, St. Nicholas Cole-Abbey, St. Michael's, Queenhithe, and St. Edmund's, Lombard Street. Of the second type of church the most familiar instance is St. Stephen's, Walbrook (1672-79), a church which has been extravagantly praised, but which is undoubtedly one of the most original of Wren's interiors. The plan consists of a parallelogram, 82 ft. 6 in. by 59 ft. 6 in., divided into five aisles of varying widths by rows of columns in six bays. The third and fourth columns from the east end in the centre aisle are omitted, leaving a square space which is covered in with a circular dome, springing from a heavy entablature on eight arches. The east bay of the centre aisle, and the two bays to the west, are groined, and the aisles have flat trabeated ceilings. The result is that, out of a rectangular room, Wren has got the effect of a church with a nave, aisles, and crossing. Mr. Fergusson has sought for the origin of this masterly conception in certain eastern domes. But Wren had certainly never seen such domes, even if he knew of their existence; and it is more probable that he

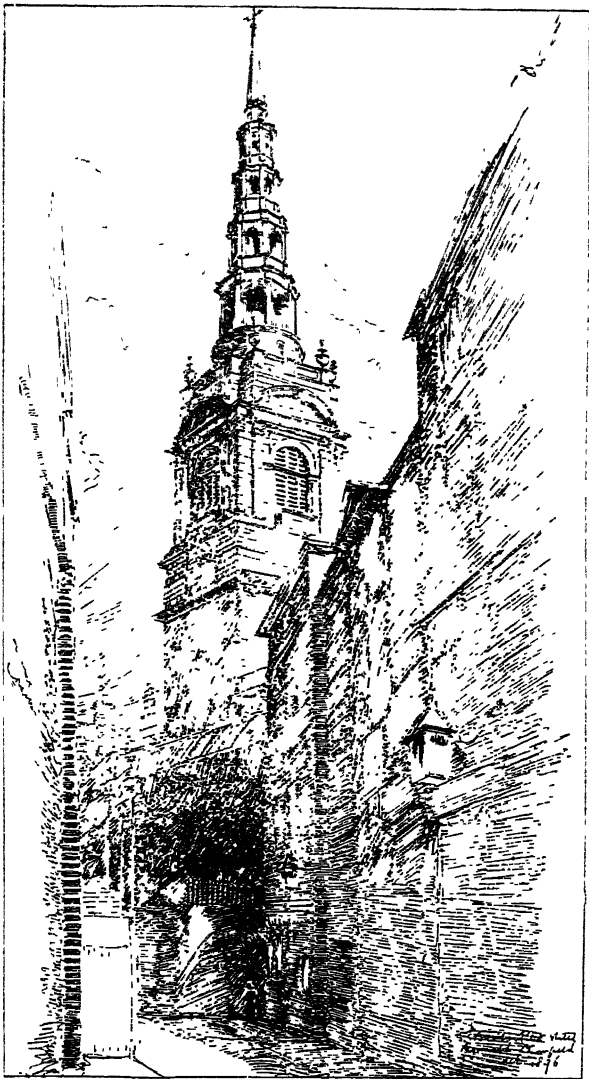

ST. BRIDE'S STEEPLE, FLEET STREET.

arrived at his result by pure ingenuity and constructive skill. In fact, the fault of the design, apart from its details, is that it leaves the intellectual scaffolding too much in evidence. The re-entering angles of the square under the dome are rather bald in treatment, and the suggestion of the constructive skeleton is unpleasant. Wren, having broken the back of the difficulty, was a little careless about its ultimate form, for the details of St. Stephen's, Walbrook, are coarse and irrelevant. But taken as a whole, St. Stephen's is a most impressive interior. It is the more interesting in that it is one of Wren's earlier works, and that in this church he made his first venture in the treatment of domes, one of the noblest expressions of architecture, and one in which he was probably more successful than any architect before or since.

Wren used cupolas at St. Antholin's, St. Mary Abchurch, St. Benet Fink, and St. Swithin's, Cannon Street, and employed a charming variation in St. Mildred's, Bread Street. The plan is a parallelogram, 62 ft. by 36 ft. Wren divided this into three parts, the centre covered by a dome the full width of the building, and the two end spaces by bold semicircular arches. His usual treatment of such a space was to form a bold cove cornice with a flat ceiling. It is probable that the success of St. Stephen's, Walbrook, tempted him to this fresh experiment at St. Mildred's. St. Stephen's was building from 1672 to 1679; and St. Mildred's, Bread Street, was built between 1677 and 1683.

For larger sites Wren generally adopted the ordinary nave and aisle treatment, usually with galleries round the west, north, and south sides. On the whole the finest examples of this class are St. Bride's, Fleet Street, and Christ Church, Newgate Street; and Wren's versatility is clearly shown in these two interiors. St. Bride's is as light and cheerful as Christ Church is austere and almost forbidding. Both churches have galleries, but the treatment is more satisfactory in Christ Church than in St. Bride's. In the latter the columns are coupled, and small pilasters at the side of the columns carry the gallery front, with the unhappy result that the columns are divided halfway up by the gallery front. At Christ Church the columns carrying the entablature, from which springs the waggon ceiling, stand on a lofty pedestal reaching up to the soffit of the gallery. The effect is to increase the apparent

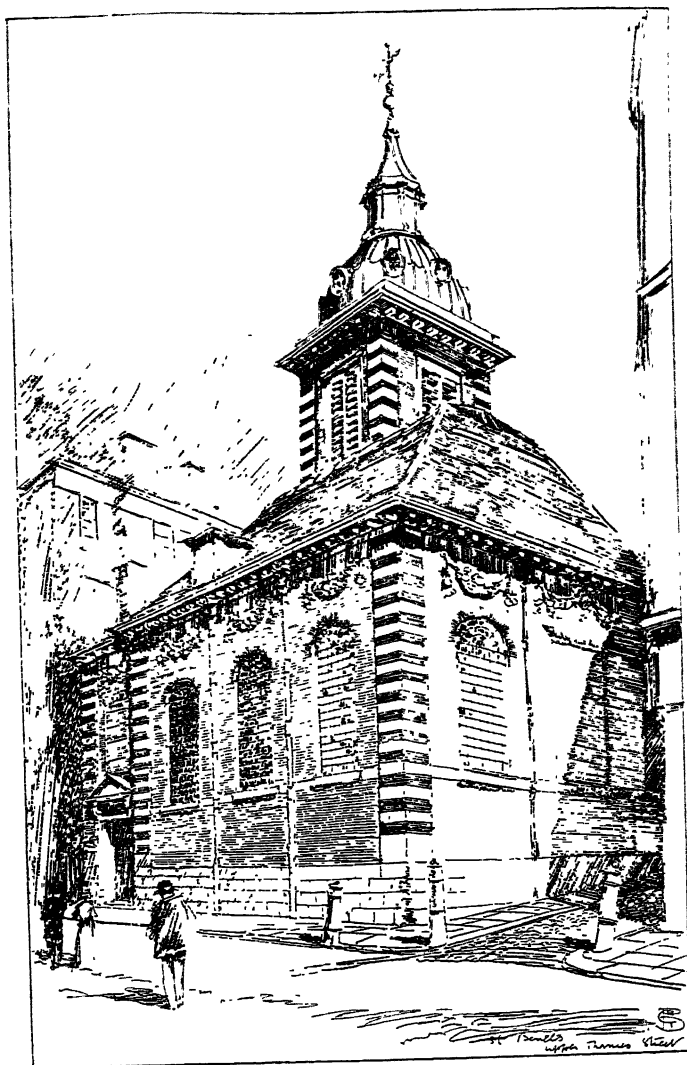

ST. BENET'S, UPPER THAMES STREET.

stability of the columns, and this impression is further heightened by the continuous entablature which they carry, instead of the detached fragments of an entablature used at St. Bride's. In St. Clement Danes (1684) solid rectangular piers support the gallery, the front of which is returned above these piers, and the Corinthian columns supporting the arcade start clear above the gallery front. The idea which Wren had in view in Christ Church is still further developed in the Church of St. Andrew by the Wardrobe. Wren was evidently striving to bind the gallery and the piers supporting the nave roof into a homogeneous composition. He failed to do so in St. Bride's (1680), and St. James's, Westminster (1683), was partially successful in Christ Church (1687), and finally realized his idea in St. Andrew by the Wardrobe (1692). In this church he again used the high pedestals up to the gallery, but instead of columns he used square panelled pillars, and dispensed with an entablature altogether. This interior is, notwithstanding, one of the least attractive of Wren's designs. A fault almost inevitable in Wren's treatment of his waggon ceilings is conspicuous in the ceiling of St. Andrew's. Wren introduced in each bay large circular wreaths of flowers on the arched soffit of the ceiling, and the conflict of the circle on plan, with the curve in section, is exceedingly unpleasant. The same fault occurs in the ceiling of St. Peter's, Cornhill. St. Andrew's, Holborn, St. Magnus, St. James's, Westminster, St. Nicholas, Cornhill, St. Mary Aldermary, St. Mary-le-Bow, are the most important examples of the waggon roof and side aisle type; but on the whole the interior of Christ Church, Newgate Street, is the best of any of the churches of this class.

Though some of his interiors are attractive, and nearly all of them reasonable, Wren's design is seen to greater advantage in the outside than in the inside of his churches. He selected the position of his towers and determined their general outline with fine judgment. He foresaw that in course of time most of his churches would be hidden away by adjacent buildings, and he accordingly concentrated his ornament on his steeples and the upper part of his towers. Here again Wren's fertility of invention is astonishing. With obvious ease, and without affectation, he varied his design for each fresh steeple, only adhering to two fundamental principles: (1) that the tower should, if possible, stand clear of the building, so

that nothing should be lost of the full effect of its height and proportions; and, (2) in view of the adjacent buildings, and also to emphasize the effect of the richer work above, he kept his lower storeys simple and almost entirely free from ornament. The tower and steeple of St. Mary-le-Bow, Cheapside, is an almost perfect example, more particularly in the nice determination of the quantities of ornament, for the curious finials which surmount the pilasters at the angles of the tower are, for their purpose, an inspiration of genius. They are just sufficiently weighty in mass and fanciful in form to effect the transition from the square tower to the circular stylobate which begins the steeple, and are happier than the urns which have to answer the purpose at St. Bride's, Fleet Street. In both these steeples Wren depended largely on the repetition of forms, adjusting their dimensions with an extremely delicate proportion. St. Mary-le-Bow is less monotonous in outline than St. Bride's, but it has the advantage of site; and at any point from which the tower and steeple of St. Bride's can be seen as a whole, the repetition of, one might almost say the insistence upon, the dark spaces of the arched openings of the steeple are entirely justified. St. Bride's is the stronger design of the two, and in its stern simplicity shows a finer quality of imagination than is generally found in Wren.

St. Mary-le-Bow was completed in 1680, whereas the steeple of St. Bride's was not built till 1701-2; and this bears out a remark made earlier in the chapter, that, as Wren advanced in experience and mastery of his art, he gradually shook off the artificial manner which he learnt in France, and returned to the purer and more strenuous architecture of Inigo Jones. The latter might have designed St. Bride's, whereas in St. Mary-le-Bow there is just the faintest reminiscence of the work of the Jacobean architects. In spite of certain details which are open to criticism, these two steeples, and the exquisitely simple steeple of St. Margaret Pattens, are of their kind the most perfect specimens of Renaissance architecture in England.

Of the smaller steeples, that of St. Martin's, Ludgate Hill, is one of the most beautiful. Though his scheme for the rebuilding of London was not realized, Wren never lost sight of his great conception of the city as a whole, and kept in full consciousness the relations of his buildings to each other.

Nowhere is this more evident than in the grouping of St. Martin's steeple with St. Paul's. Its tall slender outline, poised in the middle distance as seen from the foot of Ludgate Hill, at once throws back the tremendous mass of St. Paul's, and at the same time calls attention to its magnificent silhouette. The steeple of St. Martin's is covered with lead, a material for which Wren had a special liking, on account of its durability, and because it was produced in this country. No English architect ever more thoroughly understood his materials, in regard not only to their permanence, but also to their possibilities of colour and their decorative qualities. The contrast of lead with the silvery white of Portland stone is the most beautiful colour effect to be found in any building in London, and Wren, by preference, always employed these materials, or, if economy was necessary, he reserved his Portland stone for quoins and dressings, and used for his walls the fine old London brick, or red gauged brick work of excellent quality.

For reasons which he has not explained, Wren occasionally designed his towers in what he supposed to be the Gothic style, even when he designed the rest of the church in his habitual manner. St. Dunstan in the East (1698), St. Mary Aldermary (1711), and St. Michael, Cornhill (1721), are well-known examples. Whether Wren made these designs under pressure, or merely as academical exercises for the entertainment of his friends, is unknown; but it is evident that he had not the least sympathy with Gothic architecture, or taken any trouble to master its rudimentary features. His great architectural capacity saved him from disasters in outline and proportion, but the result is uninspired and unconvincing. Wren's addition to the gateway of Christ Church, Oxford, is perhaps the most successful instance of his Gothic. But the coarseness of its detail is out of scale with the delicate sixteenth-century work below, and here, as elsewhere, Wren seems to have paid the very scantiest attention to the nature of the older work with which he had to deal.

Meanwhile Wren had devoted his best energies to the new Cathedral of St. Paul's. The first idea had been to patch up the ruins left by the Fire, and some work was actually begun at the west end; but, as Wren foretold, it was lost labour, for in 1668 the work fell down about the workmen's ears, and Wren was summoned in haste to advise the Commissioners. He



From Buck's "City Churches."

P. 122.

ST. PAUL'S CATHEDRAL FROM THE WEST.

(BY SIR C. WREN.)

was at once instructed to clear the site of the ruins, a difficult task which he carried out with his usual address, and to prepare designs for an entirely new cathedral. Wren prepared several designs, only three of which, however, are of historical importance. The first is the famous design on which Wren had set his heart, but which was rejected owing to the obstinacy of the Duke of York, and the timidity of the clergy, who were aghast at the novelty of its plan. The second is the design which was declared in Charles's warrant to be "very artificial, proper, and useful"; the third, the design actually executed. The plan, elevation, and section of the rejected design are preserved in All Souls' Library, and the model which Wren had made of it is now in St. Paul's Cathedral. The plan, roughly speaking, consisted of a square, 300 ft. by 300 ft., with the four angles cut off on a quadrant described from the four points of the square. Over the central space there was to be a dome of 120 ft. diameter, and 180 ft. high from the floor. The north, south, and west arms of the cross were to be square in plan, and the east arm, forming the choir, was circular in plan; but the east and west ends of the circle were to be cut off, and the choir stalls were ranged on the north and south sides on the segment of a circle. A screen with a flight of five steps separated this choir from the space under the dome. An outer and inner dome over the centre is shown in the drawing, both constructed in masonry, and the whole building was to stand on a podium or platform raised some 10 ft. high above the ground level, with entrances on the north, south, and west sides approached by flights of sixteen steps. The nave was carried westward by an extension with a secondary dome, which was to have a narthex and portico at the west end with detached colonnade. Instead of the double order of the design executed, the exterior consisted of a single order on a lofty stylobate, with an attic storey over, surmounted by a balustrade. The design was in many ways an exceedingly fine one, but the plan would have been ill-suited for service, as from more than half the points of view the high altar would have been invisible; and it is probable that, seen from outside, the great central dome would have looked overpowering. Wren's idea, in the quadrant walls uniting the points of the cross, may have been to free the dome; but it is probable that he would have overreached himself in this; anyhow, in the design actually executed he did the exact opposite,

and instead of a hollow recess, put square projections at the angles with most satisfactory results.

The design accepted by the warrant of the 14th of May, 1675, was very inferior to this. In its general plan it was not so very unlike the plan actually executed, though there are many variations in detail; but its main feature was a most grotesque design for the central dome. This was to consist of a lower dome, of 112 ft. diameter, of masonry, partly covered with a lead roof, but instead of forming a complete dome, this was stopped about halfway up by a drum of 56 ft. diameter, covered in with a semicircular dome, above which rose the false outer dome terminating in a steeple in six stages, like St. Bride's. The height to the crown of the upper internal dome was to have been 215 ft., and to the top of the cross 390 ft. This extraordinary freak has been a stumbling-block to all Wren's admirers. Yet the explanation is probably nothing more than Wren's immaturity at the time that he made the design. It must be remembered that, when this design was made, Wren was still young as an architect, and by no means sure of himself. He advanced *per saltum* through the experience of actual practice, and his increasing knowledge led him to reject this design as the work went on; but he probably designed it in all good faith in the first instance, and that he did so may be taken as further evidence that the faults and inferior technique of Wren's earlier work were the result of inadequate training. It was not, in fact, till middle age that Wren shook off this amateurishness, and, in point of fact, there is little to choose between this design and the pineapple scheme which Wren suggested immediately before the Fire. In the warrant of 1675 Wren was authorized to make some variations, rather ornamental than essential, "as from time to time he should see proper." The variations actually made are so essential that it is almost impossible that Wren could have slipped them in without obtaining the consent of the Commissioners. He entirely abandoned his nightmare conception of two domes and a telescope steeple, and made a fresh design (the one actually executed), of which the most conspicuous characteristic is its magnificent sanity. In this, his final design, Wren avoided that excessive multiplication of parts which had been the weak point in all his previous attempts.

In regard to the ground-plan, Wren adhered to the general

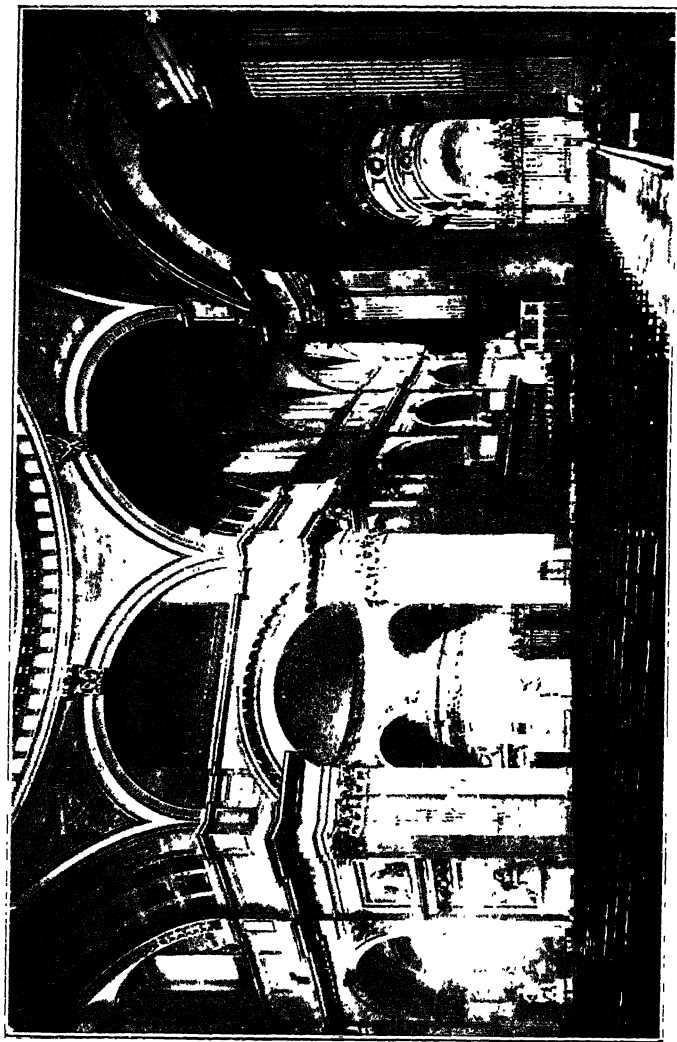

Frith & Co. photo.

ST. PAUL'S CATHEDRAL; INTERIOR.

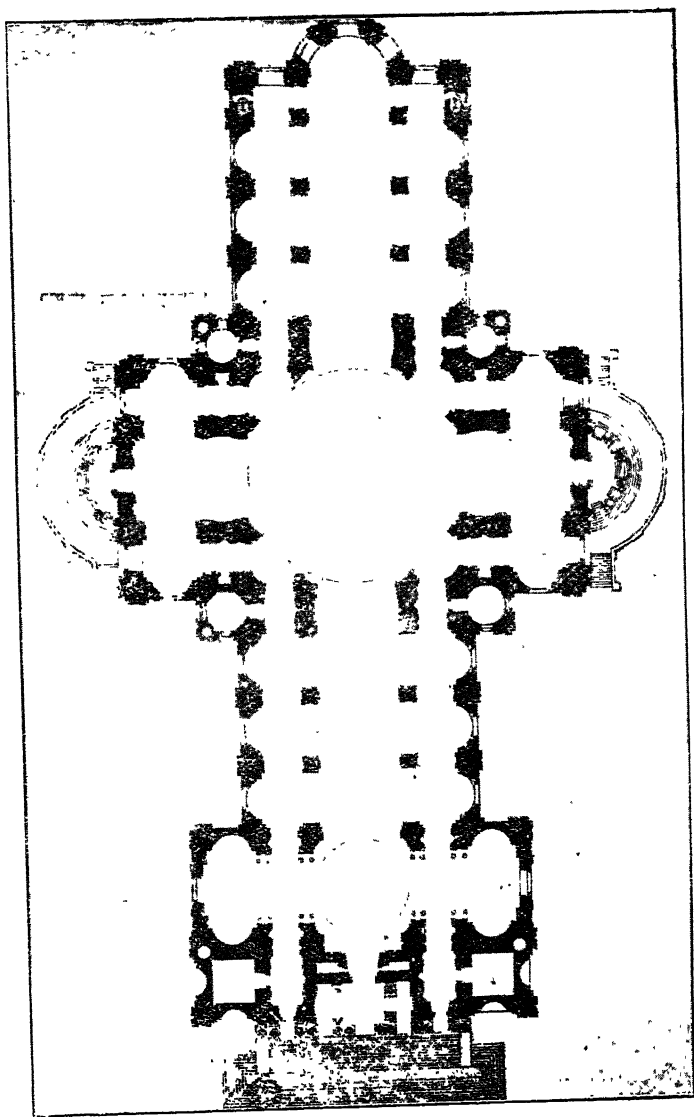

PLAN OF ST. PAUL'S, NEARLY AS EXECUTED.
All Souls' College Collection.)

conception of the warrant plan (1675), consisting of choir and aisles, transepts and nave with aisles, with a dome over the crossing, which, in its general arrangement, was based on Gothic precedent. The chief variations which he introduced as the work went on were: (1) an entirely different dome over the crossing; (2) the circular recesses to the north and south windows of the choir aisles; (3) the north and south transepts were contracted by one bay, and a circular peristyle added on north and south fronts; (4) the nave was considerably altered. In the 1675 plan the nave consisted of five bays, with a narrower bay at the west end. In the actual plan, going west from the crossing, there are three oblong bays, then a wider bay, covered in with a circular dome, with oblong chapels on either side, projecting beyond the north and south aisles. Beyond these chapels are the two west towers with the entrance ways to the aisles, and a recess behind the three centre bays of the great west portico. (5) In the warrant design the north and south walls of the nave aisles terminated in a parapet course, showing the upper walls of the nave behind them. In the actual building the north and south walls of the aisles were carried up to the full height, concealing the external upper walls of nave, and a double order was adopted, because Wren found himself unable to get stones of sufficient size for the diameter (more than 4 ft.) of the columns of a single order. Among other variations in detail, it is to be noted that, in execution, Wren largely increased the area of the detached piers under the central dome beyond what was shown in the warrant plan. He was evidently anxious about the tremendous weight and thrust of his dome, and as an additional precaution he built round the base of the inner brick cone, which he constructed to carry the Portland stone lantern, a course of large Portland stones, in which was embedded a massive iron chain.

St. Paul's as actually executed was, in fact, the result of many experiments. The one fundamental idea with which Wren started was the great central dome, and from the very first, as early as 1666, Wren hit on the happy constructional expedient of an outer and inner dome, the only possible solution to the problem of making a dome beautiful both from within and without. Starting with this, and restrained at once by his own practical sense and the incessant limitations imposed on him by the Commissioners, Wren gradually worked

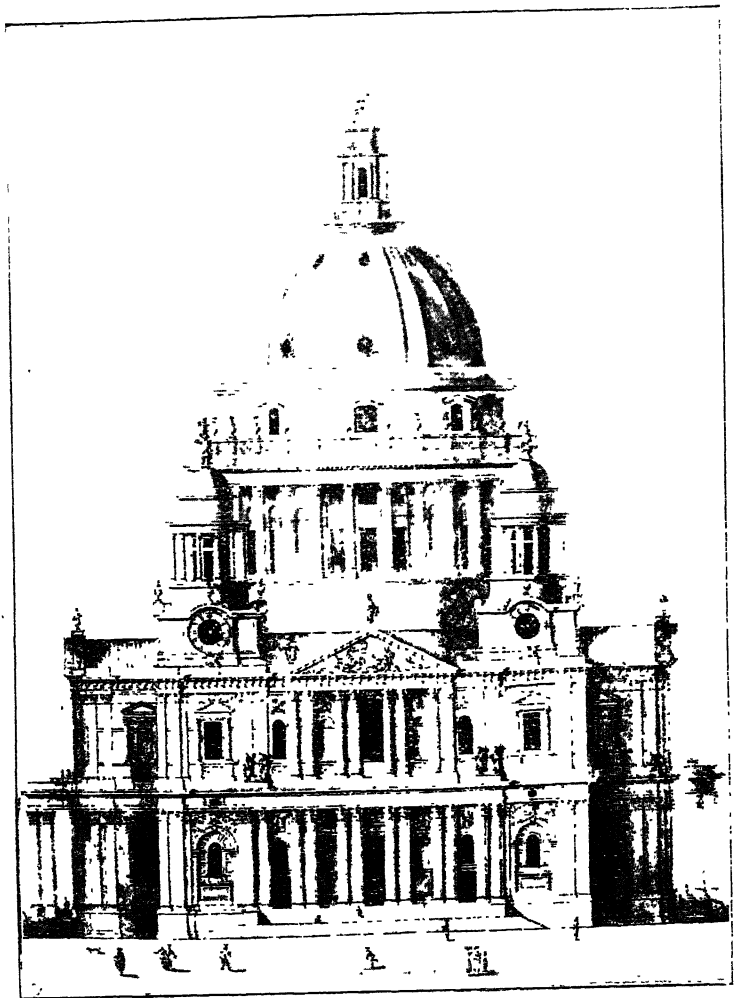

ST. PAUL'S, NEARLY AS EXECUTED. A DRAWING BY WREN.
(All Souls' College Collection.)

out the present superb design ; and it is interesting to notice how again and again he went back on his own ideas. The second internal dome at the west end is a reminiscence of the west extension of the nave of his rejected plan. So, again, there is a drawing at All Souls' (No. 39, vol. ii.) showing the treatment of the dome. In this drawing only eight lights are shown in the drum, and the dome is divided by eight external ribs, with small lucarnes in each bay of the dome. In the dome as executed all the windows are kept below the springing, and there are no lucarnes to intercept the grand outlines of the dome. In spite of Wren's own predilections for his rejected design, one cannot escape the impression that the design actually executed is far better than any of those shown in his previous drawings. Wren, like all great architects, had an extraordinary aptitude for bringing his work along in the actual process of building. He was a poor draughtsman, and he was the last man in the world to be deceived by his own drawings ; and there can be no doubt that the superiority of the actual building to any of the designs on paper was due to Wren's constant care and minute supervision of detail. Leaving St. Peter's out of account, as differing both in scale and intention, the result is unquestionably the finest church in Europe produced by any architect of the Renaissance. Various criticisms have been made on St. Paul's, more particularly on the internal and external domes, and on the screen walls of the north and south aisles. In regard to the first, as has been mentioned already, there is absolutely no other way of forming a dome which shall be satisfactory both inside and outside. If the outer dome were taken, its effect from inside would be that of a chimney, and if the inside dome were taken, its external outline would be little more than a hump over the centre of the building. The brick cone which supports the lantern and cupola is an extremely skilful expedient, and an architect is not bound to show every detail of his construction, however ugly it may be. The ultimate justification of architecture is that it should be stable and beautiful. It is in the architect's discretion to choose his means of impressing the imagination, and, provided he attains his result, he is not to be bound by pedantic criticism as to his means—criticism which assumes an intention which never existed in the architect's mind. The objection to the screen walls raises a more difficult question. These walls conceal the

actual construction of the nave and aisles, and with less justification, inasmuch as there was no inherent objection to showing the general constructional intention, as there certainly was in the case of the double dome. Wren, however, conceived of his problem differently, and certainly succeeded within the limits that he set himself.

The first stone of St. Paul's was laid in 1675 by Henchman, Bishop of London, who died the same year. The Strongs, father and son, were the chief masons, Richard Jennings the chief carpenter, the wood-carving was by Grinling Gibbons and his assistants, and Caius Cibber and Thomas Bird did the external figure-carving. The last stone to the top of the lantern was laid by Wren's son in 1710. Godwin and Britton state that the total cost was £747,954 2s. 9d., but this figure is very much below the mark, and does not include the cost of Thornhill's painting, which was paid for at the cost of 40s. a square yard. In the exquisite ironwork of the screens Wren employed Tijou, a French smith of unsurpassed ability, who designed the beautiful gates of Hampton Court, since removed to South Kensington.

Wren's career was one of incessant labour. Besides St. Paul's, and the fifty-three City churches built between 1670 and 1711, Wren designed three palaces, two hospitals, and a vast quantity of less important work, and in his capacity of Surveyor-General had to deal with constantly recurring questions of alignment of sites, and compensations, and compliance with such building regulations as were then in force. Miss Phillimore and Elmes assign to him the design of some thirty-seven of the City halls built between 1666 and about 1700. There is no mention of these in the list of Wren's works, drawn up by his son and collated by Wren in 1720, though the City churches are mentioned generally; and it is probable that several of these halls were designed by Mills, the City Surveyor, and by Edward Jarman (who also designed the new Exchange), though the designs were doubtless submitted to Wren for his approval. In 1671 Wren designed the Monument, by no means a masterpiece, and Temple Bar. From 1674 to 1684 he was engaged in rebuilding the greater part of the Temple. The work is quite plain, only enriched with quoins and well-proportioned cornices, and a few charming doorways; and Wren reserved his ornament for the chief entrance in Fleet Street, completed in 1684, of Portland stone and gauged brick. Its fine proportion and colour make

this design one of the most beautiful instances of Wren's domestic work in London. The entrance to Christ's Hospital, built in 1682, is another good example of his treatment of gabled brick.

In 1678 Wren prepared designs for a mausoleum to Charles I. The drawings, now at All Souls', show a dome of 60 ft. diameter, with a total height of 90 ft. from the floor, within which was to stand a large allegorical group of Charles I. and other figures in bronze and marble. The top was to be surmounted by a bronze figure, 10 ft. high. Wren intended to ornament the interior with bronze, marble and mosaics, and to inlay the pilasters with "incrustations with various marbles," and estimated the total cost at £43,663 *2s. od.* Seventy thousand pounds was voted by Parliament for its execution, but this money was taken by the king for his private purposes, and the scheme was quietly dropped. In the same year Wren designed the Library of Trinity College, Cambridge, and in 1682, the Library of Queen's College, Oxford, a reminiscence of the Trinity Library, but on a smaller scale.

Wren was evidently very much taken with the idea of square, octagon, or circular buildings, covered in with domes. His first design for the Library of Trinity, Cambridge, consisted of a circular building of 65 ft. diameter, and 90 ft. high from the floor to the crown of the dome, pretty nearly the dimensions of the mausoleum design. This design was rejected in favour of the design actually executed, which consists of a magnificent room, 150 ft. long by 38 ft. wide inside, with cloisters underneath.

Wren's next important building was the Royal Palace at Winchester, begun in 1683, since turned into barracks, and so altered as to convey little idea of Wren's original intention; and to this date belong the episcopal palace of Wolvesey at Winchester, rebuilt by Morley in 1684, and the schoolroom at the College, 1684-87. The Royal Palace at Winchester was intended to rival Versailles, but the king's death suspended the works, and the scheme was never completed. The point of interest in Wren's design is the large scope of his conception. Wren had intended to carry a broad street in a direct line from the east front of the palace to the west front of the cathedral; he would thus have brought the two great buildings of the city into direct relation, and made one of those superb vistas such as he had proposed in vain for the rebuilding of London, and afterwards suggested at Hampton Court.

The special strength of Wren's genius lay in this largeness of idea, in this power of conceiving a great architectural scheme as a whole, of grasping it in complete perspective, and keeping his purpose proof against all the temptations of unnecessary

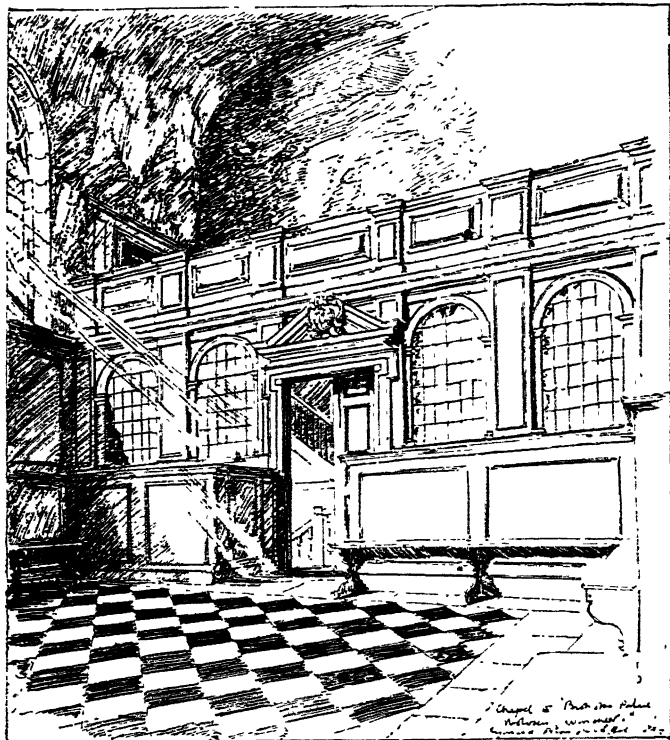

CHAPEL OF WOLFESEY PALACE, WINCHESTER.

detail. Wren was a true child of the Renaissance in this, fairly claiming kinship with Bramante and Michael Angelo, with the French architects of Louis Quatorze, and with his great forerunner, Inigo Jones. The inevitable result of the Renaissance has been that the individual idea has taken the place of the

collectivist. Whereas generations of mediæval craftsmen could go on building a great cathedral without material check or abrupt transition, since the days of the Renaissance a great work has had to be the conception of a single mind, clearly foreseen from the first, and dependent for its full realization on the permanence of its initial impulse. In this regard Wren was a master among architects. The details of his work, his actual methods of expression, are sometimes open to criticism; but for range of idea and comprehensiveness of view he stands unrivalled. In the vestry of St. Paul's there is a design by Wren showing his idea for the right setting of his cathedral. He proposed to surround it by an arcade, leaving a free space round the cathedral, wider at the east end and drawing in towards Ludgate Hill; at some distance from the west end, but on its axis line, was to be a baptistery. This design was never carried further. So again at Hampton Court, Wren's addition, noble as it is, was only a fragment of his complete design. Besides the court actually built at the south-east corner, Wren proposed and designed a magnificent forecourt, 300 ft. long and 230 ft. wide, on the north side of Hampton Court. The great hall was to be the centre, with a double flight of stairs to the entrance. The east and west sides of the court were to consist of buildings with an open colonnade to the court. From the entrance to the forecourt a straight road was to be drawn across the moat and through the wilderness, connecting the forecourt with the great Chestnut Avenue of Bushey Park, which was to be a mile long and sixty yards wide. The avenue, which was planted about 1700, was the only part of this gigantic scheme which was ever attempted, and this was carried out, not from Wren's but from Talman's designs.

Wren's work at Hampton Court was begun in 1689, and the decorations were not completed in 1700. He again employed Gibbons and Cibber for the carving, and Tijou for the smith's work. The building is of red brick and Portland stone, simple in composition and beautiful in colour. In spite of the jealousy of Talman, and the extreme obstinacy of William, Wren was completely successful with his design, except in one or two points of detail, such as the segmental arches in the tympana of the arches to the cloister arcade, and even here it is stated in the "Parentalia" that this was done by his majesty's express order. About the same time Wren made considerable

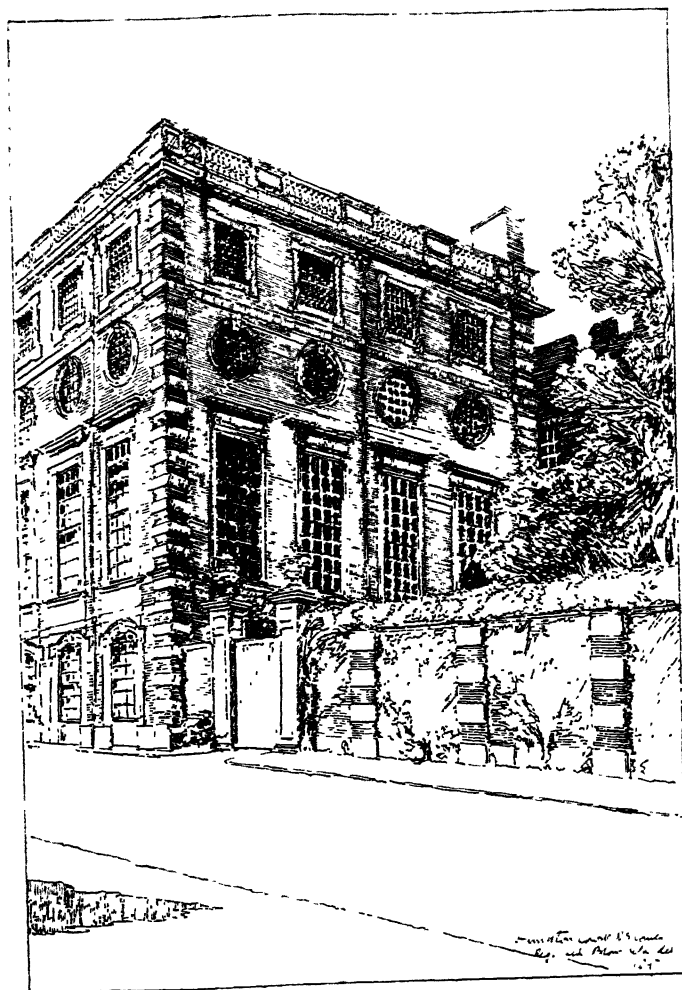

HAMPTON COURT, NORTH-EAST CORNER.

additions and alterations to Kensington Palace, including probably the orangery. The building is very plain, but characterized by the solidity of taste and entire reasonableness which mark all Wren's later work. Chelsea Hospital, 1682-92, is another fine example. Wren's masterpiece, however, in public buildings, is Greenwich Hospital. When Wren began this work there were two buildings on the spot: (1) the house facing the park, designed by Inigo Jones for Henrietta Maria, and built under his superintendence with the assistance of John Webb; and (2) the unfinished palace, begun by John Webb, from designs by Inigo Jones, for Charles II. This building forms the left-hand or western block, facing the river; it was already partially completed, and probably Wren only added the entablature and the attic storey. Wren's ultimate object was to include both the existing buildings as part of his general scheme; he made the Queen's Palace of Inigo Jones the centre at the extreme end on the landward side, and starting from this point he designed two courts with colonnades facing each other, and running northwards towards the river till they joined the great court, the west side of which was already occupied by King Charles's block. The junction with the great court is marked by two domes, surmounting the entrances to the chapel on the east side and the hall on the west. The court to the south of the hall and west of the colonnade is called King William's block, the court to the south of chapel and east of colonnade Queen Mary's block, and the block begun by Wren on the river front, ranging with King Charles's block, is called Queen Anne's block.

Wren thus brought his buildings up to Charles II.'s palace, which was already *in situ* facing the river on the west or upper side, going up stream. Opposite this palace he now built another block, in exact imitation of the original design of Inigo Jones, which was completed in 1715, and named after Queen Anne. In this masterly manner he succeeded in working in the old buildings, and in planning at the same time the noblest palace in England. Along the east and west fronts of King William and Queen Mary's blocks, and facing each other on either side of the space leading up to the Queen's House, Wren built a colonnade of pairs of Tuscan columns on detached blocks, supporting an entablature and balustrade; at the north or river ends of these blocks come the domes. Seen from close

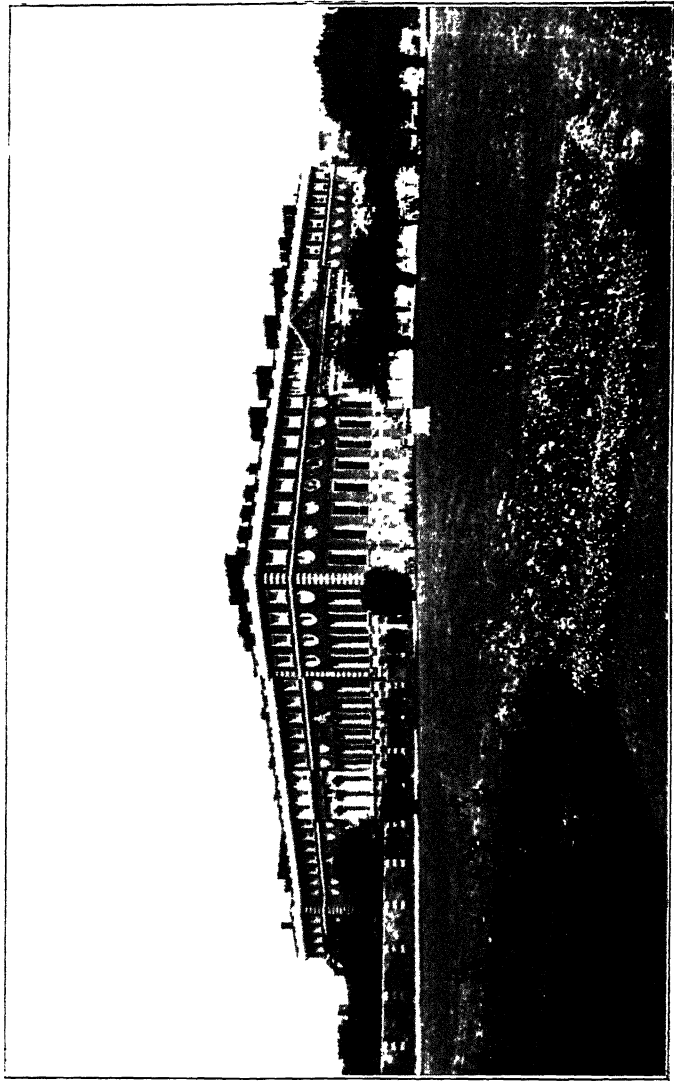

W. Spooner & Co. photo.

HAMPTON COURT.

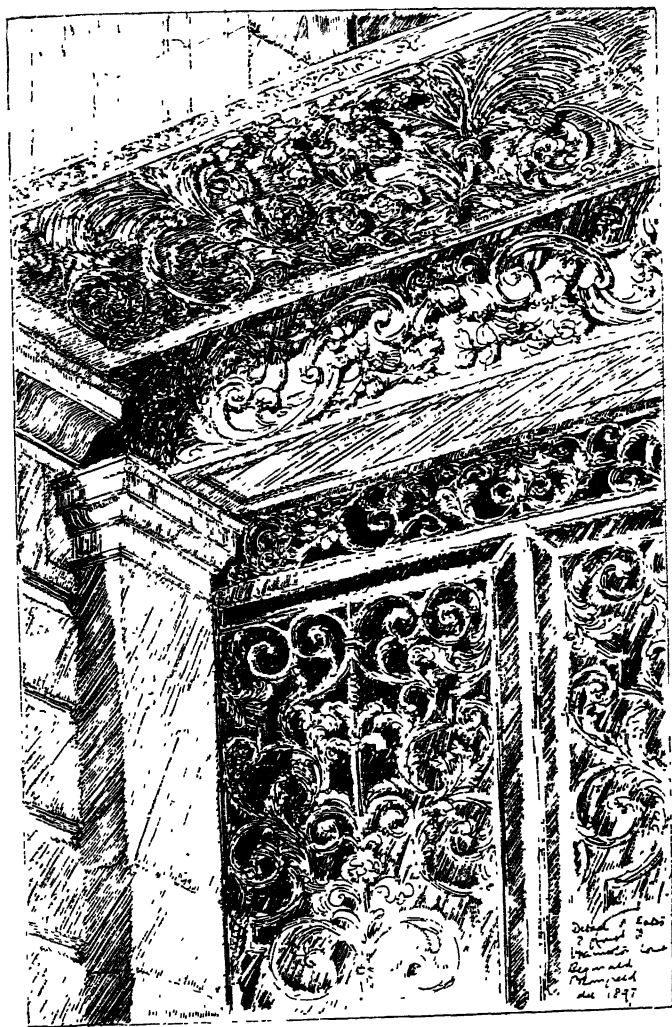

HAMPTON COURT, DETAIL OF GATES.

at hand, the domes are disappointing, and the outline is a little too precipitous; but at any distance, the grouping of these domes with the general composition is superb.

Thus the general design and arrangement of the building was due to the genius of Wren. He was, however, ultimately superseded by Vanbrugh and others, and it is not always easy to disentangle the additions by other hands. In 1696 the river side of the north-west, or King Charles's block, was already completed, with probably part of the remaining three sides to this block. Wren's work consisted of the river front of the north-east or Queen Anne's block, the north and south sides of King William and Queen Mary's blocks, including the hall and chapel, the return angles of the west side of King William's Court (date on rain-water heads, 1706), the colonnades, and the two domes. In this work he was assisted by Hawksmoor, who was appointed clerk of the works in 1698 and deputy-surveyor in 1705, and who seems to have been allowed to design part of the work himself, such as the east front of Queen Anne's block, and probably the interior of this court as well. The point of junction between Wren's work and Hawksmoor's can be seen in the re-entering angle on the east side. It is also probable that Hawksmoor is responsible for the sides of the colonnades facing the courts with square rusticated piers, the great flat pediments over the five centre bays, and the bell turrets, which are hardly in Wren's manner. Wren was superseded as surveyor in 1716 by Vanbrugh, who added the west front of King William's block and the projecting centre bay on the east side (the side to the court). On Vanbrugh's death, in 1726, Campbell was appointed surveyor, and to Campbell is probably due the south sides of King Charles and Queen Anne's blocks, the Venetian windows to these façades, and the exaggerated severity of the wide, bare wall spaces, introducing an element quite foreign to Wren's design. In 1729 Campbell was superseded by Ripley, to whom may be attributed the extremely ugly west front of Queen Mary's block. It partly recalls the baldness of the worst parts of the Horse Guards': and Ripley was on familiar terms with Kent. Ripley prepared a report on the state of the building up to date, with plans and estimates for its completion, from which it appears that up to September, 1727, £210,761 13s., and a further sum of £41,864 13s. had been expended on the building, and the

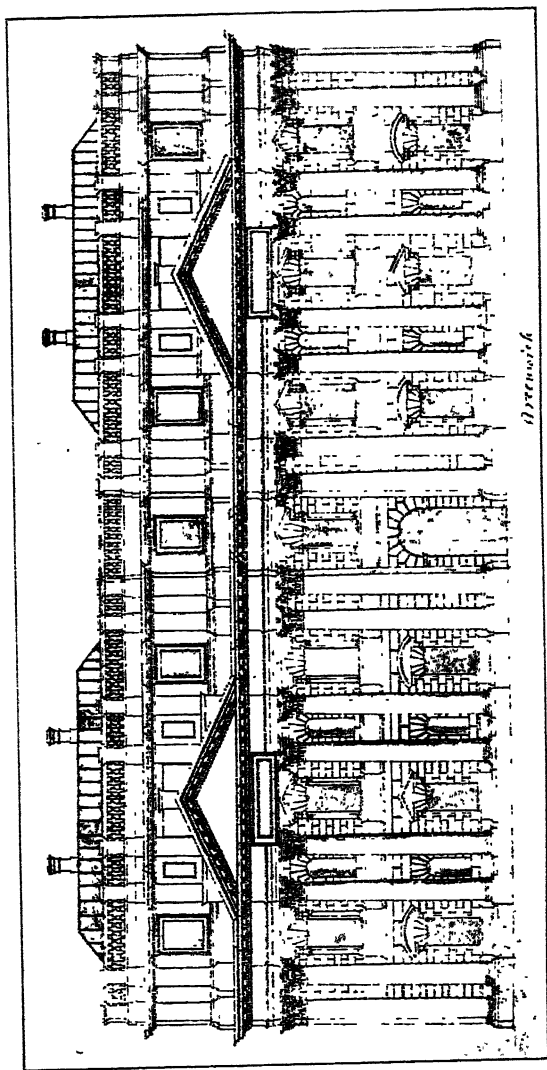

AN ELEVATION OF GREENWICH HOSPITAL.
(Soane Collection.)

estimate for completion was £131,750. On March 6th, 1734, a plan was laid before the House of Commons, showing the building complete, but with Queen Mary's court not yet built. Ripley's estimate for this was £80,444 16s., and he appears to have carried out the work soon afterwards. Finally, in 1814, the west front of King Charles's block was completed for George III. by Stuart, who in rebuilding the chapel introduced his own exceedingly barren ideas of design into the interior.

In the collection in All Souls' Library there are several plans for large houses, including a large sketch design for a house for the Duke of Norfolk, on the site of old Arundel House in the Strand, which was destroyed in 1678. Marlborough House, built for the Duke of Marlborough in 1709, since altered by the addition of a storey, is a well-known instance of Wren's domestic work. The All Souls' Collection also contains the plans of some new barracks for Hyde Park, of a total area of 1,590 ft. by 430 ft., which were never carried out. Of Wren's smaller buildings, Morden College, Blackheath, 1694, probably Groombridge in Kent, and the house in West Street, Chichester, are good examples. It is not known that Wren had anything to do with Emmanuel Hospital, or the Trinity Almshouses, and it is not necessary to assign directly to his design all the charming brick and stone houses built between the Restoration and 1700; such, for instance, as the beautiful interior of the house at Eltham, now used as a club-house by the Eltham Golf Club, or the dainty little school-house in the Close at Salisbury. On the other hand, it would be idle to attribute buildings at once so simple, lovable, and dignified, to academical designers such as Talman or Hawksmoor, and if not by Wren, they were certainly inspired by his work.

The end of Wren's splendid career was clouded by the intrigues and jealousy of inferior men. George I., from whom he had hoped much, turned out to be stupid and unintelligent, and the German *clique* at Court had no sympathy with the man who, alone among his contemporaries, represented the noblest tradition of English art. In 1717 the Commissioners for St. Paul's insisted on the balustrade above the entablature, in spite of Wren's protest, and in 1718 a complaint of mismanagement was preferred against him by Colin Campbell and a person named Benson, and Wren was dismissed from the post of surveyor-general, which he had held for fifty years, in favour

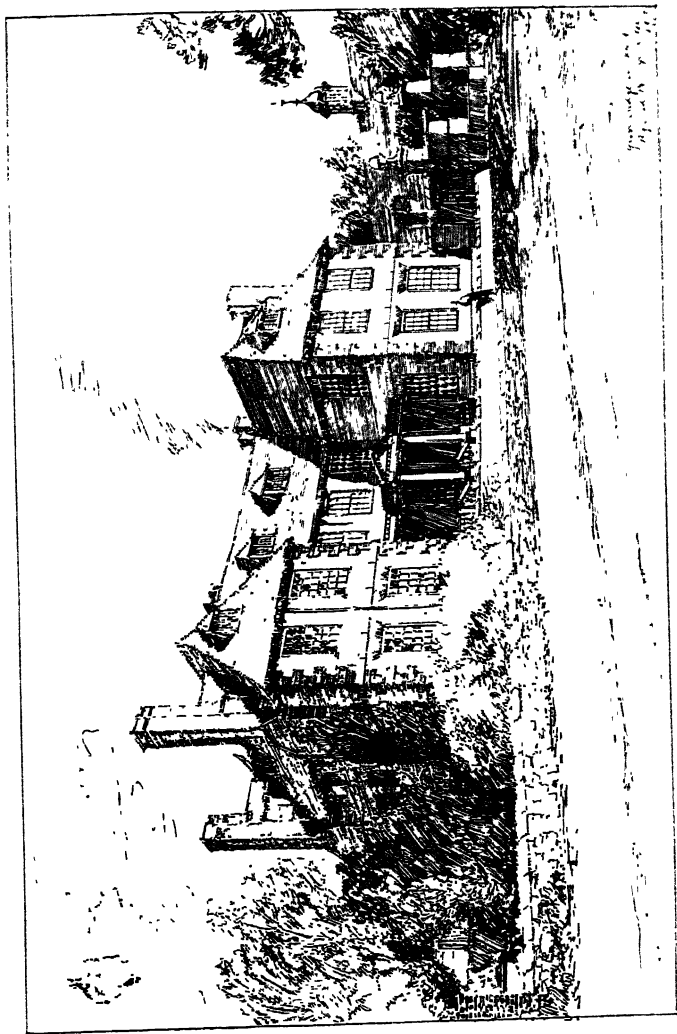

GROOMBRIDGE PLACE, KENT.

of Benson's brother, an entirely incompetent and unscrupulous adventurer. The complaint was sent by the Lords of the Treasury to Wren to report upon. He replied that the charges were groundless, and that as he was only one member of the board, he referred them for fuller explanations to the other members. Wren's closing words are pathetic: "As I am dismissed, having worn out by God's mercy a long life in the Royal service, and having made some figure in the world, I hope it will be allowed me to die in peace." He spent the few remaining years of his

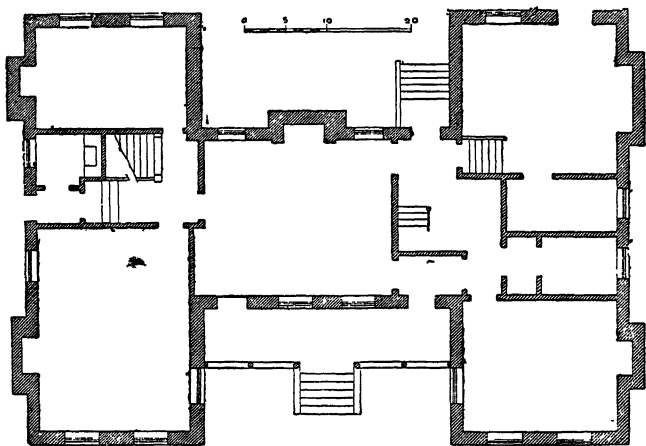

PLAN OF GROOMBRIDGE PLACE, KENT.

life in quiet at his house near Hampton Court, and died on February 25th, 1723.

By unwearied labour and indomitable effort after a high ideal, Wren had grown to be an artist of first-rate genius, superior in skill and imagination to any architect of his time in Europe. He began almost as an amateur, rich in friends and opportunity, and buoyed up by the confidence of his brilliant career at Oxford and his own extraordinary inventiveness. As yet he was ignorant of the technique of his art, and the results were seen in artistic fiascoes, such as the Sheldonian. But Wren was a man who picked up knowledge on every hand, and he was rarely fortunate in his school, for he was allowed to

learn his art on the scaffolding of his own buildings, and so gained a practical mastery of planning and construction never since equalled. Moreover, Wren's own instincts led him this way. From the very first he was an inventor—keen, alert, and

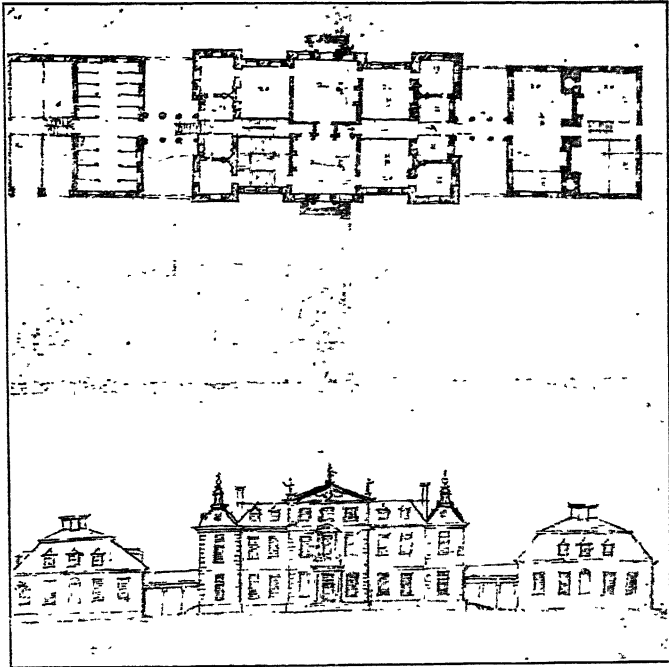

PLAN AND ELEVATION IN WREN'S DRAWINGS.

(All Souls' College Collection.)

quick to make immediate use of actual observation and discovery; he had none of the dreamer's disease of inactivity; he seems indeed to have possessed a fertility of invention which sometimes tempted him to turn out work before it was mature, and to shirk the labour of fastidious finish inevitable to the scholar and the artist. For in fact Wren's taste was always a

little uncertain. His taste, however, acquired a firmer fibre as he gained in experience ; and the distance that separates such work as St. Paul's and Greenwich from his early designs is one of the most remarkable features of his development. Wren's strong practical sense saved him from the absurdities of his successors. His work in its main features was sane and reasonable, and this not from lack of ideas, but from a clear insight into the limits and intention of architecture. Where he had the opportunity, Wren designed with a largeness of conception rare among English architects. His schemes for Winchester and Hampton Court, and his magnificent achievements at Greenwich, are at the highest level of architecture ever attained in this country. His earlier work was influenced in detail by French contemporary architecture, yet Wren maintained his individuality throughout, and one finds in his later manner a singularly direct and unaffected method of expression, free from pedantry and foolishness, and, above all, pre-eminently English in its sober power. The men who succeeded him were undoubtedly able, but they lacked the warm humanity of Wren. Their work was not spontaneous, and their inferiority appears in their conscious effort after academical correctness and their attempts to systematize architecture into a mere grammar of ornament. They sheltered their weakness under the genius of Inigo Jones, but in spite of their laborious imitation, Wren was the true successor of that great architect in all that makes architecture vital, in all the qualities that gave to the English Renaissance its sterling masculine character.

CHAPTER VIII

WREN'S CONTEMPORARIES AND SUCCESSORS : JARMAN, WYNNE,
BELL OF LYNN, TALMAN, VANBRUGH, HAWKSMOOR,
ALDRICH, CLARKE, BURROUGH, ESSEX

IN spite of the generally brilliant success of Wren's career, and the wide influence he exerted over the vernacular architecture of his time, he cannot be said to have had an immediate following either among his contemporaries or successors. Gibbs imitated him in his churches, but Hawksmoor followed Vanbrugh rather than Wren. Campbell sneered in his spiteful way at Wren's disregard of orthodox rules; Wynne had a manner of his own; and Talman, the only architect who was strictly Wren's contemporary, was his rival throughout, and never lost a chance of putting difficulties in his way. Before his death, in fact, there was a definite reaction against his manner, and a successful attempt was made to reintroduce the rigorous standard of Palladio by direct and almost servile imitation of his work. When the first volume of Campbell's "Vitruvius Britannicus" was published in 1715, this reaction had established itself all along the line.

Of the earlier architects of the Restoration very little is known. Edward Jerman (or Jarman) was architect of the new Royal Exchange, built on the site of Gresham's building, and completed in 1669. Jerman is said to have designed Merchant Taylors' Hall (since altered), Fishmongers' Hall (rebuilt 1831), Drapers' Hall (not the front), and Haberdashers' Hall. He was surveyor to Gresham College, and, after the Great Fire, was invited to report on the rebuilding of the Exchange, together with Mr. Horne, and Mr. Mills, the City surveyor; and his plan was adopted by the Committee on the ground "of the great burthen of businesse lying upon him (Mr. Mills) for the City at this time, and considering that Mr. Jerman is the most

able knowne artist (besides him) that the City now hath." In his design for the Exchange Jerman followed the old courtyard plan of Gresham's building, with a covered walk, and arcades on the sides to the court. The court was entered by a lofty arch, flanked by engaged Corinthian columns with segmental pediments. Above the arch was a tower in three storeys with a kind of Gothic tracery to the windows, surmounted by Gresham's grasshopper. The details throughout were crude, and show but a faint acquaintance with the methods of classical architecture. No other work of Jerman's is known.

The work of "the ingenious and learned Captain Wynne," so far as it is known, is at a much higher level than Jerman's. Captain Wm. Wynne, or Winde, is said by Walpole to have been born at Bergen-op-Zoom, and to have been the pupil of Balthazar Gerbier. His chief works were alterations to Coomb Abbey, Hampstead Marshall for Lord Craven, Newcastle House in Lincoln's Inn Fields, old Cliefden House and old Buckingham House in St. James's Park. Hampstead Marshall was begun in 1662, according to Walpole, on the site of the older house. There is a view of it in Kyp's "Britannia Illustrata," made before 1709, which shows a large rectangular house of three storeys and an attic, ranged round three sides of a court, with the stables at the back, and the pleasure gardens on the south side. The house was burnt to the ground in 1718, and all that remains are a walled-in garden, seven acres in extent, with a raised terrace, and eight sets of entrance piers, four of gauged brick and stone, and the rest entirely of stone. These piers are among the finest of their kind in England. The brick piers have niches and large stone urns, the stone piers have richly carved panels in high relief, very much undercut. In places the foliage is pierced, and partly detached from the stone, and French influence is evident throughout the work. Wynne was evidently an accomplished artist, and this impression is confirmed by the engravings of his designs of Buckingham House and Cliefden House. Old Buckingham House was remarkable as one of the earliest instances of the plan afterwards used so frequently by the eighteenth-century architects, of a large rectangular central block, connected by quadrant colonnades with detached sets of offices, treated as pavilions in advance of the main building, and forming three sides of the forecourt. The façade of the centre block at Buckingham

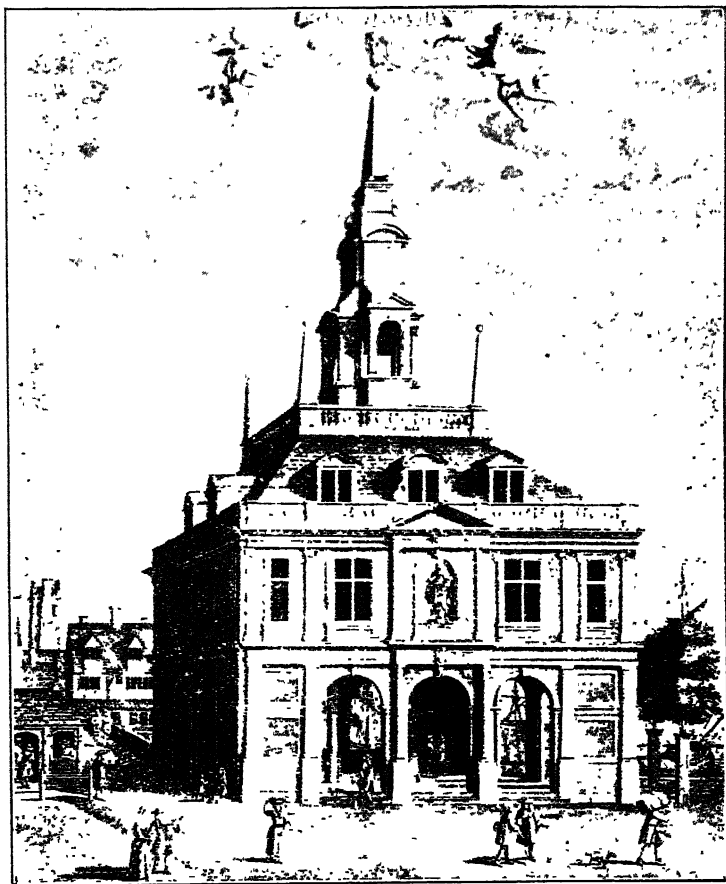

THE CUSTOM HOUSE, KING'S LYNN.
(From an Engraving by the Designer, H. Bell.)

House was more sumptuous, but hardly so attractive as the elevation of Cliefden House, which was begun by Wynne and completed by Archer, who added the two-storey offices on the north side. Of his simpler work, Newcastle House, designed for Lord Powis about 1668, is a good example. Wynne appears to have died early in the eighteenth century. Walpole says that his drawings for Hampstead Marshall and Coomb Abbey were dated from 1663 to 1695, and the date given by Campbell for Buckingham House is 1705.

Henry Bell, the architect of the Custom House and of other buildings in King's Lynn and the neighbourhood, is another architect who, in spite of his ability, is almost unknown. It appears from an inscription on a stone which used to lie in the north aisle of old St. Margaret's Church at King's Lynn that Bell was born in 1653, was twice mayor of Lynn, and died in 1717. Bell seems to have been a man of unusual capacity. He was trained as an engraver, and executed various topographical prints of Lynn, and it was probably his skill in draughtsmanship that led him to undertake design, for there is no evidence that he had any specific training in architecture. His first building seems to have been the Custom House, built as an exchange, at the cost of John Turner, in 1681. This admirable little building originally consisted of an open Loggia, about 40 ft. by 32 ft. outside, with four columns down the centre, supporting the first floor, and an attic storey above. The walls are of Portland stone, with a Doric order to the ground storey supporting an Ionic order to the first floor. The cornice is of wood, and above this is a steep pitched tile roof with dormers, surmounted by a balustrade, inclosing a flat, from which rises a picturesque wooden cupola. The details are refined, and the technical knowledge and delicate sense of scale and proportion shown in this building are surprising in a designer who was under thirty, and is not known to have done any previous work.

It is probable that Bell's next important building was the Duke's Head Inn in Tuesday Market-place, which was built before 1689, and the fine house in Queen Street with the twisted Corinthian columns to the entrance, dated 1708, is also attributed to Bell. His next authentic work was the old market cross, 1707-10, described as "an octagon surmounted by a dome and cupola. On the four sides which had not

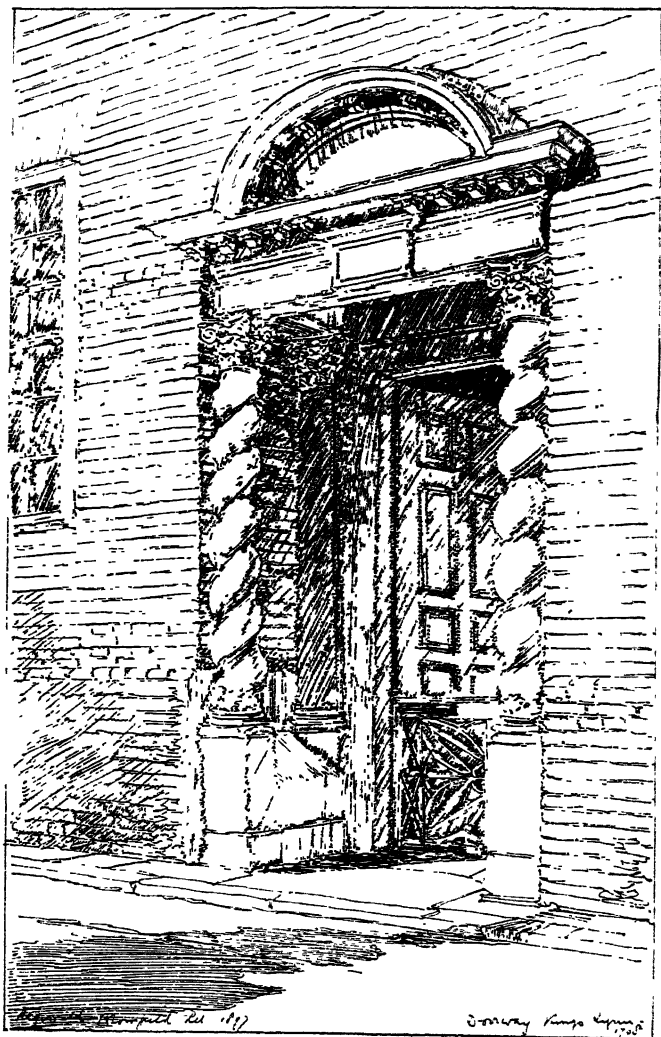

A DOORWAY IN QUEEN STREET, KING'S LYNN.

windows were statues, and a balcony went round it supported by pillars." This building was pulled down in 1831, and sold for old materials; and two other known works by Bell, the altar-piece of St. Margaret's Church, 1684, and that of St. Nicholas' Chapel, at King's Lynn, were destroyed in the restorations of these churches. The only other recorded design by Bell is North Runcton Church, about three miles out of Lynn. The tower of the old church fell in on August 15th, 1701, and destroyed the greater part of the church. Bell was called on to design the new church, which was more or less completed by about 1713. The church consists of a nave, chancel, and organ chamber, with a tower at the west end, and its most interesting feature is the simple and effective treatment of the interior. The nave is square, measuring internally 30 ft. 6 in. by 30 ft. 6 in. Within this space are four columns of the Ionic order on high pedestals supporting lintels, which divide the ceiling into eight flat panels round the sides, while the large central space is covered in with a dome, square on plan, formed by two intersecting semicircular vaults. The church had originally galleries, and has been a good deal injured by injudicious restoration, but it is still a remarkable instance of an eighteenth-century village church, designed in the simplest possible manner. No other work of Bell's is known. His few undoubted designs show a distinct and charming manner of his own, and make it the more to be regretted that such scanty record remains of this modest and very able artist.

The reputation indeed of architects is not always in proportion to their abilities. William Talman, for example, is best known as the architect of Chatsworth (1681), which, says Campbell, "for the quality of materials, neatness of execution, rich furniture, and all proper decorations, is second to none in the kingdom, and perhaps in Europe." Campbell's faint praise is in this case justified. Talman, in fact, had no nice perception of scale, or refinement of handling, and these defects appear in the elevation of Thoresby House, since destroyed, which was built in 1671. The plan of this house appears to have been chiefly taken up with halls and staircases. Walpole also attributes to Talman Swallowfield in Berkshire and Dynham House in Gloucestershire (1698). When William III. began his alterations at Hampton Court, Talman was appointed

comptroller of the works, a position quite independent of Wren as surveyor, and apparently superior. In this capacity Talman thwarted Wren at every point, and his intrigues were so far successful that in 1699 Talman designed various works, amounting to £5,514, at Hampton Court, and got into his own hands the execution of the costly works in Bushey Park and the Gardens. Talman probably died before 1715. His work has the technical ability found in the work of nearly every known English architect of the Restoration, and onwards till the latter part of the eighteenth century; that is to say, his design is fairly correct, according to the accepted canons of classical architecture, and his construction is sound though by no means dexterous. But his work is dull; what individuality there is in it is ungracious, unattractive, and limited; there is little trace in it of fine imagination, or even of that wild ambition which gives a morbid interest to the works of Vanbrugh and Hawksmoor.

These two men were almost exact contemporaries. Nicholas Hawksmoor was slightly the older man of the two, but he worked under Vanbrugh as well as under Wren, and his work shows clearly how much he was influenced by Vanbrugh's ideas. For this reason it will be more convenient to deal with Vanbrugh first.

John Vanbrugh was the son of a rich sugar-baker, and was born in 1666. He occupies a unique position among English architects. For the first thirty-five years of his life he devoted himself to literature with brilliant success, and acquired a distinguished reputation which holds to this day. He then, for reasons unknown, suddenly transferred his exuberant energy to the practice of another art, and astonished the world by a series of portentous buildings without parallel in modern architecture. These buildings met with merciless ridicule from all the critics of the time, and it has been the general habit to treat Vanbrugh's architecture as something altogether abnormal and absurd. Sir Joshua Reynolds alone has spoken strongly in its favour. In his thirteenth discourse he maintains that "there is a greater display of imagination" in Vanbrugh's buildings than in any others, and particularly praises the skill of composition with which, "to support the principal object, he produced his second and third groups or masses." Reynolds admitted that he judged of architecture merely as a painter, and it is evident

from his remarks, for his defence has to some extent given Vanbrugh away. The weak point of Vanbrugh, the fault which showed most clearly his want of training and his ignorance of the actual conditions of architecture, was precisely this habit of approaching architecture from the point of view of a painter, or rather of a scene painter, the habit of considering a building and the parts of a building as simply so much material for effect, without regard to their reasonable use and the necessary limitations of design. It is possible that Vanbrugh's success with stage scenery suggested to him the idea of realizing his canvas palaces in stone, and his great popularity with the Court very soon gave him the opportunity.

In 1702 Vanbrugh was appointed comptroller of the works in succession to Talman. His earliest completed building was a theatre, 1703-5, afterwards burnt down. He was, however, already engaged on the designs of Castle Howard, begun in 1702 and finished in 1714. Here, and afterwards at Blenheim, the leading idea of his plan was, as Reynolds pointed out, to support his main group by subordinate groups of buildings. Starting from the main block of buildings with a façade to the gardens of 300 ft., he threw out colonnades from the advanced angles of this block towards the forecourt, placed the kitchen court and offices to the left, and the stable court to the right, giving a total frontage of 660 ft. At Blenheim he simplified this plan and set the main block still farther back from the advanced courts to the right and left, improving the proportions of the forecourt, and providing a fine vista from the entrance to the kitchen court right across the forecourt to the stable court beyond. The main block at Blenheim has a frontage of 320 ft., and the total frontage (as figured in Campbell) is 856 ft. In the plans of both houses there is the same arrangement of a hall with staircases on either side, leading to a salon beyond with access to the principal apartments *en suite* to the right and left. In both houses, in spite of their enormous size, there is hardly a single really fine room. At Castle Howard the grand salon is 34 ft. by 25 ft., and at each end of the garden façade is a room 40 ft. by 15 ft. with a semicircular bay; but there is nothing approaching Inigo Jones's double cube room of 60 ft. by 30 ft. at Wilton, a very much smaller house; and at Blenheim, except the great salon, 42 ft. by 35 ft., and the great gallery, 182 ft. long, there is hardly a fine room in the

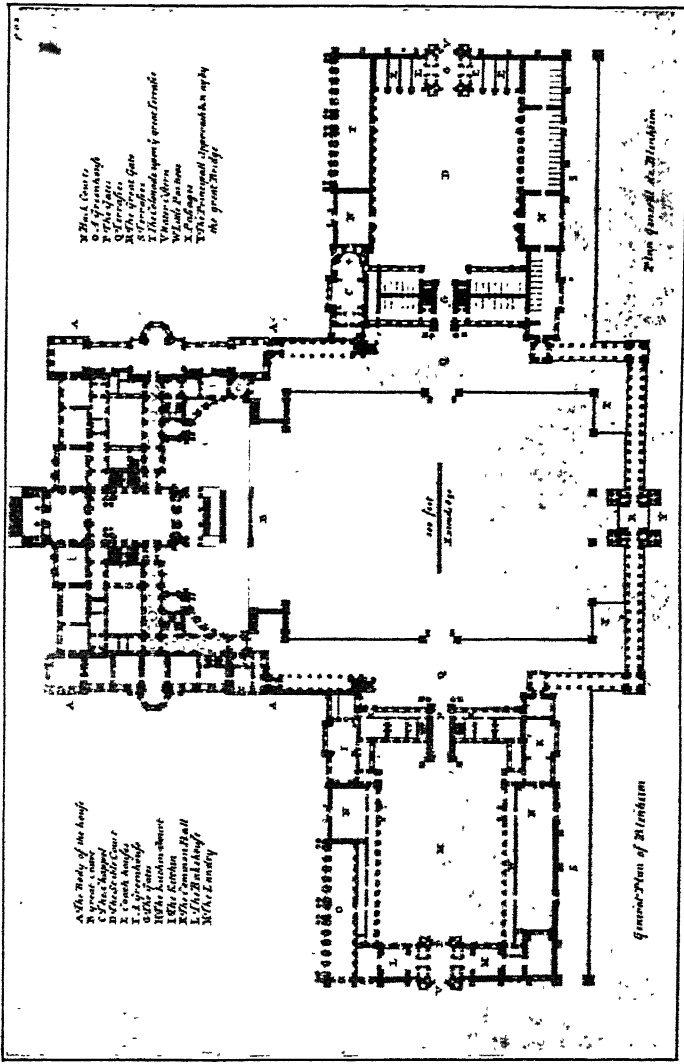

A The Study of the Architect
 B Green's room
 C The Chapel
 D The Library
 E South Passage
 F The Gallery
 G The Picture Room
 H The Kitchen
 I The Dining Room
 K The Banquet Hall
 L The Ball Room
 M The Laundry

N The Court
 O The Greenhouse
 P The Office
 Q The Office
 R The Office
 S The Office
 T The Office
 U The Office
 V The Office
 W The Office
 X The Office
 Y The Office
 Z The Office

General Plan of Blenheim

Plan of the Blenheim

PLAN OF BLENHEIM.
 ("Vitruv. Brit." i. 62.)

house. Several of the rooms are ill-lighted, and their shape entirely sacrificed to the elevation. The last thing that Vanbrugh had in his mind was the personal comfort of the inmates of the house. Provided he made his effect he was satisfied. Vanbrugh was knighted in 1714, and in 1716 made surveyor of Greenwich Hospital in succession to Wren. His principal works, besides Blenheim and Castle Howard, were Eastbury in Dorsetshire (1718), destroyed about 1750, King's Weston, near Bristol, a house for Mr. Duncombe in Yorkshire, Oulton Hall, Cheshire, and Seaton-Delaval in Northumberland (1720-21). In all these designs there appears the same almost morbid anxiety to design his details on a scale that had never been seen before.

Yet it is evident, from a comparison of the dates of his work, that Vanbrugh was steadily advancing in mastery of his art till the time of his death. The details of Seaton-Delaval (1720) are less forced than those of Eastbury (1718), and both these houses show a distinct improvement on his earlier planning. Vanbrugh had probably learnt by experience that a great quantity of small rooms was not the right way to get a fine internal effect. Grimsthorpe (1724), his latest work,¹ is, by comparison, a well-arranged and convenient house; and though he could not shake himself free of his gigantic rusticated columns, 3 ft. 6 in. in diameter, and of certain enormous key-blocks, the front is an unaffected and almost reasonable design. Had Vanbrugh lived longer it seems that he might have become a really great architect.

Vanbrugh died in 1726. His conceptions were far beyond his powers of execution, and his mind was possessed with a single idea, almost amounting to megalomania. His larger plans are all based on the general scheme already described in reference to Blenheim and Castle Howard, and the one impression which he sought to convey was the majesty of stupendous size. His mind, with all its vigorous energy, seems to have run in a groove, and he does not seem to have been alive to the value of anything but his own peculiar manner. Yet Vanbrugh was certainly an original designer. Even in his details, uncouth and ugly as they are, there is evidence of thought in the design, of a deliberate attempt to make them all subordi-

¹ Vanbrugh's work at Grimsthorpe consisted of large additions to a much earlier house. The back of the house remains in its original state.

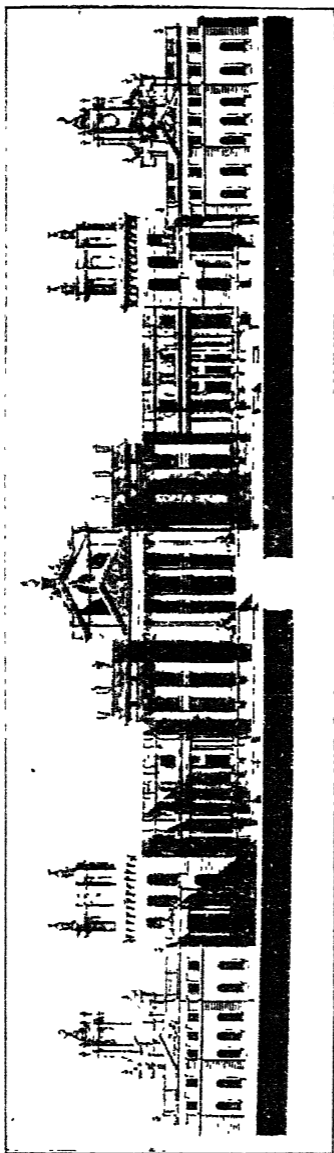

ELEVATION OF BLENHEIM PALACE.

(“Vituv. Brit.” i. 57.)

nate to his main idea. He certainly conceived of his building as a whole. He was not content to accept the ordinary way of doing things, but endeavoured to think out his design in his own peculiar fashion, and according to the dictates of his very ill-balanced taste. If, to his powerful imagination, Vanbrugh had joined any degree of artistic sensitiveness, he might have succeeded in his effort after great architecture; for he grasped the fundamental principle that the highest effects of architecture can only be reached through the qualities of architecture, not, that is, by sculpture, however fine, but by fine proportion and distribution of mass. Unfortunately Vanbrugh had no taste, and his ambition for size rapidly grew into what can hardly be separated from mania. At Blenheim, not content with the size of the house, he built the great bridge on about four times the scale of the house, constructing this Titanic monument to cross the upper end of a pond. The simple question of cost would always prevent any serious effort to follow Vanbrugh's lead; and Hawksmoor, who made the attempt in a small way, completely over-reached himself in this regard; yet Vanbrugh remains an interesting figure in the history of English art. His passionate appreciation of the abstract qualities of architecture gives him a place by himself among the architects of a country in which the very existence of those qualities has almost ceased to be recognized.

In the "Vitruvius Britannicus" a certain William Wakefield is referred to as the architect of Duncombe Park, Atherton House in Lancashire (1723), and Rookby Park in Yorkshire (1724). It is evident that he closely imitated Vanbrugh, and probably was intrusted with the superintendence of some of his designs in the north as Vanbrugh's health failed. Nothing more is known of Wakefield as an architect.

Vanbrugh's successor was Hawksmoor, born at East Drayton in 1661. At the age of eighteen he entered Wren's office as "his scholar and domestic clerk"; and for the next thirty years of his life served Wren faithfully in the superintendence of his various buildings. In 1683 he was employed by Wren as supervisor at Winchester, and deputy-surveyor at Chelsea Hospital. In 1690 he was appointed clerk of the works at Kensington Palace; in 1698, clerk of the works at Greenwich Hospital; and in 1705, deputy-surveyor. He also worked for Wren at Queen's College, Oxford, in 1692-95, the date of the

library, which was designed by Wren and not by Hawksmoor. Till the end of the seventeenth century he had been working entirely for Wren ; but when Castle Howard was begun in 1702 he assisted Vanbrugh, and was appointed his deputy-surveyor at Blenheim, 1710-15 ; and from 1715 till the time of his death, in 1736, besides work which he carried out on his own account, he filled various official posts, such as that of secretary and draughtsman to the Board of Works and deputy-surveyor. Hawksmoor's manner was thus derived from two very different sources, and the influences of Wren and of Vanbrugh appear in his work, not always in perfect fusion. From Wren he learnt his technique, and acquired a mastery of architectural detail far beyond the limited knowledge of Vanbrugh. But the latter influenced his design in an unmistakable manner ; the effort after simple size which is found in Hawksmoor's work, his constant ambition to pile up great masses of masonry, must be attributed to his association with Vanbrugh. The consequence was that Hawksmoor, who was a well-trained architect, was incessantly trying to translate Vanbrugh into terms of Wren, and while, owing to his tamer nature, he missed the turbulent power of Vanbrugh, he was prevented by the ideal at which he aimed from attaining the grace and suavity of Wren. The tower of St. Mary Woolnoth is a characteristic example of this. The lower storey of the west front is on the scale of Blenheim, and an evident reminiscence of Vanbrugh ; the stage above this is slightly out of scale with the lower storey, though not aggressively so ; but above the entablature of this stage Hawksmoor seems to have lost all touch of his original motive, and in the two small turrets to have reverted to some recollection of Wren. The finest feature in this church is the north front ; there is much refinement of design in the recessed semi-circular headed niches, and the recondite treatment of the mouldings. Hawksmoor evidently gave a great deal of thought to his designs. He was determined that his details should have a real meaning of their own, and in this regard he was more successful than Vanbrugh, thanks to the training he had received from Wren.

When Queen Anne's Act for the building of fifty new churches was passed in 1708, Hawksmoor was employed as one of the architects, and in 1716 he, with James of Greenwich, succeeded Gibbs as surveyor to the commissioners. The

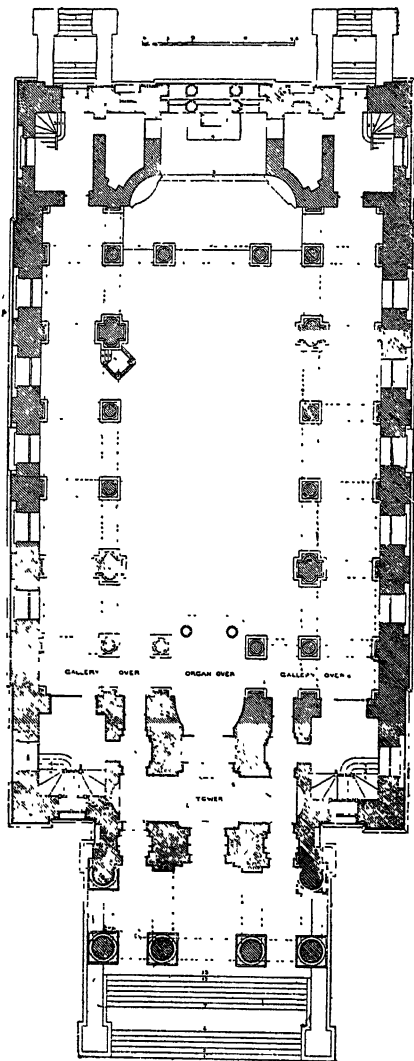

PLAN OF CHRIST CHURCH, SPITALFIELDS.

following churches were built from his designs: St. Anne's, Limehouse, 1712-24; St. George's-in-the-East, 1715-23; St. Mary Woolnoth, 1716-19; St. George's, Bloomsbury, 1720-30; and Christ Church, Spitalfields, 1725-29. Hawksmoor was also the architect of St. Alphege, at Greenwich (1711-18), except the steeple, and he gave designs for St. Giles-in-the-Fields, but these were not carried out. St. George's, Bloomsbury, one of the earliest instances of the church with a projecting portico, and Christ Church, Spitalfields, are on the whole the finest of Hawksmoor's churches. Christ Church, Spitalfields, is in some ways one of the most original churches in London. Its plan resembles the ordinary rectangular church with nave and aisles designed by Wren, but there is a remarkable feature at the east end, and in the tower Hawksmoor broke away from all

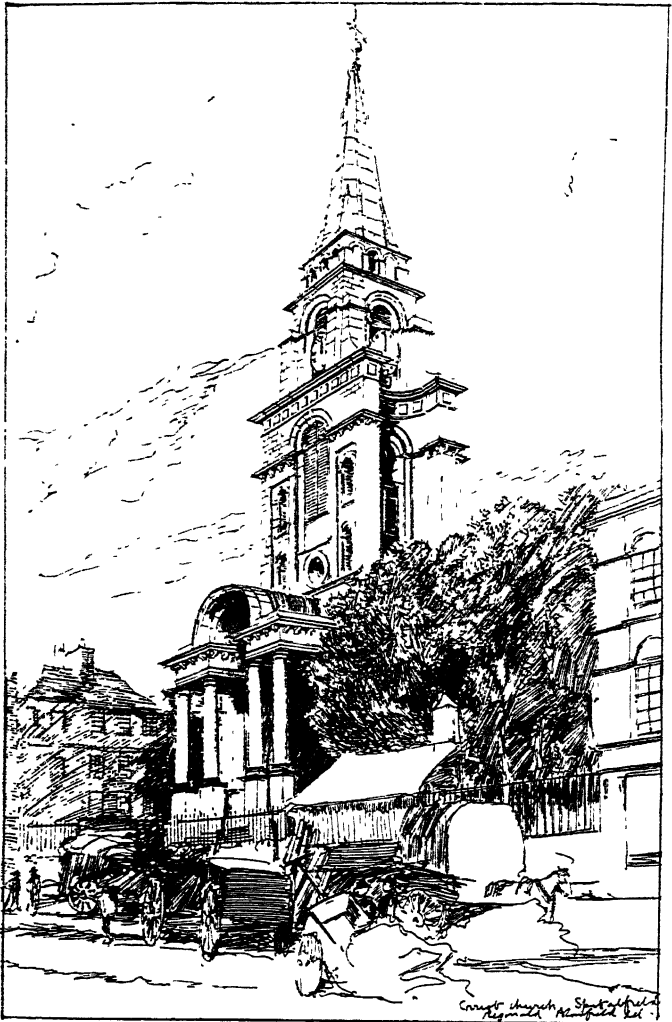

CHRIST CHURCH, SPITALFIELDS.

precedent. At the first column from the east end Hawksmoor has returned the entablature right across from north to south, with two additional columns inserted in the width of the nave, thus forming a screen, and above this he has placed the royal arms. The effect is fine, though somewhat overcrowded. The tower stands at the west end, and beyond it is a bold portico of four detached columns carrying an entablature, with a semicircular vault above it in the centre. The plan of the tower is square, but Hawksmoor has extended the east and west walls towards the north and south for about two-thirds of the way up, so that it is wider on the face than on the side, and has then come back to the square with curved ramps. Above this is a low square stage, terminating in an octagonal steeple. The design is full of peculiarities, such, for instance, as the circular sweeps of the entablature on the north and south sides, the little arcaded stage below the steeple, and the bold ramps which terminate the buttresses, and its extremely impressive effect is due to purely architectural qualities; that is to say, there is no carving or ornament on the tower, and it depends solely on its proportions and the disposition of its planes.

Hawksmoor's best and worst work is to be found at Oxford. His worst work is the north quadrangle of All Souls' College. Hawksmoor was consulted on the advisability of destroying all the old buildings. He pleaded, however, for the preservation of all that "was strong and durable," and it is probable that it was in pursuance of some vagary of the college authorities that Hawksmoor here attempted a Gothic design. The towers on the east side are among the very worst examples of new Gothic design to be found in this country. In its want of apparent stability and its hard, mechanical feeling, this design is inferior to Wren's Gothic, and Hawksmoor had so entirely lost touch of the intention and constructive reasonableness of Gothic architecture that he has here placed a very large and solid pinnacle immediately over the centre of a window. Hawksmoor also made designs for a new front of All Souls' to the High Street, for rebuilding Brasenose College, and for the Radcliffe Library, none of which were carried out, and in 1715 he made plans for rebuilding King's, Cambridge, but, as in the case of the Radcliffe, his designs were rejected in favour of Gibbs.

Hawksmoor's best work at Oxford is the south quadrangle

at Queen's, including the hall, chapel, and the front to the High Street, and the old Clarendon Press buildings, in which he was associated with Vanbrugh. These buildings seem to have been designed about 1710, when Hawksmoor was working at Blenheim, and they show evidence of a common motive. Both in the south quadrangle of Queen's and in the Clarendon Press buildings there is the same treatment of bays: the two storeys are brought into a single panel by being recessed between pilasters carried up from the plinth to the entablature, and both the hall and chapel of Queen's and the Clarendon Press have the huge single order which was afterwards imitated by Clarke at Christ Church, and which had been deliberately rejected by Wren at St. Paul's as wasteful and impracticable. The Clarendon Press is more successful, and on its own inhuman system of proportions is very finely designed. It is probable that Vanbrugh gave the general idea, but that Hawksmoor made the drawings and superintended the work, for which he received a gratuity of £100. The design is of a better quality than any by either Vanbrugh or Hawksmoor singly. The scale is well maintained throughout, the details are simple, and in its general balance and light and shade the building is an impressive instance of architecture in the grand manner. The worst of "the grand manner" in a town is that, owing to its excessive costliness, it has but rare opportunities, and consequently, as in this case, overpowers the adjacent buildings. Hawksmoor succeeded Wren as surveyor to Westminster Abbey in 1723, and completed the west towers. His latest work was a pamphlet on old London Bridge, with plans for its improvement, and he also prepared designs for a new bridge at Westminster, which were never carried out. Hawksmoor died in 1736. He was a modest, unassuming, and honourable man, of exact care in details, and great mechanical knowledge. When Beverley Minster was in imminent danger in 1713, he invented the machinery for screwing up the north part of the north transept, and in all technical knowledge of architecture he was superior to Vanbrugh, who, so far as is known, never had any training at all. The quality of his imagination was ungraceful and ponderous, yet Hawksmoor was an original designer, and he seriously grappled with the problems of architecture, instead of merely copying Palladio and the accepted Italian models. There is a definite individuality about his work which com-

pensates for its inferiority, in other regards, to the more correct and distinguished manner of the eighteenth-century architects.

Architecture had already become an elegant accomplishment of the upper classes. To the free masculine intelligence of Wren had succeeded mere scholarship, rapidly degenerating into pedantry. When a correct use of the orders, according to the recognized canons, was the test of architecture, and the question of cost was seldom raised, the amateur very soon stepped to the front, and began to furnish designs of his own, or at any rate to give instructions to draughtsmen who were content to leave to the amateur the credit of the design, and a little later we shall find Lord Burlington represented as one of the first architects of his time.

The ablest as well as the earliest of these amateurs was Henry Aldrich, Dean of Christ Church (died 1710). Aldrich's reputation rests on more or less solid grounds. He left in MS. a collection of notes on the elements of civil architecture, in accordance with the rules of Vitruvius and Palladio, which was published in 1789, and no suggestion has been made that his designs were actually made by anybody else, though as Wren and Hawksmoor were often at Oxford, it is probable that he availed himself largely of their advice. His best work is the Church of All Saints, Oxford. Aldrich was an accomplished man, and, within the narrow limits that he set himself, gained a fairly complete mastery of his style. He designed the garden front of Corpus College at Oxford, and the north, east and west sides of Peckwater quadrangle, Christ Church. The latter is a fair example of rather uninteresting, but correct, Palladian design, except for the wide spacing of the pilasters.

Its effect, however, is spoilt by the library on the south side, designed in 1716 by Dr. Clarke, another amateur, who testified his friendship for Aldrich by putting up a tablet to his memory, but showed a very singular disregard of his work when he designed this library, which quite overpowers the rest of the quadrangle. The library was not finally completed till 1761. Clarke died in 1736, and bequeathed his collection of drawings, including the designs of Inigo Jones, to Worcester College. It is probable that he had advised on the library of this college, if he did not actually design it. There can be little doubt that both Aldrich and Clarke were consulted on most of the buildings erected in Oxford between 1680 and 1730,

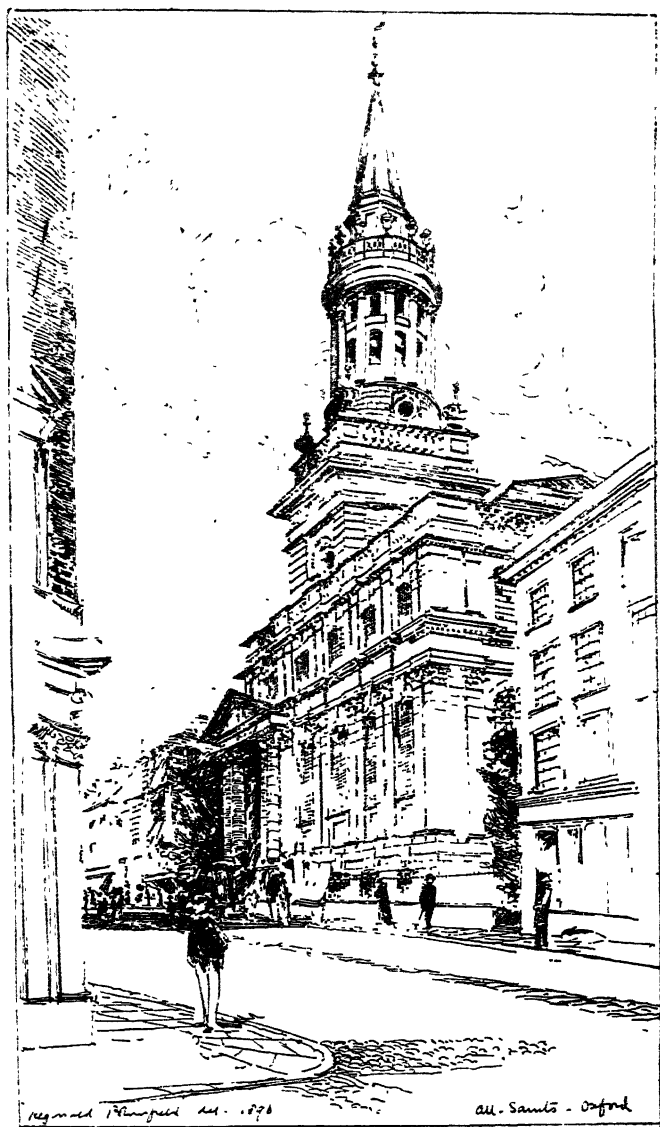

ALL SAINTS', OXFORD.

M

and, on the other hand, that in their own designs they had the advantage, first of Wren's and afterwards of Hawksmoor's advice, and not improbably of Hawksmoor's draughtsmanship. This is evident in the case of Clarke's design for the Christ Church Library. Aldrich's design for All Saints', though it suggests Wren's influence, shows a more definite individuality.

The Cambridge amateurs were later in the field, and I have to interrupt chronological sequence in introducing here some mention of "that ingenious architect," Sir James Burrough. Burrough was born in 1690, was elected to the mastership of Gonville and Caius College in 1754, and died in 1764. "During his university career he practised architecture to a considerable extent, but in what manner his previous education had prepared him for it does not appear. His works are certainly not characterized by great artistic power, and are all in the tamest Italian style;"¹ a very just summary of Burrough's architectural attainments. In 1728 he designed a cupola at Caius, and in 1732 he converted the old hall of Queen's College into an "Italian chamber." In 1736 he gave a design for the new buildings at Peterhouse, the scene of his most unfortunate experiment in architecture, for, in 1754, he was allowed to transform the mediæval quadrangle of this college into an Italian design. Burrough was keenly interested in building: he had all the amateur's weakness for alteration for the sake of alteration, for the simple pleasure of seeing a building grow under his hands without regard to its necessity, and without scruple as to the associations sacrificed in the process. In 1745 he Italianized the court of Trinity Hall, and in 1751 the court of Caius College, and in the same year designed the Doctor's Gallery, in the Church of St. Mary the Great. Burrough's work showed no evidence of the ability of Aldrich or even of Clarke, and his influence was distinctly for the bad in the history of college architecture. He was one of the first to introduce the habit of altering and rebuilding ancient buildings, merely because they were not in accordance with the style in fashion at the time, a habit equally disastrous, whether the result was neo-Italian, neo-Gothic, or neo-Greek. The two universities have, in fact, suffered severely from the efforts of zealous amateurs; the ravages of Burrough and his contemporaries on the sixteenth

¹ Willis and Clarke, iii. 536.

and seventeenth century architecture of Cambridge have been repeated in this century in an aggravated form at both universities, and that by eminent architects acting under the instructions of persons whose zeal for mediævalism and ignorance of its real character were about evenly balanced.

James Essex, who helped Burrough in his works, was actually an architect, though not a particularly good one; his father was a joiner at Cambridge, and Essex seems to have been apprenticed to his father, and to have crept into practice by making himself indispensable to the university amateurs. His earliest design was one for the gardens of King's in 1741. In 1757 he designed the Ramsden Buildings at St. Catherine's Hall, including the chapel, perhaps his best work, though rather coarse in detail. By the middle of the eighteenth century the process of "Italianizing" the earlier buildings was in full fashion at Cambridge, and Essex was employed for this purpose at Trinity, St. John's, and Christ's Colleges. At Trinity he cut away the Jacobean pilasters in Neviile's Court, and substituted a balustrade for the picturesque old gables. Essex, indeed, is not an architect to whom one feels very kindly: he designed the west front of Emmanuel, 1770-75, and the altar-piece in King's Chapel in 1770, and completed the Chapel of Clare, begun by Burrough; but he also destroyed a considerable quantity of very interesting earlier work, and his own performances were indifferent, though he appears to have been a useful person to the Cambridge amateurs. The appearance, indeed, of the amateur in the field was a dangerous sign. It was partly the cause and partly the effect of a change of direction in the development of English art. The artistic strength and ability that had hitherto found its adequate expression in architecture and craftsmanship was gradually drawing away into other channels, and concentrating itself in the art of painting to the neglect of the other arts. Perhaps this was the Nemesis that awaited the magnificent ambition and consummate accomplishment of the mature Renaissance: in any case, the inevitable decline from that great period had begun. England was soon to possess painters of first-rate genius, but as a set-back to this, architecture fell into the hands of men of inferior ability, with the result that traditior was abandoned for merely individual caprice.

CHAPTER IX

THE EIGHTEENTH CENTURY ARCHITECTS: ARCHER, JAMES, CAMPBELL, RIPLEY, LORD BURLINGTON, LEONI, KENT

PROBABLY at no time in the history of English architecture has there existed a more perfect knowledge of the technical arts of building than at the beginning of the eighteenth century. Wren and his contemporaries had trained up a highly intelligent school of masons and carpenters, capable of executing the details of Palladian architecture from the roughest indication, so much so that Switzer, writing in 1718, was able to refer to the skill of the English masons as a matter of common knowledge. Moreover, the architects of this period possessed an intimate knowledge of Palladian architecture. Its subtleties and refinements were made a matter of profound study, and even the least capable of the brilliant group of architects at work in England for the first half of the eighteenth century were perfectly trained in the scholarship of design as then understood. A knowledge of the orders and their right use and proportions, of the variations of usage exhibited in the works of Serlio, Vignola, Palladio, and Scamozzi, of the remains of Roman architecture, and of the rules prescribed in "Vitruvius" and the great Italian text-books, was considered indispensable to an architect; and the fine, if somewhat frigid, architecture of the first half of the eighteenth century was the outcome of a training absolutely thorough and complete within its peculiar limits. The architecture of the first half of the eighteenth century is not always interesting, but it is seldom ignorant in construction or vulgar in design.

Archer, James, Campbell, Gibbs, and Kent were almost contemporaries, and it is not possible to preserve strict chronological sequence in dealing with the successors of Wren. It must be understood, however, that till we come to Chambers and the Adams, the architects mentioned were all more or less of the

same standing, and belonged, generally speaking, to that later school of English Palladian architecture, of which the ablest representatives were Campbell and Gibbs.

Thomas Archer was the son of Thomas Archer, M.P. for Warwick, and was a person of some consideration, being appointed groom porter to Queen Anne, George I., and George II. He was a pupil of Vanbrugh, whose influence probably accounts for certain eccentricities of manner in an individuality not otherwise remarkable. Archer's first work was Heythorpe Hall in Oxfordshire, 1705. In 1709 he designed the elaborate pavilion at the head of the Long Water in Wrest Park, and in 1710 Mr. Cary's house at Roehampton, a design only noticeable for the great broken pediment, a motive which Archer developed later at St. John's, Westminster, with singular results. In 1710 he also designed the Church of St. Philip, Birmingham, which, Campbell says, "was justly esteemed a very beautiful structure." The tower at the west end is helped by its commanding position, but is certainly a powerful and original design, and unlike anything of its kind in England. It is very much finer in execution than would

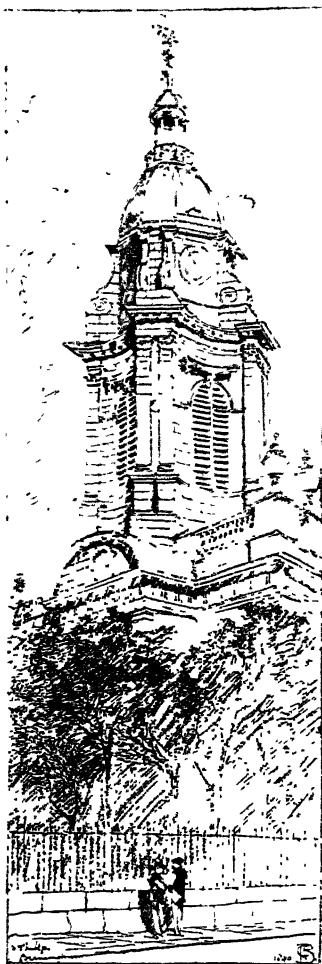

ST. PHILIP'S, BIRMINGHAM.

appear from Campbell's plate.

The tower starts from above the entablature of the church and consists of a belfry-stage with four concave sides, and double engaged pilasters on pedestals set on the canted angles. Above the entablature of this belfry is an octagonal stage for a clock, with double buttresses running out to the angles of the lower stage, and a lead dome terminating in an open lantern with a cupola and an iron cross. The play of concave wall surface in contrast with the square returns, and the very ingenious transition from the square to the octagon, a little suggest some of Hawksmoor's elaborate combinations of plain and hollow surfaces. Archer evidently had no intention of adhering to the type of steeple invented by Wren, and continued later by Gibbs. The lofty belfry-stage of St. Philip's shows that he deliberately rejected Wren's favourite device of getting his effect by constant repetition of storeys; and it is possible that he shared with Campbell and his contemporaries their somewhat disparaging view of Wren's powers as a designer. Of its kind St. Philip's is one of the finest steeples in England and does more to justify Archer's reputation than his ambitious venture at St. John's, Westminster, built 1721-28, at a cost of £40,000. In 1730 Archer designed a church at Deptford, and in 1741, Umberslade in Warwickshire. He died in 1743.

John James of Greenwich succeeded Hawksmoor as clerk of the works at Greenwich in 1705, and his work closely resembles Hawksmoor's. As was the case with several of the early eighteenth-century architects, James was a man of some literary ability, and published in 1708 a translation of Perrault's treatise of the five orders, in 1710 a translation of Pozzo's rules and examples of perspective, and in 1712 "The Theory and Practice of Gardening," probably by Le Blond or D'Argenville Dezalliers, but the authorship was unknown to James himself. The book is a very interesting and complete account of the system of garden architecture practised by Lenôtre and his school, and is of considerable importance in the history of English architecture, inasmuch as the system of design which it describes was employed in laying out the grounds and gardens of all the great houses built at about this period. In 1711 James succeeded Jennings as master carpenter at St. Paul's, and in 1716 he was appointed assistant-surveyor to St. Paul's, and surveyor to the commissioners for building new churches. His

finest design is the important Church of St. George, Hanover Square, 1713-24, with the well-known portico. The dates of the building of this church and of St. George's, Bloomsbury (1720-30), overlap, and it is therefore a little uncertain whether the credit of having originated this portico treatment should be given to James or to Hawksmoor. James also designed St. Mary's Church at Twickenham in 1713, and a new steeple to St. Alphege at Greenwich in 1730. Of his domestic architecture the only known examples are a house at Twickenham, illustrated by Campbell, and a large house near Blackheath built for Sir Gregory Page in 1721 and destroyed 1787. James died in 1746. He was a capable architect, learned in his art, but somewhat overpowered by his own learning.

The weak point, in fact, of nearly all these early eighteenth-century architects is their lack of individuality. There is abundant indication in their work of knowledge of architecture, but little trace of enthusiasm or inspiration. It is just a trifle cold and colourless; so much so that, without documentary evidence, it would often be difficult to say whether any given building was by James or Archer, Kent or Campbell. Documentary evidence, however, exists in abundance. These able men were not disposed to leave posterity in ignorance of their attainments. The eighteenth century was from the first fully conscious of its own enlightenment: later in the century Wolfe and Gandon professed their ability to convince posterity "that architecture was brought to as great a point of perfection in this kingdom in the eighteenth century as ever it was known to be among the Greeks and Romans, and that if we were not inferior to the ancients in this respect, we far surpassed our contemporaries of every other country." In this happy confidence the fashion of publishing sumptuous books of measured drawings was introduced very early in the century. It is for this reason that records remain of several architects of capacity, but nothing approaching genius, such as are unfortunately wanting in the case of their predecessors. Though the value of these records is great, they cannot be trusted implicitly. No such thing as strict historical accuracy existed at the time, and the subjects of the plates were selected quite as much to suit the predilections and personal advertisement of the author as for the

¹ "Vitruvius Britannicus," i. 77.

impartial illustration of architecture. The most conspicuous offender in this regard was Colin Campbell.

Campbell was a protégé of the Duke of Argyll, and when he came to London early in the eighteenth century, he hit on the happy idea that the best method of advancing his own interests was to publish a series of plates illustrating the works of English architects of admitted reputation, in which he was free to insert numerous designs of his own invention. This may appear a somewhat harsh criticism on a man who, whatever his defects, did certainly render great service to the history of architecture by this undertaking; but a survey of the first three volumes of the "Vitruvius Britannicus" leads inevitably to the conclusion that Campbell was either uncritical and ignorant of the best work then done in architecture, or that he was malicious and uncandid. His professed object was to make his collection typical; yet of Wren's buildings he only illustrates St. Paul's, Marlborough House, and Bow Steeple. Greenwich is included, but Campbell omits to mention that Wren had anything to do with its design, though he finds room for extravagant rhapsodies on "the beauty, the force, the majesty, of a British pencil"—the pencil, that is, of a third-rate painter, Sir James Thornhill, who was employed to decorate the interior. On the other hand, Campbell presents us with Mr. Benson's design¹ for his own house at Wilbury, a great many designs of his own, and a series of fulsome panegyrics on the learning, generosity, and goodness of his various noble patrons.

Campbell's introductory notices are in fact the worst part of his book. He was much more occupied with the noble patron than with the architect, and his criticisms on architecture, in so far as they are *bonâ fide*, have regard to the correctness of the design according to academic rules, rather than to its reasonableness or imaginative power. Notwithstanding these vices of taste and temperament, Campbell was himself an accomplished architect. His earliest recorded work was a small house at Shawfield, near Glasgow, for a Mr. Daniel Campbell, of no particular interest, built in 1712, and to this smaller type of house belong the designs for Sir Charles Hotham's house at Beverley, and a house at Chester-le-Street, Durham. Campbell's first important work was the new front

¹ Mr. Benson is the person already referred to in the chapter on Wren.

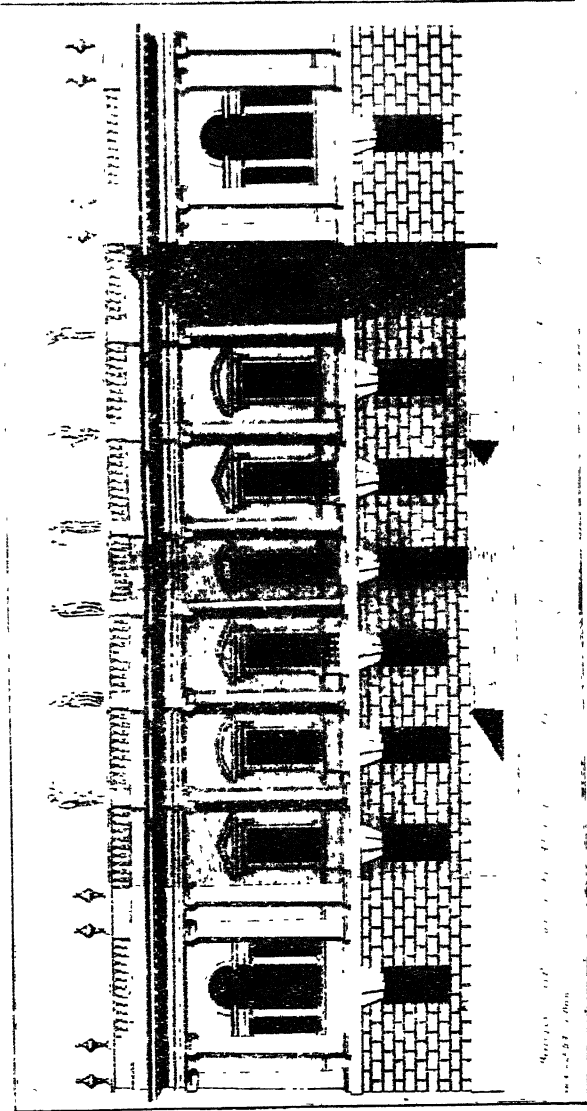

ELEVATION OF OLD BURLINGTON HOUSE.

(“Vitruv. Brit.” iii. 23-24.)

and gateway of old Burlington House, 1717-18. The front was in two storeys, and consisted of a rusticated basement, with an Ionic order over, surmounted by a balustrade; the two projecting wings at the ends had Venetian windows; to the right and left of the forecourt were the stables and kitchen. According to Campbell, and there is no reason for doubting his account, he designed all, except the stables and kitchens. In 1718 Campbell designed the Rolls House in Chancery Lane, one of the best examples of his less ambitious manner;¹ and he repeated the general elevation on a different plan in Mr. Plumptre's house at Nottingham. In 1720 he designed Newby in Yorkshire, a square house, on a very ingenious plan, measuring 76 ft. by 76 ft. Stourhead in Wiltshire is another variation of the same motive, on a plan 92 ft. by 82 ft. In 1720 Campbell made the important designs for Wanstead in Essex. His first design was a three-storeyed building with a frontage of 200 feet. This was materially modified in the second design, which was given a total frontage of 260 ft., and instead of a regular façade in three storeys, the nine centre bays were carried up three storeys, with a hexastyle portico (according to Campbell, the first of its kind in England), and an open cupola over the centre, while the six bays at the sides were kept to two storeys. Campbell's description of the plan is typical of the grand house of this period. "You ascend from the court, by double stairs of each side, which land in the Portico, and from thence into the great hall, 51 feet long and 36 wide and in Height the same. This leads into the Salon, being an exact cube of 30 feet, attended with 2 noble apartments of state, all fronting the Gardens." Campbell designed two towers or pavilions for the angles, which do not appear to have been carried out. The whole of this house, considered in its time the finest in England, was destroyed in 1824.

In 1723 Campbell designed Houghton in Norfolk for Sir Robert Walpole. The general plan consists of a great central block, with 166 ft. front, connected by quadrant colonnades with two subordinate blocks containing the laundry court and kitchen court respectively, and giving a total frontage of 450 ft. Certain variations were made by Ripley, who superseded

¹ Destroyed in 1895-96.

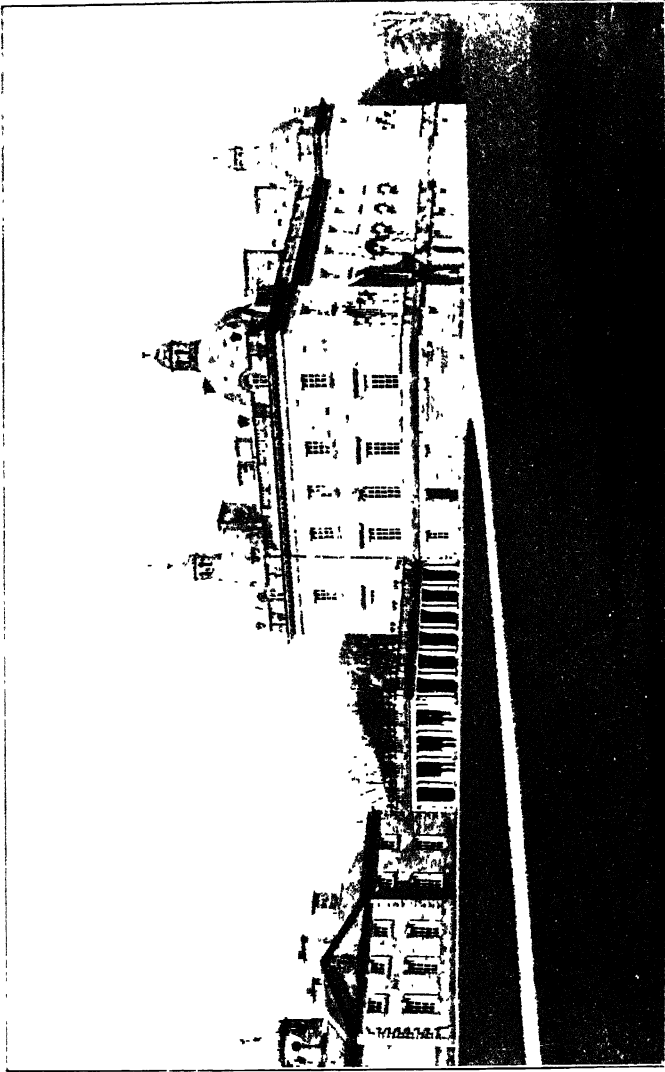

H. Applegate, photo.

GEORGETOWN STATE NORMAL

Campbell; but the design is essentially Campbell's; and the general effect, in spite of a certain clumsiness of detail, is exceedingly fine. Campbell's next important building was Mereworth Castle in Kent. This extraordinary design for an English country house illustrates the gradual decay which was overtaking English architecture. Palladio once made a skilful design of a villa for Monsignor Paolo Almerigo, consisting of a circular hall inclosed in a square, and surrounded by rooms *en suite*. This villa was well adapted for a summer residence in a hot climate. It provided shelter from the blazing sun, and a free current of air in all directions, two qualities essential in Italy, but which exactly disqualified it for a country house in the damp cold atmosphere of the North. Notwithstanding, this design was so much admired by the aristocratic *virtuoso* of the eighteenth century that he was moved to transplant it entire to England, and Campbell duly reproduced Almerigo's villa at Mereworth. Chimneys would have spoilt the effect, and accordingly Campbell (who was certainly a most ingenious person) managed to get rid of his flues through the dome. He formed the dome over the great central hall in three parts, an inner plaster ceiling, an outer dome of wood covered with lead, and between the two a brick dome through which the flues were conducted to discharge their smoke through a small copper cupola at the top. The hall was 38 ft. in diameter and 60 ft. high, and the only light it received was from four circular openings 5 ft. in diameter in the dome. Vanbrugh's extravagance was as nothing to the absurd wastefulness of this design, which was also reproduced at Foot's Cray in Kent, and for Lord Burlington at Chiswick. Such buildings can only be taken as indications of a morbid tendency in architecture, and as the results of a patronage both ill-instructed and obstinate. The decadence which had already begun was the result, first, of the attempt of architects to make of their art a mystery of fixed rules and canons revealed only to the initiated, and of themselves a close corporation of pedants, and secondly, of the unfortunate fact that architecture had now become a fashionable hobby. The result was that architecture was losing its touch with the daily life of the English people. It ceased to interest the common intelligence, and the interest so lost has never been recovered. Instead of meeting actual wants, and submitting to their wholesome limitations, architec-

ture was now considered a polite art, its guidance was in the hands of the amateur and the dilettante, indifferently controlled by the unquestionable knowledge of the architects of the eighteenth century. The next step downward was to subordinate architecture to literary fashion, as we shall see later on in the case of Kent, with the result of the final loss of tradition in architecture, and the more or less complete extinction of any possible starting-point for a new development.

Campbell repeated the circular central hall and general design of the Mereworth plan in his fine design for Goodwood (1724), which was never carried out. In 1724 he designed Lord Herbert's house in Whitehall, since destroyed, and a large garden house at Hall Barn, near Beaconsfield, an ambitious but unsuccessful attempt at an impressive building. Campbell died in 1734. That he was an architect of ability and knowledge is clear from his designs; but he never showed the slightest inclination to stand out against the preposterous ideas of his patrons, and indeed his own taste was by no means to be trusted. Where he copied Palladio he introduced some of his worst features, and he was apt to repeat himself; but he possessed a certain power of invention, and designs such as Houghton, the Rolls House, and Goodwood show that he was a much more able architect than subsequent writers have been willing to allow.

Giacomo Leoni, a Venetian architect, owed his introduction to England to the munificence of Lord Burlington. He appears to have come over to England, about 1715-16, to superintend an edition of Palladio, which was published in London in that year, and it is possible that about this time Leoni designed the colonnade connecting the offices with the street wall of Burlington House. This colonnade, as I have mentioned before, Campbell either designed himself or found in existence at the time. Leoni spent the rest of his life in England, and carried out various buildings, of which the most important were Moor Park in Hertfordshire, built at a cost of £150,000 in 1720; Moulsham, in Essex; Latham Hall, Lyme Hall, and Bold Hall, in Lancashire; Burton Park, in Sussex, destroyed 1862; and Clandon, in Surrey. In 1726 he translated and published the architecture of Alberti in three volumes, with twenty-seven additional plates of his own. These include a triumphal arch for Hyde Park, the great house at Carshalton designed for



H. N. King, photo.

Thomas Scawen, in which the columns of Corinthian order were to be 3 ft. 6 in. in diameter and 30 ft. high, the Duke of Queensberry's house in Burlington Gardens, a small house in the King's Road, Chelsea, and some other designs for houses which apparently were never carried out. He died in 1746.

If the first half of the eighteenth century was an age of princely patronage for architects it was also a period of unrivalled jobbery. The credit of designs was claimed and assigned in the most unscrupulous manner, and Campbell, who had some share in the dismissal of Wren, had his reward in the loss of Houghton, through the intrigues of Ripley and Kent, and in 1729, in the loss of the surveyorship of Greenwich Hospital, in which he was superseded by Ripley. Ripley was a native of Yorkshire, and began his career as a carpenter. Through the influence of Walpole, he was, in 1721, appointed chief carpenter to all his majesty's works and buildings in England, in succession to Grinling Gibbons, and Walpole intrusted him with the execution of Campbell's designs for Houghton. In 1726 he succeeded Vanbrugh as comptroller, and about this time he designed the Admiralty buildings, a somewhat clumsy composition, with a very ill-proportioned portico. Ripley also built Wolterton House for Lord Walpole, which Horace Walpole declared to be one of the best houses of the size in England. Ripley's work in Queen Mary's block at Greenwich Hospital, begun soon after 1734, has been described already. In 1739 he helped Kent with the new Law Courts at Westminster, and actually advised the destruction of the vaulting of the Chapter House. He also prepared, in conjunction with Kent, in 1739, designs for new Houses of Parliament, of an estimated cost of £167,067. These plans were approved, but never carried out. Ripley died in 1758. His colleague, William Kent, has for various reasons enjoyed a reputation considerably in excess of his merits. It is necessary, however, to discuss the architectural attainments of his patron, Lord Burlington, before entering on any account of Kent's work. Richard Boyle, Earl of Burlington, was born in 1695, and died in 1753. He was undoubtedly a *virtuoso* of fine taste, with a genuine interest in architecture. It has been customary, however, to represent him as one of the most accomplished architects of his time, a man who, but for his position and social engagements, might have been almost the equal of Inigo Jones. It is necessary, therefore,

to consider his claims in detail. Lord Burlington's principal works are supposed to be the colonnade, and the new front to Burlington House in Piccadilly (1716-17), the villa at Chiswick (1729), General Wade's house in Cork Street (1723-24), the dormitory at Westminster (1723-24), and the York Assembly Rooms (1730-36). The dates are important, as Kent returned to England in 1719, and was given a room in Lord Burlington's house in that year. It will be observed that, with the exception of Burlington House, the dates of all these buildings are subsequent to the date at which Kent began his residence at Burlington House, and they are, without exception, subsequent to Leoni's arrival in England. Taking them in order, Colin Campbell distinctly claims the design of Burlington House (with the exception of the offices) as his own. His words are, "The front of the House, the conjunction from thence to the offices, the Great Gate, and street wall, were all designed and executed by me;" and he gives as the date 1717. In describing the Great Gate, he says that the columns are of the Doric order, etc., "agreeable to the colonnade in the court." Either, therefore, this colonnade must have been already in existence, or Campbell is referring to it as an integral part of his own design for the street end of the forecourt. The colonnade has also been attributed to Giacomo Leoni, and what little evidence there is on the subject makes it probable that Leoni, not Campbell, actually designed the colonnade. Further, Campbell expressly states that the Casino in the gardens at Chiswick, built in the same year, was "the first essay of his Lordship's happy invention." Campbell's claim was not denied or disputed at the time, nor, in fact, was any suggestion made that Burlington was the architect, until Walpole, who disliked Campbell (probably because his father had injured him), and whose accounts are habitually inaccurate, blandly assigned the design to Lord Burlington, ignoring Campbell's explicit statement, the only contemporary evidence in existence. We are therefore justified in concluding that Lord Burlington had nothing to do with the design of Burlington House beyond paying the bill, a remark which will be found to apply to his other designs.

The villa at Chiswick (1729), since altered, was avowedly a copy of Palladio's villa for Almerigo at Vicenza, which Campbell had already reproduced on a larger scale at Mereworth. It was

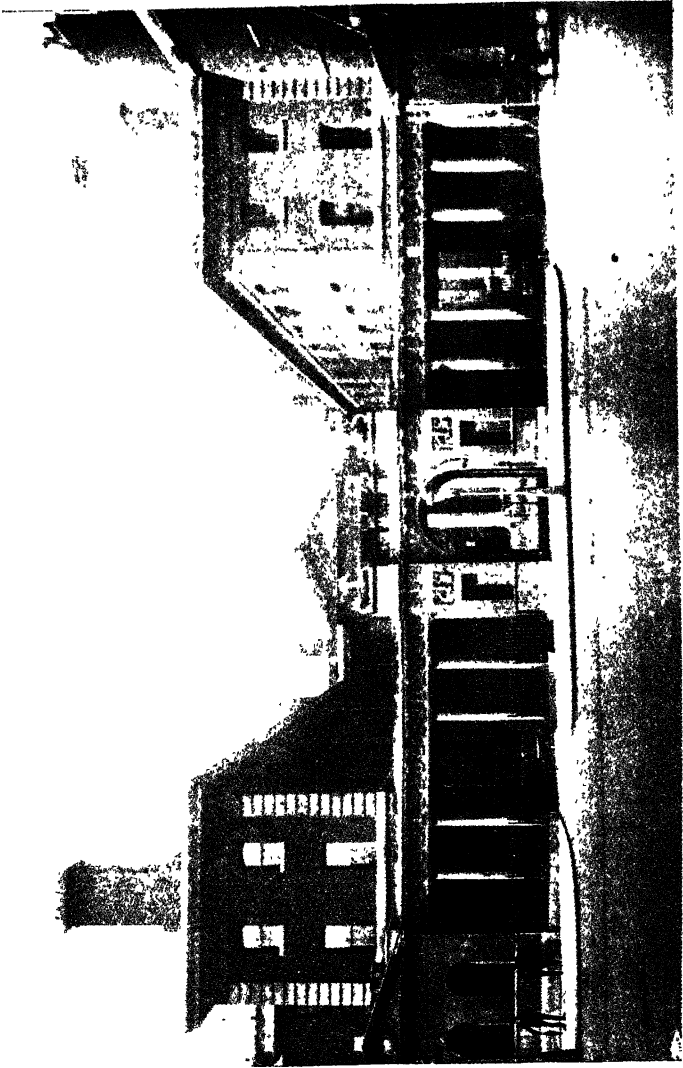

Frith & Co photo

not, therefore, an original design in any case; certain modifications had to be made, involving technical knowledge; and, as Campbell designed the villa at Mereworth before 1723, it is possible that he made the drawings for the Chiswick villa, or more probably Kent, who was now living with Lord Burlington and in his regular employment. The Westminster dormitory is a more crucial case; there is no doubt that Lord Burlington was connected with this building, but the question is, in what capacity? In Plate LI., vol. ii., of Kent's "Designs of Inigo Jones," the design of this dormitory, which was begun in 1722-23, is boldly claimed for Lord Burlington. In the All Souls' Collection, however, there exist various drawings of this dormitory, dated January 14th, 1718-19, which place it beyond a doubt that the original design of this dormitory was by Wren, and that the existing building is only an inferior version of Wren's design carried out under Lord Burlington's directions. It is clear from the Chapter House Records that Burlington undertook the direction of the actual building of the dormitory some four years after Wren's design was made and approved of; and it is further evident, from a comparison of the designs with the building, that he used his discretion very badly in allowing himself to tamper with Wren's design. Lord Burlington occupied a position analogous to that of a chairman of a building committee, and this is probably the only foundation for the tradition that he designed the York Assembly Rooms, which were built when he was lord-lieutenant of the county. Drake ("Eboracum," 1736, dedicated to Lord Burlington) says, "the design was given by that truly English Vitruvius, Richard, Earl of Burlington, from Palladio." Lord Burlington probably suggested the design of the Egyptian Hall, given in Palladio, as a suitable model. Kent, or Leoni, got out the drawings, and Lord Burlington directed the builder, and gave a handsome subscription towards the building.

So far from its being true that Lord Burlington was generous enough to allow to Campbell and Kent the credit of his own designs, the evidence is exactly to the contrary, that Campbell and Kent, in their capacity as paid architects, were content to allow Lord Burlington to trade on their reputations, and in their zeal for his service to claim for him designs which were no more made by Lord Burlington than they were by Campbell or Kent. No authentic drawings by Lord Burlington have yet been pro-

duced, and in the absence of any such evidence, and in view of the facts already advanced, one is justified in concluding that he was no more an architect than any other of the noble amateurs of the eighteenth century. It is probable that the actual designs attributed to Lord Burlington were made either by Leoni, Campbell, or Kent.

William Kent was one of those generally accomplished persons who can do everything up to a certain point, and nothing well. He was born at Rotherham in Yorkshire in 1684, and began his career as apprentice to a coach-painter. He came to London early in the eighteenth century, and, through the generosity of certain gentlemen of Yorkshire, was enabled to travel in Italy, and in 1713 he gained the prize given by the Pope for painting at Rome, and probably soon afterwards was introduced to Lord Burlington, who seems to have formed an extravagant estimate of Kent's capacity as an artist, and in 1719 took him back with him to Burlington House, where he allowed him to reside till his death in 1748. Kent was at first employed as a decorator. He painted the ceilings at Houghton, Rainham, Kensington Palace, Stowe and Wanstead. It does not appear that he ever received any systematic training in architecture, and this may account for the uncertainty of his work. It was not till he entered Lord Burlington's service that he took up architecture. He probably made the drawings for most of the buildings attributed to Burlington, as already suggested; and the latter used his influence to obtain for Kent various official appointments, such as the post of Master Carpenter of all his majesty's works, in which he succeeded Ripley in 1726. Lord Burlington's great reputation as a *virtuoso* speedily made Kent the most fashionable architect of his day. Walpole says that two great ladies begged him to design their birthday gowns: "the one he dressed in a petticoat decorated with columns of the five orders, the other like a bronze, in a copper-coloured satin with ornaments of gold." His designs for furniture and the handicrafts in general were about equally inappropriate. Some, however, of Kent's architectural designs are by no means wanting in distinction. They are severely, almost pedantically, simple, their proportions are good, and Kent avoided the heavy-handed touch which spoils the work of some of his contemporaries. Probably the best piece of work that Kent ever did is the

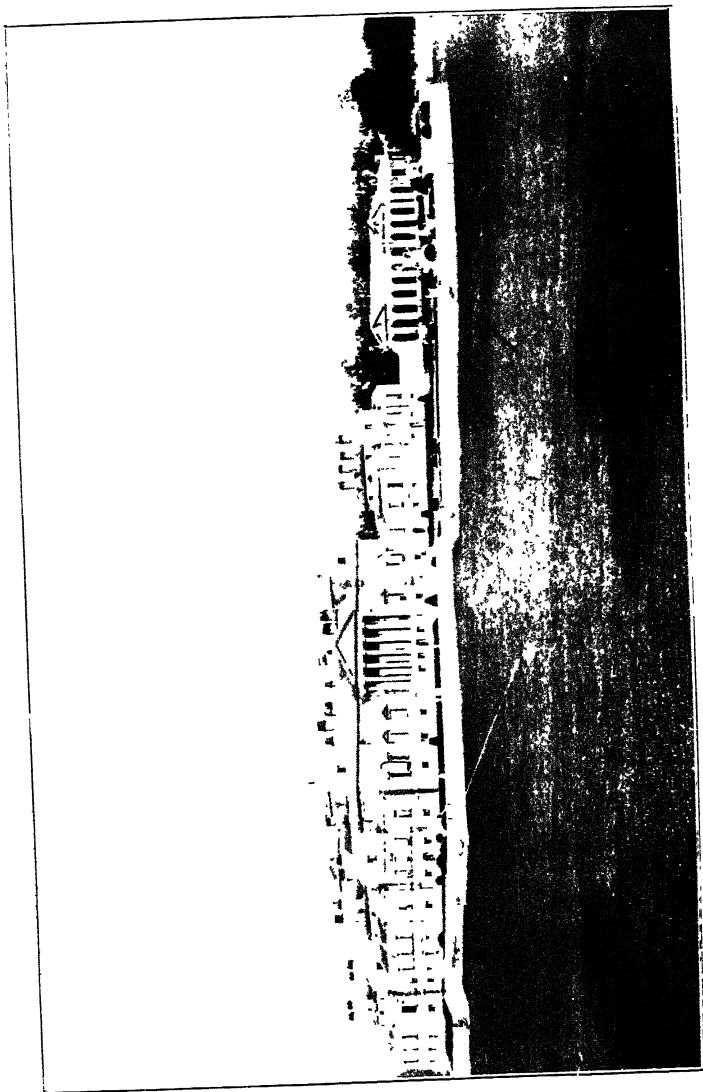

P. 170.

HOLKHAM HOUSE, NORFOLK.
(BY WILLIAM KENT.)

H. Applegate, photo.

temple of "Ancient Virtue" in the Gardens of Stowe, a circular room with a peristyle of the Ionic order; and the best examples of his manner are the façade of the Treasury Buildings to St. James's Park, 1734; Holkham in Norfolk; Devonshire House, Piccadilly, built in 1734; the Horse Guards, begun in 1742; and the interiors of the Earl of Yarborough's house in Arlington Street, and of the Earl of Powys' house in Berkeley Square. Both of these houses show a very skilful treatment of the long narrow London site. Devonshire House has been spoilt by later alterations. Holkham, though unattractive, is at least original. The general plan consists of a rectangular block containing the principal rooms, with four smaller detached blocks connected by passages at the angles with the main block. The north front has a monotonous repetition of Venetian windows, both fronts are overburdened by the expanse of bare wall above the windows to the principal floor, and the wings are curiously ugly.

Kent was more successful with the Horse Guards, one of the best Palladian designs of the eighteenth century; its only fault is a possible affectation of size not borne out by the scale of the actual building, but its grouping is good, and in spite of the baldness of detail, the general outline is picturesque. Curiously enough, this building is one of the latest of Kent's designs. It was not completed at the time of his death, and was finished by Vardy. Its manner is intended for Palladianism in its most rigorous development; yet, at the same time, Kent was making barbarous designs in what he supposed to be the Gothic manner, which are remarkable only for their ignorance of Gothic, and the total disregard of the restraint necessary to any architectural design whatever. Various instances will be found in "Some designs by Mr. Inigo Jones and Mr. Wm. Kent," published by Vardy in 1744; these designs show not the slightest knowledge of Gothic architecture, and little or no regard for the materials in which they were to be executed. A designer who could permit himself such folly as this is hardly to be taken seriously; and though Kent, as he showed at the Horse Guards, Devonshire House, and elsewhere, had capacity as a designer, he was not a man of strong convictions. He evidently did not believe in his own work, but was prepared to design in any manner that satisfied the fashion of his time. Though capable of designing fair Palladian architecture, he was

equally ready to turn out some of the most barbarous versions of Gothic ever perpetrated in this country, for no other reason than that the *virtuosi* were already becoming interested in experiments in Gothic architecture and regarded it as a favourable field for their artistic efforts. In the same way, Kent, though acquainted with the fine tradition of garden design, of which Bridgeman was almost the last exponent, threw over this tradition, and set himself to lay out gardens and grounds with studied disregard of the building which must in any case give the grounds their *raison d'être*. In his eclecticism (in this regard only another term for absence of artistic conviction) Kent anticipated one of the worst tendencies of modern English architecture. He was not bound by the tradition of the long line of able English architects who had preceded him; he did not even follow the scholastic pedantry of Campbell, who at least had knowledge of his art. Nor again had he any distinctive individuality of his own, such as Vanbrugh and Hawksmoor undoubtedly possessed. The key to his variations of manner is to be found in the fashion of the time. Kent was the obedient servant of his public, and his public appears to have been rather frivolous and very ignorant.

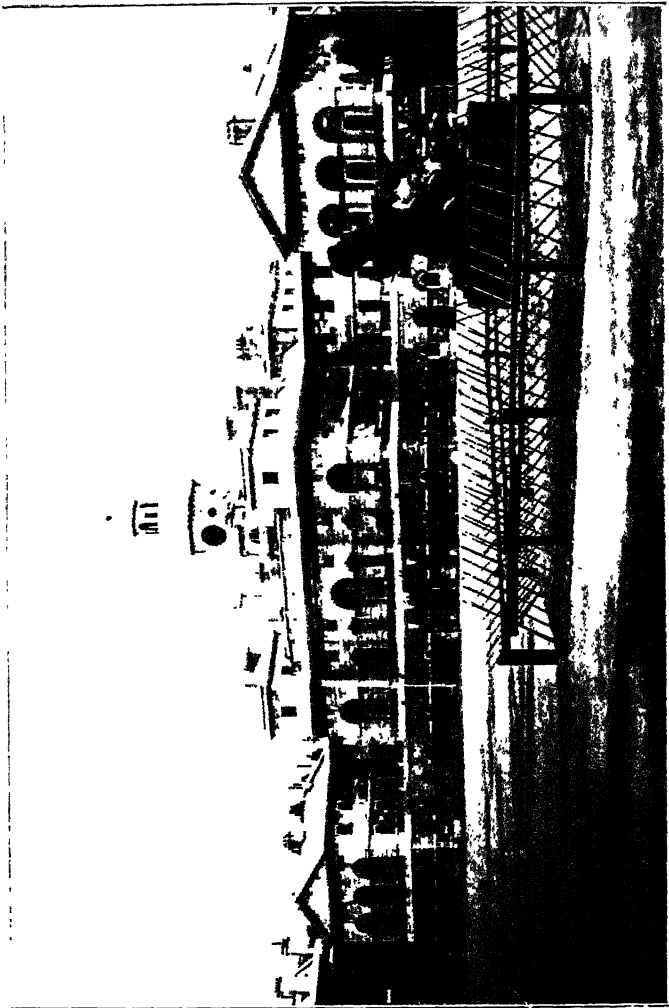

Wilson, Aberdeen, photo.

CHAPTER X

GIBBS, WARE, FLITCROFT, VARDY, THE WOODS OF BATH, DANCE THE ELDER

FOR chronological reasons, and on account of their association with Lord Burlington and with each other in various works, it has been necessary to deal with Campbell, Ripley, and Kent before giving an account of Gibbs. Gibbs, however, is in every way a more important figure in the history of English architecture, and to a certain extent occupies an independent position. He owed nothing to the somewhat overpowering patronage of Lord Burlington, and in much of his work he definitely resumed the tradition of Wren, herein parting company with his contemporaries, who showed no disposition to follow Wren's lead.

The materials for an account of Gibbs are very scanty, and consist mainly of the volumes which Gibbs published himself of his own works, and a MS. in the Soane Museum, entitled "A Few Short Remarks on Some of the Finest Ancient and Modern Buildings in Rome and Other Parts of Italy, by Mr Gibbs," etc., made for his own use about 1707, followed by a short account of Gibbs, apparently by some one who knew him well. James Gibbs was born in Aberdeenshire in 1682, and was the younger son of a respectable family. He travelled to Holland, thence to Paris, and finally to Rome, where he studied under C. Fontana the younger, a pupil of Bernini, and probably became known as a draughtsman to the various English noblemen visiting Rome. On his return to England in 1709 he was helped by the Duke of Argyll, Lord Mar, Wren, and others, and was appointed one of the surveyors to the commission appointed by the Act of 1708 to build fifty churches. In this capacity he designed the Church of St. Mary-le-Strand, 1714-17. Gibbs says that this was the first

public building he was employed on after his return from Italy, "which being situated in a very publick place, the Commissioners for building the fifty Churches (of which this is one) spared no cost to beautify it." Gibbs's original idea had been to have a small campanile to the church, and at 80 ft. westwards a column 250 ft. high, in honour of Queen Anne. His design was approved, and the stone brought on to the site. But before this was built Queen Anne died, the idea was given up, and Gibbs was ordered to design a steeple instead of the campanile, in spite of the fact that the building was already 20 ft. up on the original plan, and "therefore admitting of no alteration from east to west, which was only 14 ft.," that is, the square of the original campanile. Gibbs was accordingly obliged to spread the tower from south to north, "which makes the plan oblong which should have been square." He got over the difficulty by a most skilful use of detached pillars on the north and south sides, and engaged pilasters on the east and west. All the details of this church show extreme care and thoughtfulness, but they are somewhat overcrowded, and the design, as a whole, is wanting in breadth and simplicity. Campbell's remarks on the "trifling, licentious, and insignificant ornaments, so much affected by some of our moderns," and various other abuses in architecture, probably refer to this Church of St. Mary-le-Strand, recently completed, and, in spite of their snappish temper, have rather more reason than most of his criticisms. In 1719 Gibbs completed the steeple of St. Clement Danes from the entablature below the clock upwards, and in 1721 he was employed to design the Church of St. Martin-in-the-Fields, on the whole the finest of his works.

Gibbs made two designs for this church. The first was for a circular church, 95 ft. in diameter, which he preferred himself, but which was rejected by the commissioners on the ground of expense; the other design is the one actually carried out, at a cost of £32,000, between 1721 and 1726. The interior consists of a nave with an elliptical ceiling, and side aisles with shallow domes over each bay. The plaster work was executed by Gibbs's favourite Italians, Signori Artari and Bagutti. It is an effective interior in Wren's manner, and very well adapted for its purpose. Fergusson criticises the portions of the entablature over the detached columns, and makes the ridiculous suggestion that they would be better upside down.



ST. MARY-LE-STRAND.

Fergusson was not a practical architect or he would have seen the futility of his suggestion. The extreme projection of the cornice of the entablature when reversed above the abacus of the capital would be perfectly absurd. The question, however, of the use of detached portions of an entablature above columns in cases of this sort is one of considerable technical difficulty. Their use seems unreasonable, and the straightforward simplicity of arcades such as those in the church of St. Catherine Cree is more satisfactory from every point of view. But it may also be desirable to introduce a complete entablature in an interior for purposes of architectural effect, and if the church has a nave and aisles separated by detached columns, either the entablature will not work out, or it has to be treated as Gibbs treated it in St. Martin's-in-the-Fields. The solution to this problem seems to be to abandon not the entablature, but the arcade, and to treat the entablature as a lintel, either from column to column, as at Christ Church, Newgate Street, or from the column to the outer walls of the aisle, as at St. James's, Piccadilly. In both of these churches the use of the entablature is justified on constructive grounds, and it is noticeable that where Wren omitted the entablature and brought the plaster groining right down on the top of the abacus, as at St. Andrew's by the Wardrobe, the effect is barren and almost mean.

The exterior of St. Martin's is very boldly designed. The single order is more effective than the double order of St. Mary-le-Strand, and the great spire and portico at the west end form a composition not unworthy of Wren himself. Fergusson is again severe in his condemnation. The spire he allows to be "in itself not objectionable; but not only," he says, "does it appear unmeaningly stuck through the roof, but over so open a portico has a most crushing and inharmonious effect;" and, with his usual facility in improving the designs of distinguished architects, he suggested that the spire should have been placed alongside. The answer is simple: that such was not Gibbs's intention, and that he was attempting another problem, namely, that of combining a steeple with a portico. Gibbs, a master in the designing of spires and steeples scarcely inferior to Wren himself, knew perfectly well what was required in a spire. To Plate XXXI. of his "Book of Architecture" he wrote, "steeples are indeed of a Gothic extraction, but they have their beauties when their parts are well disposed, and

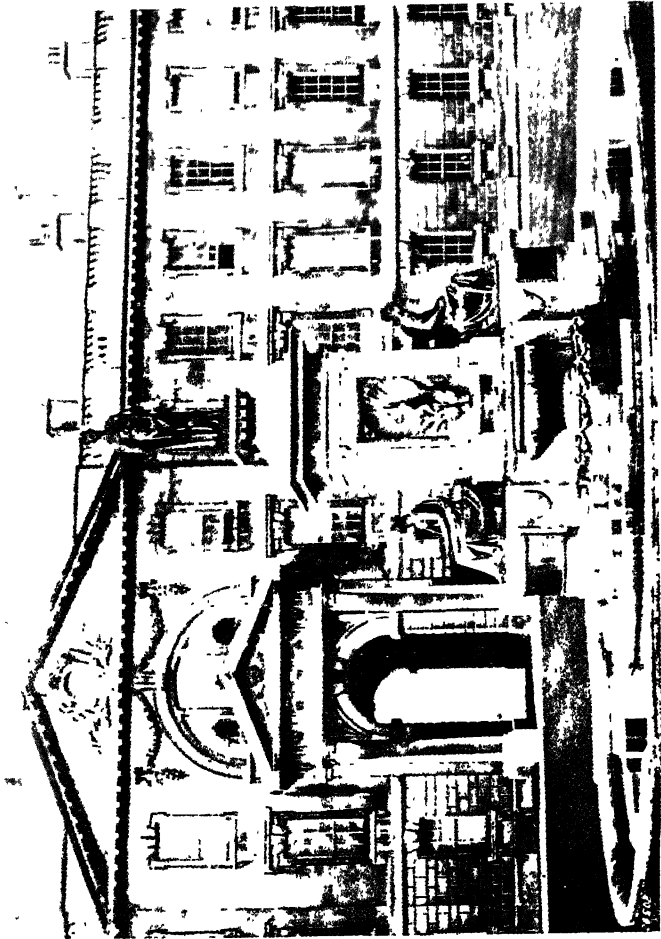

Firth & Co. Photo.

KING'S COLLEGE, CAMBRIDGE.

K. 111.

when the plans of the several degrees and orders of which they are composed gradually diminish and pass from one form to another without confusion, and when every part has the appearance of a proper bearing." Gibbs was aware of the necessity of satisfying the eye as to constructive stability, and it is evident that he was fully conscious of what he was doing in placing his steeple where he did. From north-west and south-west, the points of view from which alone the composition of the steeple with the portico can be judged, the steeple stands fairly and squarely on its base. Moreover, it does not stand "over the portico," as is stated by Fergusson, who wrote on somewhat cursory impressions of buildings, but at the back of it; that is, the west wall of the tower is part of the solid wall at the back of the portico, and therefore the openness of the portico has nothing to do with the question. Fergusson's criticism is too hasty. The phrase "stuck through the roof" might be technically correct if applied to a mediæval *flèche*, though it is a term that begs the question. In the case of a tower and steeple, such as that of St. Martin's, the phrase is inexact and misleading, as is his expression of "astride of the roof." The roof is a flat-pitched roof, partially concealed by the balustrade, and only visible at a distance.

In 1721-24 Gibbs designed St. Peter's, Vere Street, and in 1725 the nave of All Hallow's Church, Derby. From 1722 onwards Gibbs was constantly employed at Cambridge. In this year he designed the Senate House, which was intended to form the right-hand block of a three-sided court, of which the Royal Library was to occupy the centre, and the Consistory and Register Office the left-hand side. The Senate House was finished in 1730, Artari and Bagutti being again employed on the plaster work. The rest of the scheme was not carried out, possibly on account of the acrimonious division of opinion as to whether the three sides were to be attached or detached at the angles. The library was ultimately built from a design by Wright, 1754-58. In 1723 Gibbs was called in to design the new buildings at King's, Cambridge. A design and a model for this had already been obtained in 1713-14 by Adams, the provost. This design was made by Hawksmoor, acting under Wren's supervision, but nothing was done; and when Adams died, in 1719, Hawksmoor's scheme was dropped. Gibbs's design consisted of a quadrangle, 240 ft. by 282 ft., of which

one side was already occupied by the chapel. Each side was detached with a free space of 20 ft. at the angles, Gibbs giving as his reasons (1) that his buildings were different in style from the chapel, and (2) that the plan would diminish the risk of fire. The west side only was completed, and in 1824 the college resolved to complete the quadrangle and to Gothicize Gibbs's buildings. The south side, and the screen on the east side, were built from designs by Wilkin at a cost of about £100,000. Fortunately, however, Gibbs's block was left intact.

By a curious coincidence Gibbs again superseded Hawksmoor at Oxford. When Dr. Radcliffe left his bequest to the university, Hawksmoor prepared the first design for the library. His design was not adopted, and the building was begun from a design by Gibbs in 1737 and completed in 1747. Gibbs probably considered this building his most important work. He published a complete set of the drawings in the "Bibliotheca Radcliviana" in 1747, and no expense was spared in the execution of the work. The design consists of a great rotunda with a rusticated plinth, above which are sixteen pairs of engaged Corinthian columns, carrying a continuous entablature and a balustrade with pedestals and urns above the columns. The great sweep of the unbroken entablature, and the largeness of conception displayed throughout this building, show that Gibbs, at his best, had some of Wren's happy faculty of designing in the grand manner. Set back a distance of 17 ft. 6 in. from this balustrade comes an upper circular storey which forms the drum of the dome. This storey has eight buttresses 5 ft. thick, with a cornice, pedestal or blocking course, and urns above the buttresses; and above the blocking course springs the dome with eight ribs, surmounted by a small lantern and cupola with a great copper finial ball. The buttresses to the drum of the dome come between the pedestals above the lower order, instead of opposite them; a bold variation on conventional design fully justified in perspective.

Gibbs's inferiority to Wren is evident in the interior of the building. The drum of the dome starts from an unbroken entablature on modillions, and the arcade under this entablature is circular in plan, with the result that the arches are in-winding, and the mitres to the returns of the entablature are violently exaggerated. Moreover, the pilasters to the drum of the dome are out of proportion to the small Ionic order of the arcade



Wilson, Aberdeen, photo.

P. 184.

RADCLIFFE LIBRARY, OXFORD.

(BY JAMES GIBBS.)

below; and Artari's plaster work is rococo and florid to the last degree. Gibbs had a great admiration for the "fretwork" of Artari and Bagutti, which reflects little credit on his taste, whereas he seems to have taken for granted the admirable architectural carving both in wood and stone which he could always command in English workmen. Wren's influence is evident in the general design of the Radcliffe, and it is probable that Gibbs took his idea from Wren's design for the mausoleum to Charles I.

Of Gibbs's domestic work the most important examples are Ditchley in Oxfordshire, built for Lord Litchfield, and Milton House near Peterborough, for Lord Fitzwilliam. The plans, which are given in Gibbs's "Book of Architecture," show the disregard of comfort usual in eighteenth-century planning, but on the other hand, for purposes of display, they are fully as effective as the plans of Campbell and James. Gibbs was extensively employed in designing additions and alterations to houses in and about London, as at Twickenham for Mr. Secretary Johnson and Mr. C. Ogle, and at Isleworth for Sir John Chester, and for pavilions and temples in parks, as at Hackwood and Stowe. The description of the pavilion which he designed for Sir John Cooper near Derby is typical, "a cube of 20 feet, adorned with 3 Venetian windows, circular niches for Bustos, and an entablature supported by Rustick coines." No gentleman's place in fact was considered complete without a temple adorned with Bustos, entablatures, and "rustic coines." In 1730 Gibbs designed the quadrangle of St. Bartholomew's, Smithfield, probably with the Westminster dormitory, the earliest instance of the use of Bath stone in London. In 1733 he published a series of sixty-four plates with letterpress, entitled "Rules for drawing the several parts of Architecture," a complete manual of instruction in architectural design, which must have had much influence on the architecture of the time, and been invaluable as a pattern-book to builders and amateurs. Gibbs was probably the most learned architect of his time, and his learning was at once his strength and his weakness, for if it saved him from errors of scholarship (from which indeed Wren was not exempt), it also hampered his invention and led him to substitute knowledge for thought. He did not attempt new combinations. Unlike Hawksmoor, he shrank from those bold experiments which are perhaps impossible of attainment, and

yet from their individuality and courage will always be more attractive than the commonplaces of design.

Gibbs's "Book of Architecture" (1728) contains his various designs for monuments at Westminster Abbey, Bristol, Bolsover, and Warwick. The Duke of Newcastle's is perhaps the best, but Gibbs's natural taste in ornament seems to have been poor. His interest in decorative design was academical, that is to say, he was content to reproduce the accepted ornament of his time without any attempt on his own part to design ornament for a specific purpose and with a specific meaning. In this regard his art was barren, and no further developments could grow out of it. His real superiority to the other architects of his time lay in the proper province of architecture, in the power, that is, of considering his building as a whole, and as an affair of large planes and masses, and of carrying it through to completion without failure in scale, or lapses into insignificance. No other English architect since the beginning of the eighteenth century has met Wren on equal terms on his own ground, as Gibbs did in his Church of St. Martin-in-the-Fields. Gibbs died in 1754, and with him the last trace of Wren's tradition in official architecture.

Yet the eighteenth century has a remarkable record in architecture. Though Gibbs stood by himself, Isaac Ware, Wood of Bath, and even Flitcroft, were not inferior to Campbell and Ripley, and behind these again stood architects of undoubted ability, such as Vardy and Paine, and Chambers, the last and stoutest champion of the older school. Ware was a voluminous writer as well as an architect. In 1735 he published plates of Houghton Hall with Ripley and Kent, and of Rookby Hall in Yorkshire, and in the same year fifty-three plates of designs by Inigo Jones and others, a work of small value, and very inaccurate in regard to the work of Inigo Jones. In 1737 he published designs for the Mansion House, and in 1738 a translation of the four books of "Palladio." In 1756 he published a translation of Sirrigatti's practice of perspective, and an important manual of architecture, under the title of "A Complete Body of Architecture." It is not known how Ware was educated. The story is that he was the son of a chimney-sweep, and that, having been seen by a gentleman drawing before Whitehall, he was sent by this unknown patron to Italy, early in the eighteenth century. In 1728 he was appointed clerk of the works at the

Tower, in 1729 clerk of the works at Windsor Castle, in 1735 draughtsman and clerk itinerant to H.M. Board of Works at Windsor and Greenwich. In 1733 he carried out some work at Laneborough House, on the site now occupied by St. George's Hospital; in 1749 he designed Chesterfield House, and he also made designs for Chicksand (1750) and Wrotham Park in Middlesex, 1754. The Town Hall at Oxford, recently destroyed, was designed by Ware in 1754. He died in 1766. Chesterfield House, Mayfair, is the best-known example of Ware's work. It had the usual arrangement of advanced wings on either side of the forecourt, with the main block in the centre, and the colonnades were rectangular, a variation on the usual quadrant. The main block is in three storeys, simply treated, but of good proportion, and the details, as in all Ware's work, are well-designed and vigorous. The house, as it now stands, varies considerably from the original design, for the sides of the forecourt have been taken down and rebuilt. The design is thus very seriously mutilated, and no idea can be formed, from the house in its present state, of what its complete effect must have been, when the wings were standing, detached from the main block by the colonnade, and yet designed in subordination to it in scale, and with the clear intention of acting as a foil to the main block.

Ware's sympathies were evidently with his predecessors rather than with the rising school of the brothers Adam, and there is no trace in his work of the somewhat finikin manner of the latter. He was extensively employed in private houses in London, and did work in South Audley Street, Burlington Gardens, Dover Street, Bruton Street, Hanover Square, Berkeley Square, and Albemarle Street, illustrations of which are to be found in his "Body of Architecture." One of the best examples of his manner is the house, No. 6, Bloomsbury Square, in which he died, and probably the adjacent house at the corner of Hart Street. Ware was a very able architect, especially in house-building, and his reputation has been undeservedly thrust into the background, partly owing to the brilliant success of the brothers Adam and Chambers, and partly owing to the change of taste which was losing touch of tradition and drifting away into a merely capricious eclecticism.

Flitcroft and Vardy were contemporaries of Isaac Ware, and

Flitcroft at any rate enjoyed a distinguished reputation in his lifetime. His career is characteristic of the eighteenth century. He was born in 1697, and in 1711 was apprenticed for seven years to a joiner. While working as a carpenter in Lord Burlington's house, 1717-18, he attracted the notice of his lordship by breaking his leg, and from this time forward enjoyed the favour of Lord Burlington, who, whatever his merits as an architect, was certainly a generous patron. Flitcroft was employed as a draughtsman in Kent's publication of "Designs of Inigo Jones," and appears to have prepared all the drawings for that work for Hulsbergh and Fourdrinier to engrave. In 1726 he was appointed clerk of the works at Whitehall and St. James's, and in the years following he held various official posts, succeeding Kent as master mason in 1748, and Ripley as controller of his majesty's works in England, on the death of the latter in 1758. Flitcroft held this appointment till his death in 1769. His earliest important work was the Church of St. Giles-in-the-Fields, 1731-33, a design of no great originality, in which Flitcroft followed, not very successfully, the precedent set by Wren and Gibbs. Flitcroft also designed the Church of St. Olave, Tooley Street, in 1737-39, and the Church of St. John, Hampstead, in 1745-47. His chief domestic works were Wentworth House in Yorkshire, built in 1740, and Woburn Abbey in Bedfordshire, 1747. Flitcroft published a large double-page engraving of his design for Wentworth House at the end of Kent's folio of drawings by Inigo Jones. Whether any part of this was carried out I do not know, but the building in its present state differs materially from the original design. As shown in the original design on Flitcroft's engraving, Wentworth House had a total frontage of 600 feet, consisting of a large central block with a hexastyle portico the full height of the building. This central block was raised one storey above the adjacent wings. To the right and left of these wings came lower blocks of buildings on a different scale, terminating in convex screen walls and square towers or pavilions at the end. The abrupt change in scale shown in this design is unsatisfactory. Flitcroft seems to have designed this building piecemeal, or rather to have pieced it together from other designs, for the great central block is a reproduction with slight variations of Campbell's second design for Sir Richard Child at Wanstead; and Flitcroft has here introduced the spreading pediment, first used in England to any

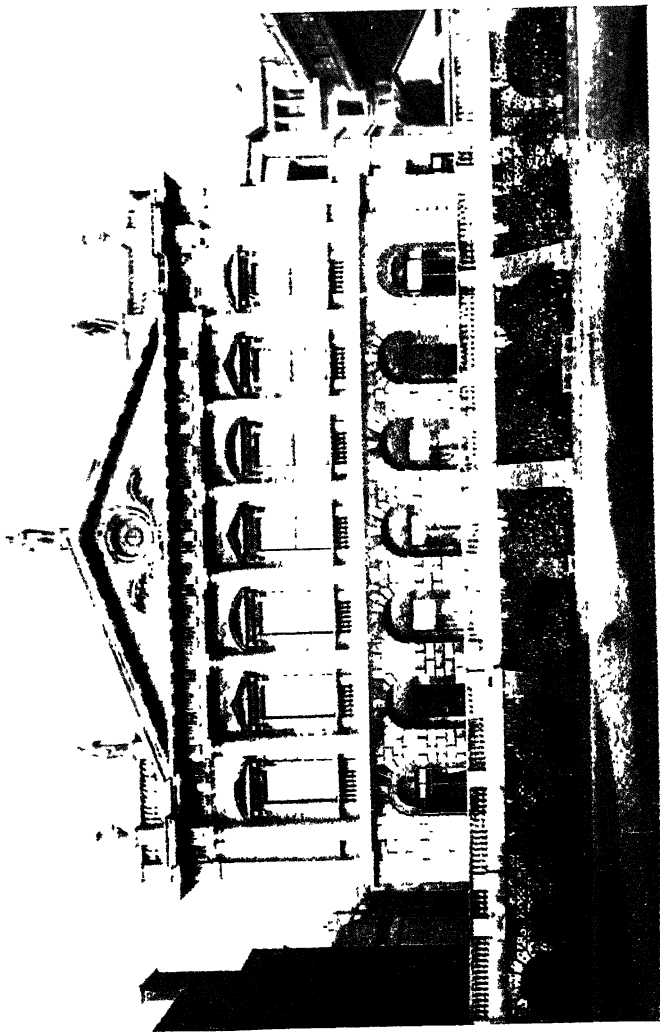

great extent by Campbell. This pediment covers a two-storey façade, of which the width is exactly three times the height. Woburn Abbey was practically rebuilt by Flitcroft in 1747, and this may perhaps account for the quadrangular plan, which reverts to the rudimentary method of rooms ranged side by side in single thickness, with a corridor running past them on the side to the court. Flitcroft's early training at the bench was no doubt invaluable on its practical side, but hardly adequate to refine and strengthen a rather dull imagination. All his designs suggest the builder's draughtsman rather than the architect.

Of John Vardy, his contemporary, little is known. He was a pupil and assistant of Kent's, and worked with the latter on the Law Court buildings at Westminster, and also at Whitehall. After Kent's death he completed the façade of the Horse Guards towards Whitehall, and designed the Court of King's Bench at Westminster in 1753. In 1762 he designed Lord Spencer's house, overlooking the Green Park. The plan is remarkably able, and in the ingenuity of its arrangement more modern than any plan of the time. Separate access is given to every room, and each room has a sidelight of its own from the open air, instead of having to depend on toplights, or borrowed lights from halls and staircases, as in so many of the designs of this period. The façade facing the park has a rusticated ground storey, and above this engaged columns in seven bays, with an entablature of the Doric order, and a pediment over the five centre bays. The columns are spread very wide apart, about four diameters, and this excessive width of the intercolumniations, together with the spreading pediment, makes the building look lower than it is. This façade, however, is a fine composition, and except that the balusters are rather slight and overcrowded, the scale is well maintained. The north façade, facing the street, is much less successful. In justice to Vardy, however, it must be pointed out that this façade was never completed, as Vardy intended the projecting bay at the end, with its Venetian window, pilasters, and pediment on the first floor, to be repeated at the other end, and it is so shown in the "Vitruvius Britannicus," iv. 38. This second bay, however, was never built, and the single pilaster built to start it still further emphasizes its incompleteness. Vardy died in 1765. His only published work, "Some Designs by Mr. Inigo Jones and Mr. Wm. Kent," appeared in 1744. It includes

some very bad designs, some of which are certainly by John Webb; and the thirty-three designs by Mr. William Kent range from the Court of King's Bench to a candlestick and two dish-covers. Vardy appears to have possessed capacity as an architect, but his taste was indifferent and the range of his imagination limited.

Wood of Bath is in every way a more interesting figure. He was born in Yorkshire, and began his career at Bath as a road surveyor in 1727. Till his death, in 1754, he was extensively employed in Bath and the neighbourhood, and the modern city of Bath owes all its finest qualities to John Wood and his son and the generous enterprise of Ralph Allen. Wood's earliest works in Bath appear to have been the Chapel court and church buildings in Bath; Eagle House, Bathford, in 1727; St. John's Hospital in 1728, and the north side of Queen's Square, begun in 1729. In the last, and also in his designs for the Circus, and North and South Parade, Wood combined the several houses into one architectural design. He had, from the first, a strong sense of composition, and seems to have grasped the fact that to attain any dignity in a city it is not enough to put up picturesque buildings and to leave the arrangements of streets and squares to the exigencies of commerce. He saw the necessity of a far-seeing scheme which should bring important buildings into relation to each other by a wise generosity in open spaces and ample streets; and by singular good fortune he was able to lay his lines so surely as to leave Bath, as it is to this day, the finest city in England. Wood's actual buildings in Bath are disappointing. They are rather small and almost weak in design, and not particularly refined in detail, and his best work is to be found in the magnificent house which he built for Ralph Allen at Prior Park. Something of the effect of this house is no doubt due to the site at the head of a beautiful valley, but it was one of Wood's particular qualities that he had a keen eye for the possibilities of a site, and by taking full advantage of the natural fall of the ground at Prior Park, he succeeded in producing a façade which is unsurpassed in England in its dignity and distinction. Wood carried out several other important works at Bath and in the neighbourhood, including the Exchange at Bristol, Redland Court and the Exchange at Liverpool, on which he was occupied at the time of his death. His son, John Wood, junior, carried

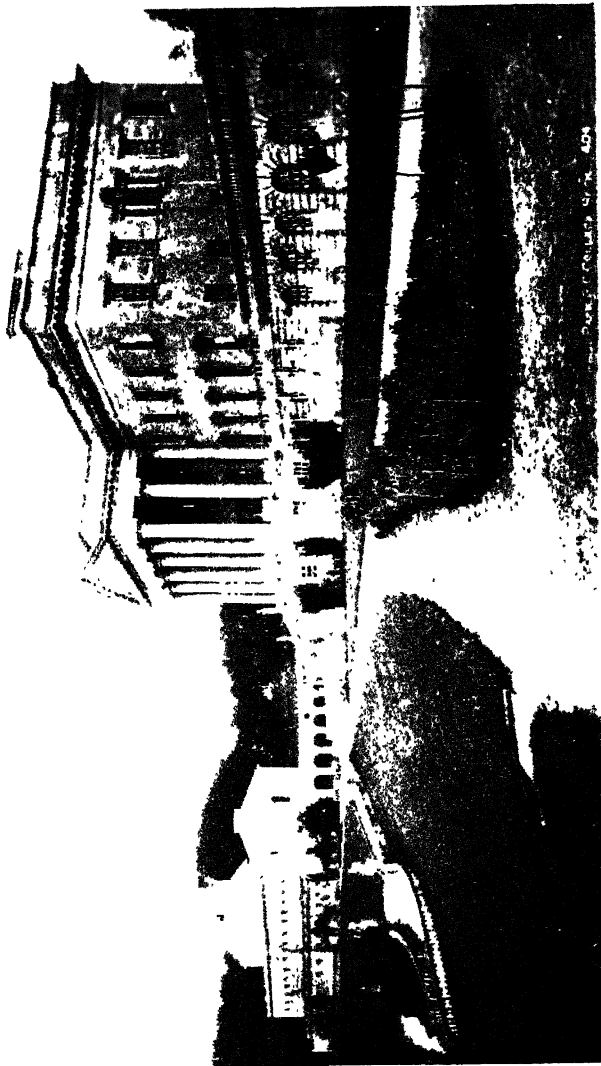

Wilson, Aberdeen, photo.

out his father's work and completed the Circus and Gay Street at Bath. In 1769-71 he designed the Royal Crescent, which is elliptical in plan, and the New Assembly Rooms; and between the years 1757-71 Buckland in Berkshire and Standlynch in Wiltshire were built from his designs. Young Wood died in 1782. Apart from their capacity as architects (and that of the elder Wood was very great) both men are interesting as illustrating the state of architecture in the country in about the middle of the last century. Both the Woods were provincial architects, and so far as is known, were not in touch with the brilliant architects then practising in London, yet their manner of design is hardly to be distinguished from that of the latter, and there is no suggestion of the technical inferiority in design which has to some extent characterized the work of provincial architects since their date. Carr of York is another instance. The explanation is to be found in the unhesitating adhesion which all these men gave to one specific manner of design. Every architect was expected as a matter of course to be thoroughly grounded in the details of Palladian architecture, and for the first fifty years of the eighteenth century it never occurred to an English architect to design in any other manner. The result might be a certain tameness and monotony, but it at least preserved architecture from the vulgarities of unmitigated ignorance.

George Dance the elder is an instance of the value of this tradition. Born in 1698, he was appointed "Clerk of the City Works" by the Corporation in 1733, and from this date till his death, in 1768, he was employed on various buildings in and about the city, notably the Mansion House, begun in 1739 and completed in 1753. Dance was certainly not a gifted, or even a learned architect, yet the vitality of the tradition under which he worked was strong enough to save him from gross errors of taste, and even to impress a certain dignity on the work of a man of very moderate natural abilities, who was said to have begun his career as a shipwright. The Mansion House, which is his most important work, has its faults, and its details are very bad. Yet Dance's design is not deficient in a certain robust energy: it loses nothing by comparison with the adjacent buildings, such as the Bank of England and the Royal Exchange. The Mansion House occupies an oblong rectangular site, with 100 ft. frontage, and extending southwards 225 ft. The prin-

cipal floor consists of an entrance hall leading into two salons placed *en suite* and communicating with the Egyptian Hall, 90 ft. by 59 ft., at the back of the building. Rooms are arranged on either side of the entrance hall and salons. The front elevation consists of a basement storey supporting a Corinthian order with an attic storey and balustrade over, and a projecting portico in five bays in the centre. As originally built there was another storey constructed on the roof over the front block and over the Egyptian Hall, giving a total height of 101 ft. The south storey was removed by the younger Dance in 1796, and the front in 1842, very much to the advantage of the design, for these extraordinary attic storeys must have gone far to justify the hostile criticism which this building has invariably encountered.

Dance's churches are unequal. His earliest work was St. Luke's, Old Street, begun in 1732. This was followed, 1736-40, by St. Leonard's, Shoreditch; St. Matthias', Bethnal Green, in 1741; St. Botolph, Aldgate, 1749-50; and some additions to Maversham Church in 1754. Of these churches, that of St. Leonard's, Shoreditch, is the most successful. St. Botolph, Aldgate, is bald even to brutality, but in St. Leonard's Dance caught a reflection of Wren's most admirable manner, and, in fact, must have consciously borrowed from St. Mary-le-Bow. The outlines of the two steeples are not very dissimilar, but in every case where Dance ventured on a new departure of his own he has lost the grace of the original; and though the tower is picturesque in outline and soundly constructed, it fails of attainment in the precise point at which Wren was so eminently successful. In Dance's design there is no cohesion between the lower stage, the tower, that is, and the steeple over it. Where Wren kept his tower square and comparatively plain, and softened the transition from the round to the square with curious but most effective terminals, Dance has broken up the mass of his tower with engaged columns, and left the angles over them empty, except for some clumsy brackets which are quite inadequate to complete the outline.

Flitcroft, Dance, and Isaac Ware perhaps represent the last of the older school of eighteenth-century architects. The transition is fine and in some cases barely perceptible, yet I think a distinction may fairly be made between the generation which succeeded Wren, and which had more or less ceased to exist

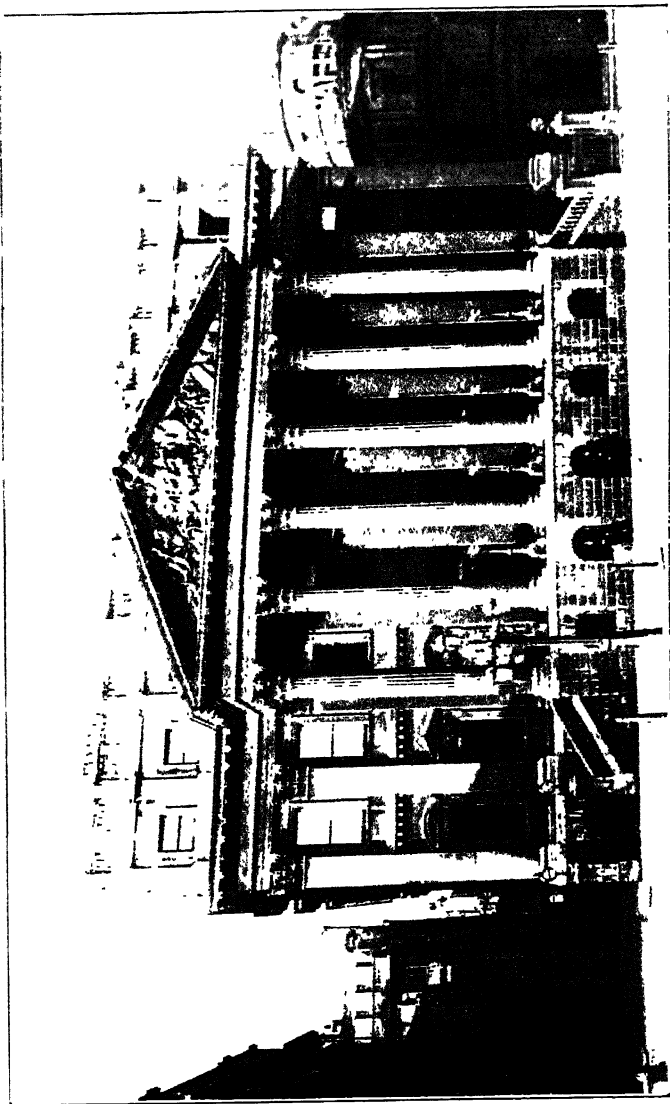

Wilson, Aberdeen, photo

THE MANSION HOUSE, LONDON.



ST. LEONARD'S SHOREDITCH.

by the second half of the eighteenth century, and the next generation represented by Carr of York, the younger Dance, and Chambers on the one hand, and the Adams on the other, Paine, perhaps, presenting the exact point of transition between the two. John James died in 1746, Gibbs in 1754, Vardy in 1765, Ware in 1766, and Flitcroft in 1769. All these men followed the tradition of Inigo Jones, their architecture at its best was severe, almost forbidding in its grave abstention from ornament, and it adhered steadily to its precept in being "masculine and unaffected." Their immediate successors divided into two camps, represented on the one hand by Chambers, who, to all intents, belonged to the older school, and on the other, by the brothers Adam, and the innovators who endeavoured to refine upon the old tradition by the introduction of Greek and other motives. With this latter school, the eclectics as one may call them, quite modern architecture with all its disastrous experiment begins. Whatever the merits of these men, the ideal of Inigo Jones was not the mark at which they aimed. Their work is often graceful and accomplished, refined in proportions, and dexterous in ornament, but it is feminine in quality and steeped in affectation. One looks in vain in their work for the energy of intelligence, the strong contempt for prettiness, which even the inferior masters of the older school possessed in some degree. The elegance of the Adams was but a poor substitute for this great quality. Their art was a morbid development, evidence of the slow decay that was surely overtaking the once magnificent school of English architecture.

CHAPTER XI

PAINE, MORRIS, TAYLOR, CARR OF YORK, CHAMBERS,
GANDON, DANCE THE YOUNGER, ROBERT AND JAMES ADAM

THE reputation of an artist is often an affair of accident. Though history rights itself in the long run, men have owed their eminence to fortunate circumstance, or adroit advertisement, and architects are more particularly liable to these caprices of fame, inasmuch as their works are stationary. Such a building, for instance, as the old Bethlehem Hospital, or the Town Hall at Abingdon, would not have disgraced the architect of Chelsea Hospital. Yet the names of their designers are unknown, and some of by no means the least attractive buildings of the eighteenth century are by unknown men. Few architects of the generation succeeding Ware and Flitcroft did better work than James Paine, yet in spite of his capacity and constant employment, his reputation has been overshadowed by that of Robert Adam, partly because the latter invented a method of decoration which caught on to the fashion of the time, and partly because Adam was astute in advertisement, and was perfectly disposed to recognize in himself a genius of first-rate order.

Paine was born in 1716; he is said to have studied in the St. Martin's Lane Academy for drawing, and in the introduction to his published works he says that he began his studies under Mr. Thomas Jersey. Paine was very early given important work to design. In the introduction to his folio on the Mansion House at Doncaster, he says, "Having at that time (1744) the honour to be engaged on several gentlemen's buildings in that county, I was made choice of for their architect." Answorth in Yorkshire, begun in 1740, and Heath House (1744-45) seem to have been his earliest buildings, followed by the Doncaster Mansion House (1745-48), Nostell

Priory (1751), Cowick Hall (1752), and Gosforth (1755) in Yorkshire, Dover House in Whitehall (1754-58), Serlby in Nottinghamshire, Stockeld in Yorkshire, and the stables at Chatsworth (1758-63). Between 1760 and 1770 Paine seems to have been engaged on nearly all the big houses then being built in England. In 1761 he prepared the first designs for Kedleston. The history of this house is singular; it appears that the original scheme had been furnished by Brettingham, from whose designs the north-east pavilion had already been built. Paine says that he adopted this design for the four pavilions or wings, but designed himself the central block and connecting corridors. For some reason the work was taken out of Paine's hands and given to the Adams, who carried out the plans with certain modifications, but the credit of the original design belongs to Paine. His account of it is that, finding himself too busy in other parts of England, he requested Lord Scarsdale to allow him to resign the work, "whereon it was intrusted to those able and vigorous artists, Messrs. Robert and James Adam." In 1761 the old Manor House at Worksop in Nottinghamshire was burnt to the ground, and in 1763 Paine was employed by the Duke of Norfolk to make designs for the rebuilding. Paine prepared plans on a magnificent scale. The general plan was quadrangular, about 305 ft. square, with two internal courts, divided from one another by the great Egyptian Hall, 140 ft. long by 70 ft. wide and 55 ft. high. The south entrance gave into a hall 40 ft. by 50 ft., from which visitors passed into the "Tribune," a circular hall, top-lighted, 40 ft. in diameter, with a peristyle of eight columns; thence to the Egyptian Hall, and from this again to the main staircase on the north side. By this arrangement a vista was provided through the entire depth of the building. The work was begun at once, but was stopped in the following year by the death of the Duchess, when only the north front was completed. In 1763 Paine designed Thorndon Hall in Essex for Lord Petre, and the house was begun in 1764 and finished 1769, in Portland stone and brick. For Lord Petre he also designed a very skilfully planned house on an irregular site in Park Lane. In 1770-76 he designed Wardour in Wiltshire, on much the same general scheme as Thorndon, with a centre block and advanced wings, but with a remarkable central hall 47 ft. in diameter, and 60 ft. high to the skylight, with a peristyle of the Corinthian

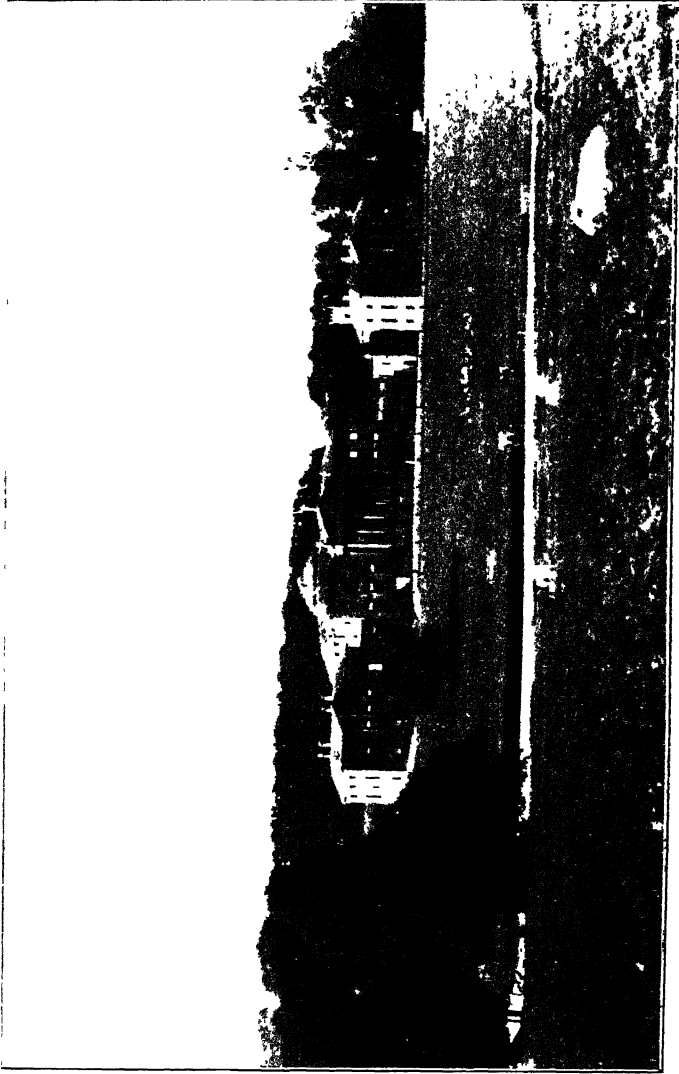

Keweenaw, photo.

order. Paine was rather fond of central staircases top-lighted; other instances occur at Axwell Park, Durham, Brocket Hall in Hertfordshire, and Gosforth. His latest works appear to have been Richmond Bridge (1780-83), bridges at Chertsey and Walton, and the beautiful bridge at Kew.

Paine was one of the most skilful house planners of the eighteenth century; his plans are, comparatively speaking, straightforward and convenient, and distinguished by a remark-

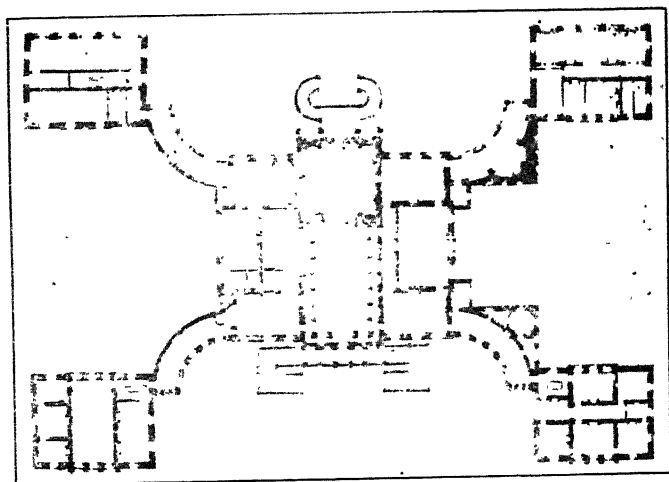

PLAN OF KEDLESTON.
("Vitruv. Brit." iv. 46.)

able ability in grouping, that is to say, Paine was quick to see the possibilities of any given combination, the chances it afforded of fine vistas and perspectives, and skilful in providing for these in his plans without obviously straining after effect. His strength lay in this power of abstract architectural design, that is, design which depends for its effect not on ornament, but on relations of mass and the play of light and shade; in a word, on the legitimate language of architecture pure and simple. In regard to his elevations and ornament, Paine was not so.

happy; his taste was doubtful, and he never developed any very decided manner of his own. The details of the Mansion House at Doncaster are coarse and commonplace. In Cowick Hall, another early work, with its pilasters and great overhanging cornice on modillions, he seems to have borrowed suggestions from some of Wakefield's houses, which were either designed or inspired by Vanbrugh. So again, in Serlby House, with its disproportionate pediments, he wavered between Archer and Ware; at Gosforth and elsewhere he seems to have caught from Kent a ridiculous mania for rows of finial balls ranged along the top of curtain walls, and he was by no means faithful to the orthodox Palladian tradition. The entablature to the front of Hare Hall in Essex is composed of a cornice and architrave with the frieze omitted, and the capitals to the angle pilasters of this façade show the hybrid details which Adam was rapidly making the fashion; while his ceilings abound in sphinxes, meaningless acanthus scrolls, and conventional stucco ornament. His best elevations were his plainest, such as the north fronts of Wardour and Thorndon, consisting of a rusticated basement and a plain façade, without either quoins or pilasters, and a simple cornice with a blocking course or balustrade above. Paine also designed Stapleton Park in Yorkshire, Shrubland Hall in Suffolk, buildings at Gibside, Bramham Park, and Forcet, and considerable alterations and additions at Cusworth in Yorkshire. He was one of the architects of the Board of Works, but lost this appointment after Burke's Reform Bill in 1782; and he was a member of the committee formed in 1755 to consider the organization of the Royal Academy, but on its formation in 1768 he was not elected a member, though in 1765 he had been chosen President of the Incorporated Society of Artists of Great Britain. Paine died in France in 1789, at the age of seventy-three, having outlasted the tradition under which he had learnt his art, and having lived to see the full development of that eclecticism against which, alike in practice and in writing, he had consistently protested.

His contemporary, Robert Morris, was more ambitious but less successful. Morris appears to have been born early in the eighteenth century, and was pupil to a kinsman, Roger Morris, principal engineer to the Board of Ordnance. His earliest work is said to have been Inverary Castle, begun in 1745 and finished 1761; this is a sort of Gothic, which is the more remarkable as

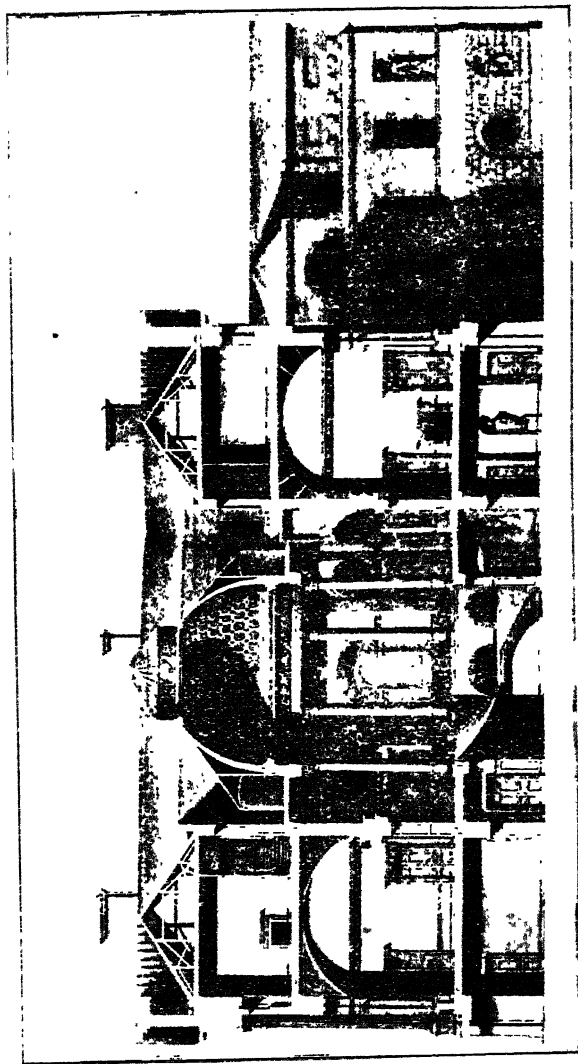

SECTION OF WARDOUR HOUSE, WILTS.
(J. Paine's, "Places, Elevations and Sections," ii. 404.)

Morris proposed to be a rigid purist in classical architecture, and realized his professions with the most complete ugliness in the central portion of the lodge built in Richmond Park for George II. ; and again in the house at Hammersmith, built for Thomas Wyndham, and afterwards called Brandenburgh House (destroyed 1822). Morris also designed a house for Lady Suffolk at Twickenham, Coom Bank in Kent, Wimbledon House (destroyed 1785), and Kirby Hall in Yorkshire. The gallery in Mr. Wyndham's house appears to have been his best piece of work ; this measured 85 ft. by 20 ft., and was sumptuously decorated with frescoes and gilding and rare marbles. Two of the columns were monoliths of Sicilian jasper, 17 ft. high, and the columns to the doorcase were of lapis lazuli.¹ Morris also designed the Palladian bridge at Wilton, and published various books on architecture. His work, however, is uninteresting. He was fond of covering his buildings with a great pyramidal roof, set at a very low angle, omitting all parapets or blocking courses ; and his originality is excessively dull. Morris is typical of the numerous architects of about the middle of the eighteenth century, who practised Palladian design with extreme assiduity and not a spark of genius. Sanderson, the architect of Kirtlington in Oxfordshire, a fine spacious design, and Stratton Park in Hants, the Hiorns, who designed Foremark in Derbyshire and the County Hall at Warwick, and S. Wright, who worked with Morris, were all men of much the same class and attainments.

In his memoir of the life of Sir Wm. Chambers, Gwilt says that Paine and Sir Robert Taylor "nearly divided the practice of the profession between them . . . till Mr. Robert Adam entered the lists." Taylor, who was the son of a stonemason, was born in 1714, and began his career as apprentice in the yard of Sir Henry Cheere, the sculptor. He visited Rome before the middle of the eighteenth century, and on his return to England was employed to carve the pediment to the Mansion House. The Mansion House was completed in 1753, and it appears that at about this date Taylor gave up sculpture for architecture. His earliest works seem to have been Stone Buildings in Lincoln's Inn Fields in 1756, and some alterations to Chilham

¹ In "Vitruvius Britannicus," vol. iv., pp. 28, 29, Servandoni is given as the architect, the probability being that Servandoni was called in to design the decorations.

in Kent. In 1759, in conjunction with Dance, the city surveyor, he designed the large central arch of old London Bridge, to take the place of two of the older arches; and from this time forward he was extensively employed on various banking houses in the city, on the old Bank of England, and on private houses, such as Gopsall Hall for Lord Howe, Ely House in Dover Street in 1772, Heveringham Hall in Suffolk, and on the building estates to which he was surveyor. He designed the bridge at Maidenhead in 1780. Taylor was architect to the Board of Works and surveyor to the Admiralty. He was knighted in 1782, and died in 1788, leaving the bulk of his large property as a legacy for the founding of the Taylorian institution at Oxford.

To Paine and Taylor, Gwilt should have added Carr of York, an architect who was extensively employed in the north of England between 1750 and the end of the century. Carr was born in 1723, and began as a working mason. Either as contractor or as clerk of the works, he built Kirby Hall in Yorkshire in 1750 from the designs of Morris, and shortly afterwards started in practice as an architect on his own account. No doubt his practical knowledge of masonry and construction gained him the confidence of his clients, for he was intrusted with designs of most costly country houses. In 1760 he designed Harewood House in Yorkshire, and in 1762 Tabley in Cheshire, with a frontage of 343 ft. Between 1751-64 he was building Lytham Hall in Lancashire, and in 1770 he designed the east front of Wentworth House, including the great gallery, 180 ft. long by 24 ft. wide and 30 ft. high. In 1776 he designed Basildon Park in Berkshire, the Town Hall of Newark, and the County Court House at York, and in 1778 Dunton Park. Carr also designed Thoresby Lodge, the Crescent at Buxton, and many large private houses. He was twice Mayor of York, and died in 1807 at the age of eighty-four. The most important of Carr's designs is Harewood House, decorated by Adam. The proportions of this house as built under Carr are correct, but there is nothing original about the design, and the most that can be said for it is that it is free from affectation and not particularly ugly.¹ Carr appears to have been a good practical architect, who was kept within

¹ Harewood was altered by Barry, and the original design has suffered severely from Barry's alterations.

reasonable limits of taste by a sound tradition and an abundance of excellent pattern-books.

The old tradition, however, was fast disappearing. The architects of the second half of the eighteenth century were convinced that theirs was one of the greatest eras of architecture that the world had ever seen. In the fullness of their pride they were no longer content with the old ways, but fell in with the prevailing dilettantism of the time, and met the rage for novelty with inaccurate versions of Greek architecture on the one hand and of Gothic on the other. The first volume of Stuart and Revett's "Athenian Antiquities" appeared in 1762. Gandon says, "On the appearance of Stuart's Athens there was a great sensation among the admirers of the fine arts, it grew into an almost mania for Greek architecture" (Mulvaney's "Life of Gandon," p. 197). Stuart at once became a fashionable architect and a sort of *arbiter elegantiarum* in matters of taste. Lord Anson got him appointed surveyor of Greenwich Hospital, in which capacity he rebuilt the interior of the chapel and left it a standing monument of all the faults of the style which he introduced. One distinguished architect alone resisted the fashion, and he, curiously enough, began his career in another calling, and became an architect in the face of his personal interests from pure enthusiasm for the art. Sir William Chambers was the son of a Yorkshire merchant settled at Stockholm. He was educated in Yorkshire, and was intended to follow his father's business, and with this object went out to the East Indies and to China as a supercargo, when he seems to have employed his time in making drawings of the buildings and gardens of the Chinese, and collecting the materials which he afterwards published in his "Dissertation on Oriental Gardening." On his return from the East, at the age of eighteen, Chambers definitely abandoned trade and went to France, where he worked for a time in Paris under Clerisseau; and thence to Italy, where he resided some years, studying architecture and making some slight reputation by his drawings among the *virtuosi*. Chambers's industry was unwearied, and he returned to England full of knowledge and an accomplished draughtsman, but an unknown man. His chance came to him through Carr of York. Lord Bute was anxious to find an artist to instruct the Prince of Wales (afterwards George III.), and asked Carr to name a suitable person. The latter recom-

mended Chambers, and Lord Bute introduced him to the prince. Chambers's earliest work was at Kew Gardens, where he designed a number of foolish pagodas, and also some temples and an orange house of excellent proportions and simplicity. Views of these buildings were published in 1763, but Chambers had already established his reputation by his treatise on "The Decorative Part of Civil Architecture," published in 1759, and on the accession of George III. he was appointed private architect to the king. In 1769 he succeeded Flitcroft as comptroller in the office of works. In 1768 he was made treasurer to the Royal Academy, and knighted in 1771 on the occasion of his receiving the Order of the Polar Star from the King of Sweden. In 1782 he succeeded Whitshed Keene as surveyor-general of the office of works. He died in 1796 and was buried in Westminster Abbey. Throughout his career Chambers was an exceedingly successful architect. It appears from the plates published at the end of his treatise on civil architecture in 1759, that he must have obtained employment before that date as a designer of triumphal archways and casinos. The entrance archway at Wilton is a good example. The casinos were ornamental buildings usually copied from some smaller Roman temple. They were placed in the grounds at some distance from the house, and intended in the smaller examples merely as an elaborate and costly summer-house, but in more important instances they contained sufficient accommodation for the owner and two or three servants. The first academical exercise of every young architect in the latter part of the eighteenth century was the design of a casino, and no great nobleman's park was considered complete without one. Chambers designed many of these buildings, as, for instance, for Lady Pembroke at Wilton, for Lord Bruce at Tanfield Hall in Yorkshire, casinos for Mr. Willoughby, Lord Tilney, and others and more especially a most sumptuous casino at Marino near Dublin for Lord Charlemont, said to have cost £60,000.

While engaged at Marino Chambers was also superintending various alterations at Trinity College, Dublin, including the new theatre and chapel. His next important works were Dudingstone near Edinburgh, begun in 1767, the observatory in Richmond Park in 1768, Castle Hill, Dorset, the entrance gateway and other additions at Blenheim, houses for Lord Melbourne in Piccadilly, 1770 (now the centre block of the

Albany), and for Lord Gower in Whitehall, and other works of more or less importance, which occupied his attention until he was employed on the great work of his life, Somerset House. Part of the old Royal Palace was pulled down in 1775 and the new buildings started in 1776. They were practically finished at the date of Chambers's death, though his complete scheme was never carried out in its entirety. Chambers's task was one of great difficulty. He had only a narrow frontage to the Strand in advance of his main area, though on the south side he had a magnificent frontage to the river. Moreover, Chambers had to provide sets of offices for various government departments and other purposes on a scale hitherto never attempted in England. These problems he solved with consummate success. The plan consists of an advanced block on the north side, with a frontage of 135 ft., containing the main entrance from the Strand; this block forms on the south side (that is, the side to the court) a recessed centre piece to the north end of the court. The court measures 240 ft. wide by 296 ft. deep, surrounded by buildings 54 ft. deep containing various government offices. The south, or river front, was intended to have a total length of 800 ft. Chambers's idea was to increase the width of his façade by building on the east and west sides of his main quadrangle detached rows of private houses running north and south, uniform in style with Somerset House, and connected with it on the south side by great archways opening on the terrace. Only the western part of this scheme was completed. Though the eastern arch was built, the buildings beyond it were left unfinished; and the river façade terminates at the south-east angle in a lame and discreditable corner.

I have pointed out above that the site, as handed over to Chambers, ran right down to the river. Chambers met this difficulty by building along the south side a platform of masonry above the level of the river, and on this he built a basement storey for warehouses and offices, fronted by a massive arcade of rustic masonry, supporting the great south terrace, 46 ft. wide. In the centre was a wide archway or water-gate, communicating with the basement storey; and at either end, opposite the open colonnades to the east and west of the quadrangle two gateways flanked by rusticated columns supporting lions. The appearance of the river front has been very much altered since the formation of the Thames Embankment. Before this was made,

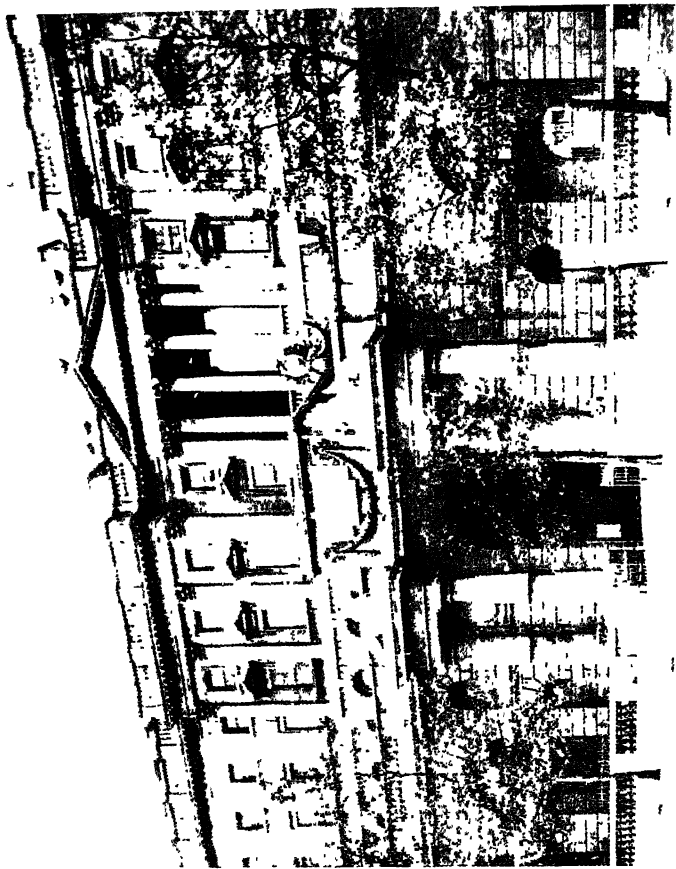

From Belcher and Macartney's "Later Renaissance, Etc."

SOMERSET HOUSE.

and before Waterloo Bridge was built, the building rose sheer out of the river at high water, and the tide ran in through the central archway under the terrace; at high water, at any rate, the effect must have been extremely fine, even finer than it is now; and this fact ought to be recollected in appreciating the design of the arcade below the terrace. Somerset House is faced throughout with Portland stone, and in spite of one or two settlements is one of the best built buildings in London. Chambers took immense pains with his detail. He had models made for his Ionic, Composite, and Corinthian capitals from the choicest antiquities in Rome; he was most careful in his selection of workmen, and most precise in his instructions. All that pains and intelligence could do, Chambers did at Somerset House; he had the best materials, the most skilful workmen and sculptors, his own exact knowledge and academical fastidiousness of taste. Yet pains and intelligence will not turn out a masterpiece. With all its merits—and the river front is one of the few really great public buildings in London—Somerset House is open to a good deal of criticism in detail. The Strand front is altogether inferior to Inigo Jones's fragment in Whitehall. The banqueting-house is 120 ft. wide out to out by 78 ft. to the top of the balustrade. Its façade consists of a rusticated basement, supporting a complete Ionic order, in seven bays, with a Corinthian order over, and a balustrade. The pilasters are coupled at the angles, and the centre bays slightly advanced beyond the rest. The Strand front of Somerset House measures 132 ft. 11 in. in width by 62 ft. to the top of the balustrade, and 70 ft. to the top of the blocking course of the attic storey over the three centre bays. The façade consists of a rusticated arcade on the ground floor in nine bays, with a Corinthian order over (comprising two storeys of windows) and a balustrade and an attic over the three centre bays. Chambers seems to have exactly inverted Inigo Jones's design. Instead of the continuous basement of the banqueting-house, he has started his arcade from the ground level. Instead of following the usual progression of orders, he has jumped at once from a rusticated ground storey to the Corinthian order; and where Inigo Jones, by making the three centre bays different from the two bays on either side, established a rhythm and proportion throughout the whole, Chambers has divided his nine bays into

three equal parts, with the result that his façade is flat and uninteresting, and misses the beautiful proportions of Inigo Jones's design.

Chambers's work is always a little forced and over-conscious; the consequence is that it is unequal, and sometimes fails in organic coherence. For instance, the main entrance from the Strand passes under vaulting, carried by two rows of coupled Doric columns. In itself this is an accomplished piece of classical detail, but it has no relation to the rusticated ground storey of the Strand front, and Chambers has not even attempted to get over the difficulty of combining the two. It seems evident that he thought out his designs piecemeal, that he worked not from the whole down to the details, but upwards, from the details to the whole—one of the worst faults of modern architecture. Chambers was a clear-headed and capable architect, with complete knowledge of his art; his masculine intelligence kept him clear of the frippery of the Adams, and he believed himself in earnest in following the great traditions of classical design. But somehow there is little vitality in his work. The vigour and energy of design possessed by the earlier men, their power of convincing the mind that their architecture was human and individual, and the expression of the designer's own personality—these and other qualities had gone out with the seventeenth century, and in studying the work of the last half of the eighteenth century one is habitually reminded of the unwelcome truth that first-rate intellectual capacity is not the same thing as genius.

Chambers had various pupils, of whom the ablest was James Gandon, architect of the Custom House at Dublin, the Four Courts, and other important works. Gandon was born in 1742. His first work was the County Hall and Prison, Nottingham, won in competition, and built 1769-70. He won the gold medal for architecture at the Academy in 1768, the second prize for a competition for the Royal Exchange in Dublin in 1769, and the first prize for the new Bethlehem Asylum in 1776, but in both cases his private interest was not sufficient to secure him the work. He had, however, powerful friends, and through Lord Carlow he was employed to design the new Custom House and Docks at Dublin in 1781. The difficulties of site somewhat resembled those with which Chambers had to deal at Somerset House: a good part of the site was under water at

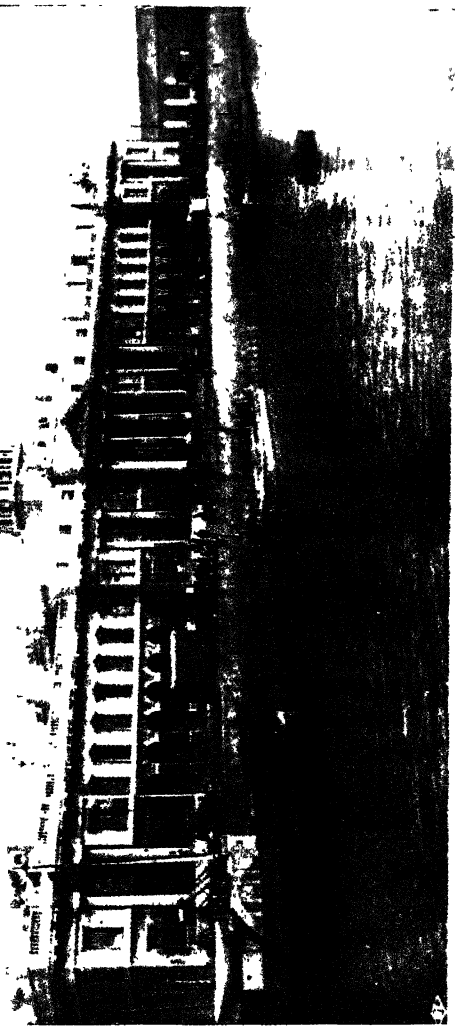

Firth & Co. photo.

THE CUSTOM HOUSE, DUBLIN.

high tide, water was found two feet below the surface, and when Gandon began pile-driving for his footings, water showed round the trial pile, and he had to substitute planking. Besides these natural obstacles, he had to contend with a very obstinate corporation, who began by pulling down one of his walls. Gandon, however, was finally successful, and the buildings were completed in 1791. The design is as able in its way as his master's design for Somerset House.

His other principal works were the Four Courts at Dublin, completed at a cost of about £60,000, the portico of Parliament House, with additions to the House of Lords, and the King's Rooms, Dublin, 1806-8. Gandon retired from practice in 1808, and died in 1823. As an architect he followed Chambers in his preference for Roman architecture, and in his general conception of design. His interest in architecture lay rather in its mechanical than in its artistic side, but he was a bold constructor and a man of powerful imagination. The Custom House of Dublin, with the splendid outline of its dome, ranks high in the record of the eighteenth century. With Newgate Prison and Somerset House it represents the final effort of the eighteenth-century tradition, and the three are probably the finest public buildings erected in Great Britain since the time of Wren.

Both in virtue of his parentage, and of his own manner in architecture, perhaps Dance the younger may fairly be taken as the last of the old school. He was the son of the old City Surveyor, and born in 1741. He had the advantage of his father in receiving an adequate training, for he went early in his life to Italy, and spent several years in that country in the study of architecture. In 1763 he won the gold medal of the Academy of Parma for a design for a public gallery, and in 1764 he was elected a member of the Academy of St. Luke's, at Rome. He appears to have returned to London either this year or in 1765, the date of his design for the Church of All Hallows, London Wall. He succeeded his father in the post of City Surveyor in 1768, and in the same year was elected one of the original forty academicians, and professor of architecture to the Academy. Dance died in 1825. Of his house designs, the most important examples are Wilderness Park and the Grange at Alresford in Kent, Stratton Park and Coleorton in Leicestershire, and various additions to Bowood. Dance also designed Finsbury

Square (1777-91), and Alfred Place and Crescent, Bloomsbury (1790-1814), a not very successful attempt in street design; the College of Surgeons, in Lincoln's Inn Fields,¹ and various other works; but his two most important works, one of which at least has assured him a permanent reputation, are St. Luke's Hospital in Old Street and Newgate Prison. Fergusson, who wrote with a superficial knowledge of English architecture, has blundered badly in regard to Newgate. After pointing out that Dance, the City architect, produced in the Mansion House "an effective and gorgeous design," especially before it lost what he calls "the two crowning masses" of the attic storey,² he goes on to say that his *chef d'œuvre* was Newgate Prison, and that "from what we know of Dance's character, we are led to suspect that it may have been mere ignorance that led him to do right on this occasion." Fergusson evidently knew nothing at all of Dance's character, for Newgate was designed by his son (George Dance the younger, an architect who had received an exceptionally thorough training in his art), and was not begun until 1770, two years after the death of the elder Dance, and was not finally completed till 1782. In Newgate Prison Dance succeeded in producing an extraordinarily impressive building. The main façade consists of an immense rusticated wall of stone, 297 ft. long, and about 50 ft. high, with a broad projecting bay in the centre, carried one storey above the blocking course, and two smaller bays on either side, with niches above the ground storey. These bays or projections are very slightly advanced in front of the line of the façade. The prison entrances are to the right and left of the central bay. The fault of the design is the unpleasant crowding of the windows in the centre bay, necessitated, no doubt, by the fact that this was the keeper's house, but closer thought might perhaps have hit on some treatment more in scale with the rest, and might have avoided the unpleasant conflict between the arched window-heads and the massive squareness of the rest of the building. This is the one fault of the design. The two entrances on either side are admirable in their austerity and perfect maintenance of scale. It is seldom, indeed, that an architect gets a chance of a huge bare

¹ Since rebuilt by Barry.

² The south attic was removed by young Dance in 1795-96, and the north was taken down in 1842. See above, chapter x., p. 192.

wall to deal with, but no architect ever made a better use of his opportunity than did Dance at Newgate. How far it may have been suggested by Piranesi's *Carcere d'Invenzione*, it is difficult to say, but that Dance knew thoroughly what he was about there can be no question. In the hospital of St. Luke's, Old Street, he gave further evidence of his power to grasp the imaginative conditions of an architectural problem. This building, though in a less degree than Newgate, shows Dance's capacity for severe selection and restraint in his design, and one the more regrets that in his later works Dance lost touch of this excellent simple manner, and in the Church of St. Bartholomew the Less wandered off into the ridiculous Gothic of the period.

For some time, however, the tendency to eclecticism, with its accompanying anarchy of taste, had been steadily at work; and perhaps the chief offenders were "the four enterprising brothers named Adam," as Britton and Pugin somewhat contemptuously style them. The Adams were a family of architects. William Adam, the father, was an architect of considerable reputation in Scotland between the years 1730 and 1760, and all his four sons were brought up to the same calling. Robert and James, however, were the most famous, and they were throughout associated in their work, the only independent designs attributed to James Adam being the Adelphi buildings and certain houses in Portland Place; but these so exactly resemble the work of his more celebrated brother, that it is impossible to assign to them any distinct manner in design, and for the purpose of the history of architecture, Robert Adam may be taken as representing the brothers.

Robert Adam was born in 1728, and educated at Edinburgh University. He began his travels in 1754, when he visited Nismes; he was at Rome in 1756, and at Venice in the summer of 1757, when with Clerisseau and two other draughtsmen he spent five weeks in measuring up the ruins of Diocletian's palace at Spalatro. The drawings of this palace were published in 1764. Adam returned to England in 1758, and at once began practice. The screen and gateway of the Admiralty, one of the earliest of his designs, and on the whole the best, was built in 1760; and Shardeloe in Buckinghamshire, 1759-61, was his first important house, followed up by an extensive remodelling of Sion House in 1761-62, and Kedleston, 1761-65,

a design often spoken of as characteristic of Adam's manner, though in point of fact the credit of the plan belongs to Paine. Shelburne House (now Lansdowne House) was begun in 1765, Kenwood, between Highgate and Hampstead, in 1764-67, Luton House in 1767, and the Ranger's Lodge in the Green Park (since destroyed) in 1768. From 1768 onwards the brothers were busily employed in London. The Adelphi buildings, including the house of the Society of Arts, which were carried out from their designs, appear to have been a family speculation, and it seems that the Adams enjoy the doubtful honour of being the earliest of modern English architects to enter on the thorny paths of finance and speculative building. Mansfield Street, Portland Place (1770), a house at the corner of Harewood Place, Stratford Place, and a great quantity of houses between Park Lane and Hanover Square, seem to have been built in this way by the Adam family, and decorated with their—or rather with Liardet's—patent stucco, a material in which the Adams had a pecuniary interest. Meanwhile, Robert Adam carried on his private practice indefatigably. In 1771 he designed the Record Office at Edinburgh; in 1773 he designed a house for Sir Watkyn Wynne in St. James's Square, and one for Lord Derby in Grosvenor Square; in 1776 Drury Lane Theatre, and the infirmary at Glasgow at about the same time. The new buildings for Edinburgh University were begun from his designs in 1778, but only part of Adam's designs was carried out. In 1776 he designed an extraordinary church at Mistley in Essex, White's Club House, and various private houses, including Osterley Park, Witham in Somersetshire, and Compton in Warwickshire, and additions, alterations, and decorations for houses without number. Gosford House in East Lothian was one of the brothers' latest works, and the east and south sides of Fitzroy Square (1790) their latest venture in speculative building. Robert Adam died in 1792 and was buried in Westminster Abbey, and his brother James died two years later.

It is evident from certain remarks in his published works, that Robert Adam regarded himself as an original thinker in architecture on two grounds: first, that he had introduced a fresh method of house planning; and, secondly, that he had greatly purified ornamental detail and enlarged its scope. In his preface he takes credit to himself for having "brought about

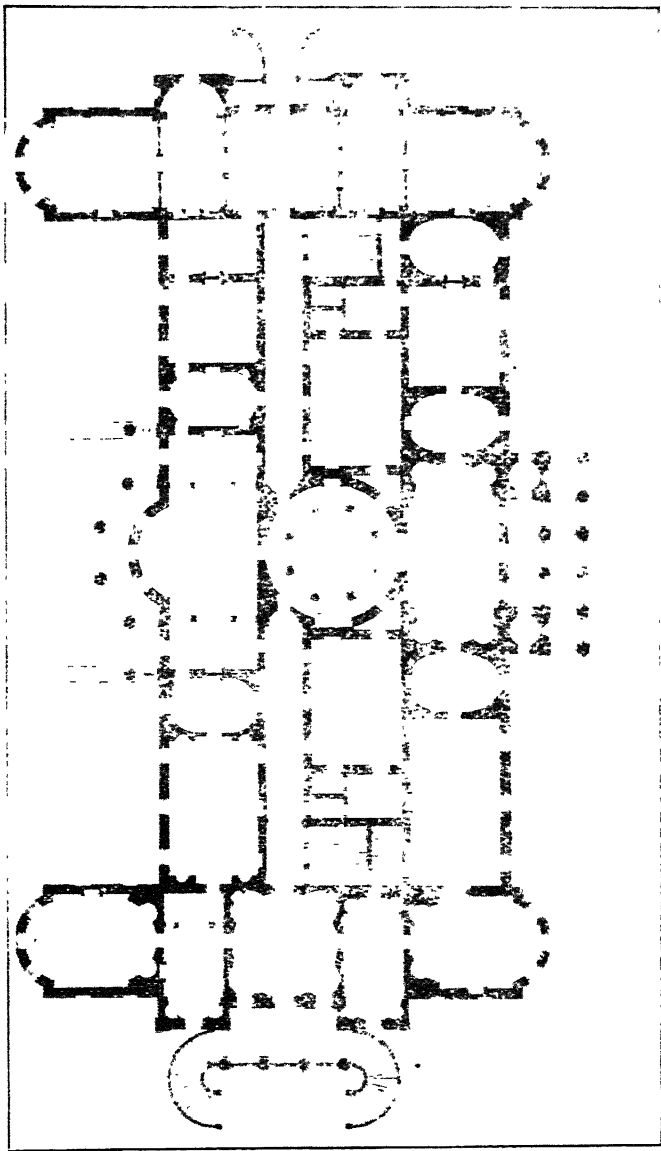

PLAN OF LUTON HOUSE.
(R. and J. Adam's, "Works in Architecture," i. 2.)

a kind of revolution in this useful and elegant art," for Adam had no false modesty about his work. In regard to house planning, he considered that he had advanced on Inigo Jones and others "in the disposition and relief of his apartments," by which he seems to mean that whereas they were content with comparatively simple forms such as squares, oblongs, or circles, he introduced an abundance of ovals and ellipses, and constantly varied the shape of his rooms in order to avoid monotony. As a matter of fact, if he had turned over the pages of the "Vitruvius Britannicus," he would have found that he had been anticipated in every one of his inventions, but Adam certainly had a remarkable power of designing great vistas of rooms *en suite*, and though he spoilt them by the feebleness of his decorations, some of his plans are very able. Sion House is a good example. The original plan which Adam was called in to remodel was quadrangular. Adam filled this up with a great central hall, 50 ft. in diameter, surrounded by a peristyle, giving a total diameter of 70 ft., and he brought this court into communication with the sides by vestibules in the centre of the four sides. He repeated this plan in a new building in the Record Office at Edinburgh, where the diameter of the central hall is also 50 ft. So again at Luton House, built for Lord Bute in 1767, and one of the best examples of Adam's domestic work, he adopted a general H-shaped plan, the centre occupied by a circular hall 40 ft. in diameter opening into a saloon 64 ft. by 24 ft., the left-hand wing occupied by the dining-room, ante-room, and with drawing-room *en suite*, the right-hand wing by the library, cut up into three divisions by colonnades, but capable of being thrown open, so that a vista could be obtained from end to end of a total length of 142 ft. At Lansdowne House, in much the same way, he formed the gallery of three rooms *en suite*, an oblong room in the centre, 38 ft. by 30 ft., with circular rooms at each end, 30 ft. in diameter, giving a total length of 103 ft. In Lord Derby's house, and Sir Watkyn Wynne's, both built on long narrow sites and very well planned, Adam again devoted himself to providing sets of rooms *en suite*, but the houses, whether for effect or convenience, are in no way superior to many an example of a London house, planned fifty or a hundred years before. In regard to detail, Adam's pretensions have even less foundation. He understood selection in ornament; that is to say, he knew where to place his ornament,

and at his best, where to stay his hand; but in so far as he introduced any innovation in detail, it was wholly for the bad, and probably little value would be placed on the furniture and other articles carried out from his designs, except for their admirable workmanship, for skill in execution long outlasted the capacity for design in English architecture and its handicrafts. Adam considered that he had refined the details of Roman architecture by reference to Greek models, but as he depended for his accuracy on Stuart and Revett, the result was neither one thing nor the other, and inferior to either. He notes certain modifications which he introduced into the volute, and that he diminished his columns from the base upwards, instead of from one-third of the way up, and he also invented what he calls a Britannic order with lions and unicorns for volutes. But what he particularly prided himself on was his stucco ornamentation, on pink, green, and light-blue ground; and his "Etruscan manner" coloured red, yellow, brown or black, on a white ground, which was really based on second-rate Roman wall decoration. Such work was merely fashionable, and speedily gave way to fresh fashions and revivalisms, in their turn to disappear before the modern Gothic revival. Adam was the immediate precursor of Wilkin and Soane, and can hardly be looked upon as belonging to the traditional line of English architects. His earlier work, such as the Admiralty screen, touches it; but his later designs, such as Fitzroy Square, are as remote from the manner of Inigo Jones or Christopher Wren, as the work of the eminent Nash himself. The Adams in fact introduced little into English architecture of any value, but they did introduce a quantity of meaningless ornament, and they set the fashion for cheap reproductions of the antique, and introduced a certain insincerity of taste from which the art has by no means recovered. Robert Adam exhibited in an exaggerated form a quality to some extent peculiar to the eighteenth-century architects, the quality of intense self-consciousness. In varying degrees these men were all impressed with a sense of the immense magnificence of their own work. Colin Campbell sounded the first note of it early in the century. Fifty years later, James Paine, cool-headed as he was, wrote: "The rapid progress of architecture in Great Britain within these last thirty years is perhaps without example in any age or country since the Romans." Then came Adam with his "revolution in this

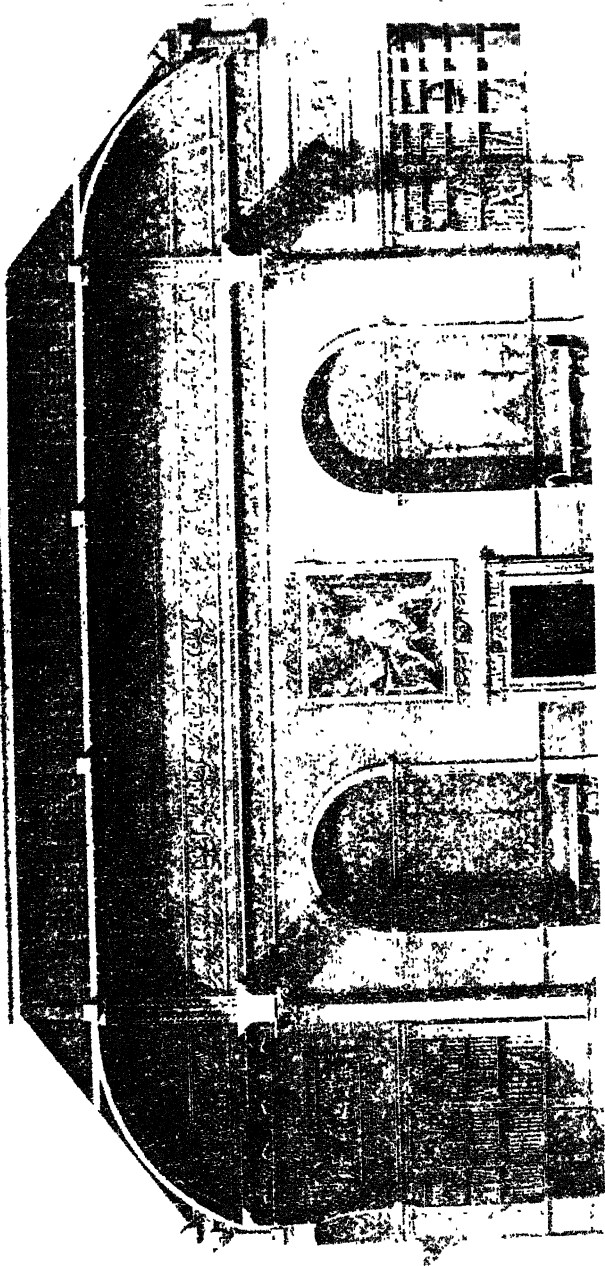

SECTION OF THE LIBRARY AT KENWOOD HOUSE.
(R. and J. Adam's "Works in Architecture," i. 5.)

elegant art"; and finally, in 1827, when Britton and Pugin published their "Public Buildings of London," Britton wrote in his preface: "The architectural improvements of the present age exceed in extent, variety, number, and taste, those of any former period." We are thus able to arrive at some idea of the slow decay of architecture in England. These self-congratulations, ever increasing in certainty, are so many marks to show the gradual withdrawing of the tide till it reached the complete low-water mark of the first half of the nineteenth century.

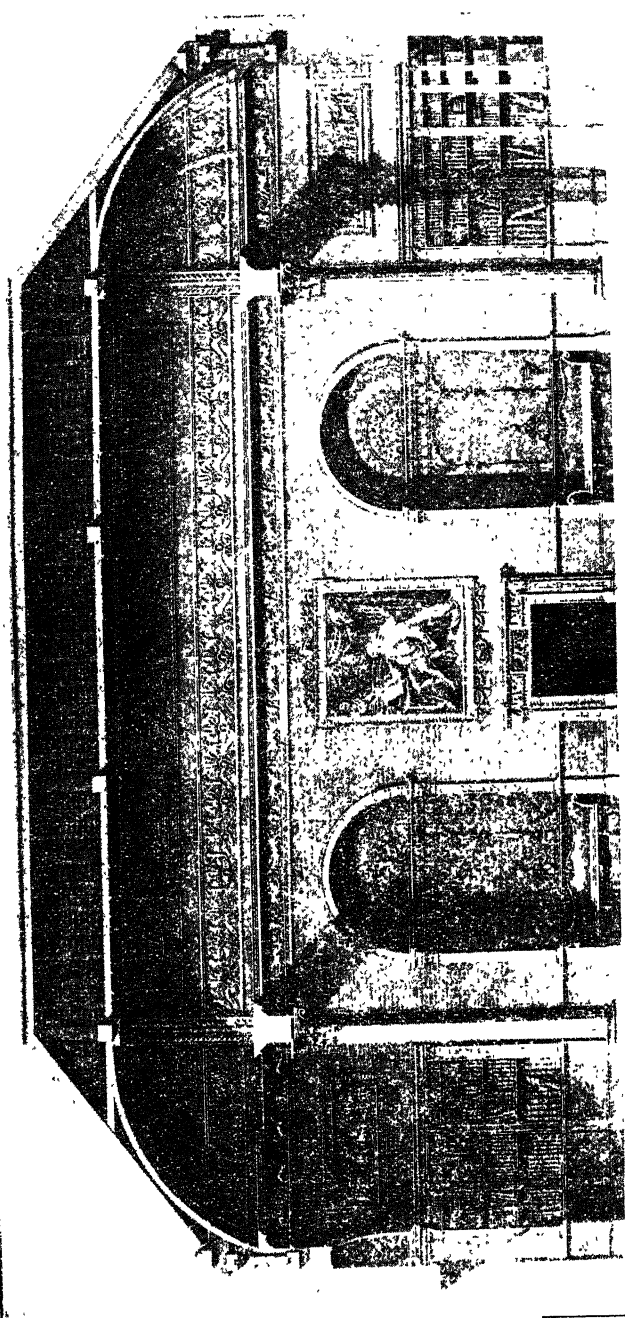

SECTION OF THE LIBRARY AT KENWOOD HOUSE.
(R. and J. Adam's "Works in Architecture," i. 5.)

elegant art"; and finally, in 1827, when Britton and Pugin published their "Public Buildings of London," Britton wrote in his preface: "The architectural improvements of the present age exceed in extent, variety, number, and taste, those of any former period." We are thus able to arrive at some idea of the slow decay of architecture in England. These self-congratulations, ever increasing in certainty, are so many marks to show the gradual withdrawing of the tide till it reached the complete low-water mark of the first half of the nineteenth century.

CHAPTER XII

HOUSE PLANNING IN THE SEVENTEENTH AND EIGHTEENTH CENTURIES

IN a previous chapter¹ I endeavoured to show how the civilized house of the latter part of the sixteenth century grew out of the two types of the mediæval house ; first, from the fortified house with inner courts, and in the second place from the smaller mediæval house with a hall in the centre and rooms at either end ; and how, by slow degrees, the hall, from being the common living room of the household, developed into a main entrance hall for access to the great staircase and for communication between the different rooms. As the necessary accompaniment of this change, the old solar developed into the withdrawing room ; a separate dining chamber was provided, and the great gallery, characteristic of the seventeenth century, became the principal feature of the house. The Jacobean house, though by no means perfect in plan, was fairly reasonable in its arrangements. Its chief defect was that the building was very thin, that is, it seldom comprised more than a single set of rooms and a corridor which had to be ranged round the sides of a court, and the consequence was that the long draughty passages made the house cold, and that the kitchen and offices were placed at an inconvenient distance from the living rooms of the house.

With the introduction of Palladianism, early in the seventeenth century, all this was changed. Inigo Jones came back from Italy with his mind saturated with the designs of Palladio, and he set to work to introduce his ideas with an energy and genius that practically revolutionized house planning in England. The quadrangular plan was generally abandoned. The ground

¹ Chapter IV.

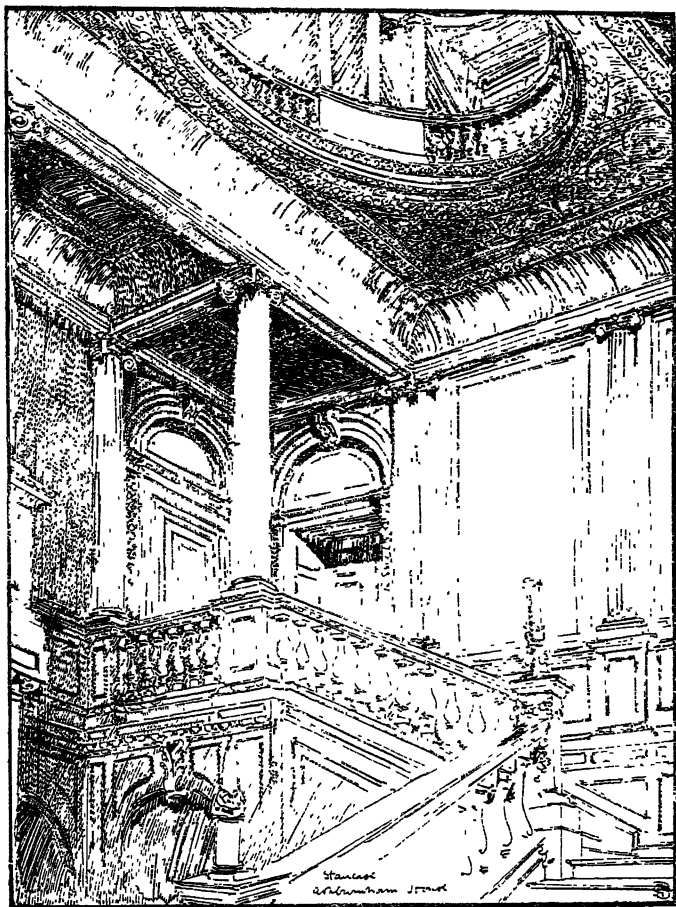

STAIRCASE, ASHBURNHAM HOUSE.

floor was treated specifically as a basement: Inigo Jones expressly notes in his Palladio that "cellars and other magazines should never be put under ground." The first floor became the piano nobile which controlled the whole plan, and usually

necessitated the sacrifice of other parts of the house. The only survival of the Jacobean plan was the great gallery which, in a modified form, lasted well into the eighteenth century. This first or principal floor was usually reached by a grand flight of steps outside the house, which gave access to the main entrance hall and thence to the principal rooms ranged on either side of the hall and beyond it. Rainham in Norfolk is an instance. The immediate result of this change was the practical abandonment of the great staircase. As soon as the principal rooms of the house were collected on the first floor, and access to this first floor was provided from without, the *raison d'être* of the grand staircase as the approach to the chief reception rooms was gone. Accordingly the staircase was usually confined to the subordinate function of communicating with bedrooms and attics only, and there was consequently little inducement to spend money on its decoration. This was less the case in the seventeenth century than in the eighteenth. The tradition of the sixteenth century was too deeply engrained in the architecture of the country to be abandoned at once, and throughout the seventeenth century beautiful staircases, such as that of Ashburnham House and Coleshill, continued to be built, in which, though Palladian details were used, some of the feeling of the fine spectacular staircase of the Elizabethan house still lingers. Inigo Jones had too fine an artistic instinct to abandon readily such a valuable means of effect. But there was usually some specific reason as well, such, for instance, as a contracted site, to account for these grand staircases in later work. The eighteenth-century architects lost all touch with this tradition, and one finds in their plans a growing tendency to sacrifice everything to the hall, the salon, and the reception rooms, and to treat the staircase, or rather staircases—for the exigencies of their design compelled them to introduce several—as merely necessities of communication; the chief exception to this being in the case of town houses, where the limitations of the site prevented a grand external flight of steps, and the entrance had to be made in the ground floor with access to the reception rooms on the first floor by a principal staircase.

Partly on account of the wider range of his genius, and partly owing to the conditions of contemporary architecture, there are more variations to be found in the plans of Inigo Jones than in those of his successors. In the plan of Lindsey

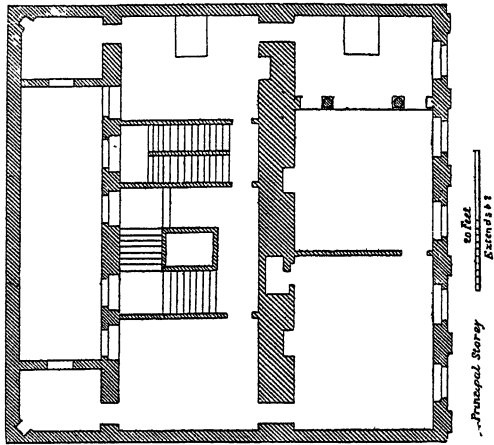
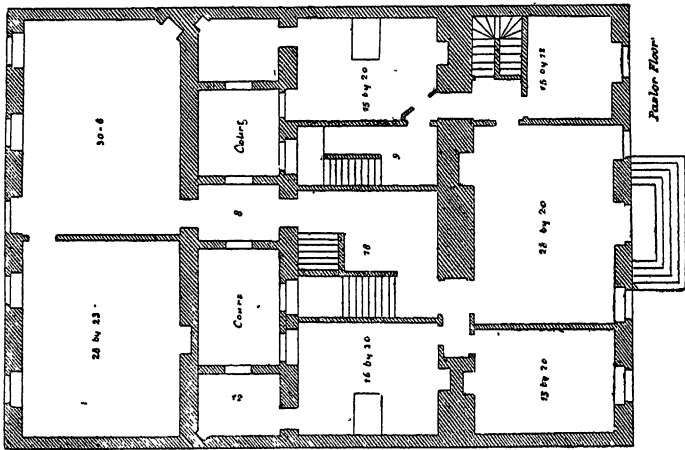

PLAN OF LINDSEY HOUSE.
 ("Vitruv. Brit." i. 49.)

House (1640) there is a grand staircase at the back of the entrance hall, with a servants' staircase at the side from the basement to the first and principal floor, and the hall is the height of one floor only. On the other hand, at the Queen's House at Greenwich, designed about the same time, Inigo Jones provided a salon, a cube of 40 ft., occupying the height of both storeys, with a large circular staircase entered from one corner of the salon, and two other staircases. In both houses Jones provided small courts to light the inner rooms, a somewhat objectionable device, but one more reasonable in every way than the method of the eighteenth-century architects, who were content to light their mezzanines and passages with borrowed lights from the hall or the leads, or who dispensed with light and air altogether if the windows interfered with the symmetry of their design. Here again the virtue of the older English tradition of planning is evident, for these small courts are the survival of the English sixteenth-century plan, which made light and air points of primary importance, as the result of long experience of the necessities of an uncertain climate. The eighteenth-century architects were in constant difficulties about light and air for the bedrooms and servants' quarters, because they insisted on following literally the designs made by an Italian architect for an Italian climate.

Chevening in Kent, designed by Inigo Jones, is typical of an arrangement which became common towards the end of the seventeenth century; the plan is an oblong of about 88 ft. by 65 ft.; of this the hall and salon together occupy rather more than a third of the total plan, the hall and salon measuring 31 ft. in width, the suites of apartments on either side each measuring 21 ft. in width. Coleshill in Berkshire is another example. The plan here is an oblong, with hall and salon in the centre, as at Chevening. The staircase is in the main entrance hall, 40 ft. by 31 ft., at the back of this is the salon, 41 ft. by 22 ft., and the two take up almost exactly the centre third of the total ground area. The great dining-room was on the first floor, immediately above the salon, and accordingly the architect reverted to the older habit of making a grand staircase in order to bring the dining-room into connection with the reception rooms of the house. Two separate flights start on either side of the main entrance, reaching a landing in front of the dining-room on the upper floor. The basement

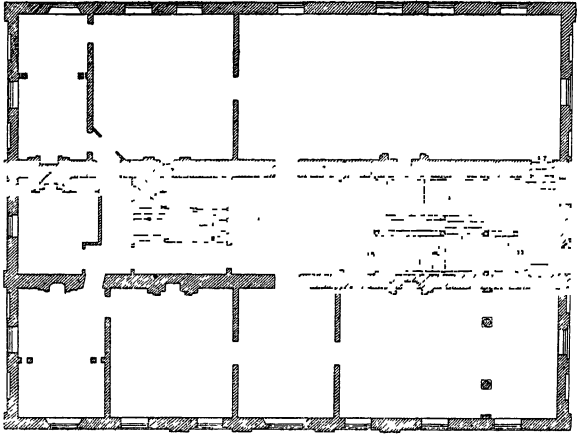

FIRST FLOOR PLAN

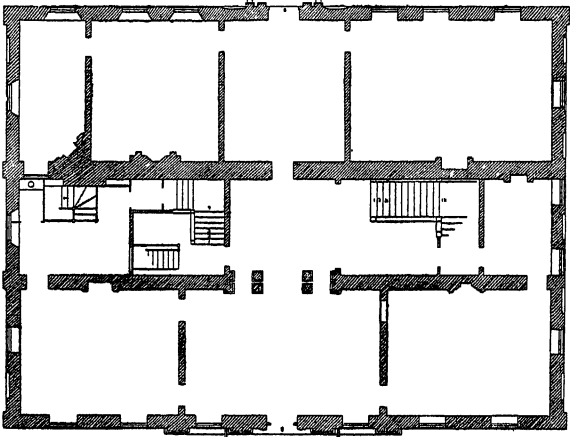
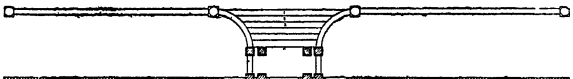

GROUND

PLAN

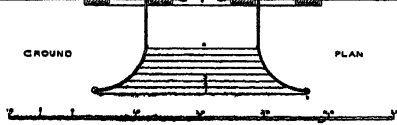

PLAN OF ELTHAM CLUB-HOUSE.

storey, with windows above the ground level, is entirely occupied by the kitchen and offices, storerooms and cellars. The comparative simplicity of this plan makes it one of the best examples of seventeenth-century planning.

At Amesbury in Wiltshire (since rebuilt) the main staircase was at the back of the hall, and the two together occupy about a third of the total plan. In the Amesbury staircase the well was occupied by a circular newel staircase inside the main stairs, an idea borrowed from the well-known double staircase of Chambord. In the fine house at Eltham (now occupied by the Golf Club), which probably dates from about 1660, fully one-third of the house longitudinally is taken up by the principal staircase and a serving stair beyond.

To sum up briefly the evidence given above, it appears that Inigo Jones's favourite plan was either a square, as at Greenwich or Gunnersbury, or an oblong, as at Coleshill and Chevening. Roughly speaking, he divided this into three parts, devoting the central third, or thereabouts, to the hall and staircase. This was a great advance on the courtyard plan of the Jacobean designers in compactness and convenience, and, with the exception of modern revivalist work, has been more or less adhered to ever since. As part of his system of proportion, Inigo Jones greatly increased the height of his rooms, introducing the double cube, as in the great room at Wilton, or the single cube, as at Greenwich; but, generally speaking, he was content with 16 ft. to 18 ft. for the principal floor, and from 14 ft. to 16 ft. for the bedrooms. The exaggerated heights of later work were due to the eighteenth-century architects. In the "Designs of Inigo Jones," published by Kent, a number of eccentric designs are given which are of doubtful authenticity; such, for instance, as the plans based on a Greek cross, and the various circular and octagonal plans. No name is given to these designs, and it is very doubtful whether, if made by Inigo Jones, they were ever intended by him as anything more than exercises in the Palladian manner, being in many cases based on designs given in Palladio's work. It is probable that Kent found them in Lord Burlington's collection of drawings, and allowed himself considerable licence in their reproduction. In any case, they have no more relation to the development of English house planning than such caprices as Campbell's villa at Mereworth.

Not only did Inigo Jones thus introduce the block plan as opposed to the courtyard plan, but it seems probable that he was the first architect in England to adopt the plan of a central block with advanced wings, which became such a prominent feature in the larger designs of Vanbrugh and his successors. The earliest instance of this that I can find is Stoke Park in Northamptonshire, which, according to Campbell, was begun by Inigo Jones in 1640, and carried out as far as the wings, colonnades, and the foundations of the house, when the work was stopped by the Civil War, and the house was completed after the Restoration. The main block stands in the centre, and from the two front angles start colonnades, laid out as a quadrant, communicating with the library to the left, and the chapel to the right. A raised terrace or platform occupies the space between the front of the house, the chapel, and the library, with a flight of steps to the terrace opposite the centre of the house; the total length of the façade is shown as about 260 ft. The next step was to extend this plan by omitting the terrace and making the colonnades and the advanced wings part of the forecourt, and bringing the flight of steps right up to the main entrance. This was done by Wynne, at Buckingham House (since destroyed), built in 1705. The total façade was about 280 ft., but the position of the wings was advanced considerably further up the forecourt than at Stoke Park. At old Cliefden House, for which Wynne made the original designs, not only were there the two detached blocks forming pavilions in advance of the central block, with the quarter-circle colonnades as usual, but to the right and left of these wings were two more sets of detached buildings, occupied by the stables and offices, with a total frontage of 433 ft.

This form of plan is to be distinguished from the ordinary forecourt plan, such as old Montague House, where the two sides of the forecourt were formed by continuous ranges of building, the distinction between them being that whereas the latter is to all intents a three-sided court, the former consists of three distinct parts, namely, the main block or house proper, and the two detached wings treated as pavilions, with the connecting links given by the quadrant or other colonnade. This plan, as I shall show, was varied in many ways, but the essential feature of it is the separation of the house from the wings, and the subordination of the latter to the main central block in the

general composition. It was to this that Sir Joshua Reynolds referred in his encomium on Vanbrugh. "To support his principal object, he produced his second or third groups or masses, he perfectly understood in his art what is the most difficult in ours, the conduct of the background . . . and no architect took greater care than he that his work should not appear crude and hard, that is, it did not abruptly start out of the ground without expectation or preparation." Vanbrugh, as I have pointed out, was not the inventor of this method of design, but he used it freely and with considerable success. At Blenheim and Castle Howard it is used on a colossal scale, and Vanbrugh undoubtedly succeeded in producing impressive piles of building in his particular manner. It was, however, a very costly method of plan, and extremely inconvenient for all practical purposes. Plans are given in the "Vitruvius Britannicus," in which the only access from the kitchen to dining-room is through a colonnade open on one side to the court, and then through various suites of rooms. At Blenheim, as originally designed, servants going from the kitchen to the hall and dining-room would have to pass first through the open air, and then through interminable corridors. It is, of course, necessary to isolate the kitchen and servants' quarters from the big rooms of a house, but such a total disregard of convenience and economy of service as is shown in these eighteenth-century plans would not be tolerated for an instant in modern house planning. The point of view has shifted. Vanbrugh and his successors were permitted to subordinate the comfort of the house to its external architecture. They began from without and worked inwards; the entire design was handled with a view to the realization of a certain composition, without regard to convenience of arrangement; and the consequence is that there is always a distinct architectonic conception running through the whole of any one of their designs, which is necessarily absent in the heterogeneous assemblage of buildings which compose most modern country houses.

Notwithstanding the inconvenience of this detached wing plan, it continued in use till the latter part of the eighteenth century, one of the latest important examples being Fonthill in Wiltshire, built by William Beckford before 1771, at a cost of about a quarter of a million, probably from designs by Paine, who was employed at Wardour Castle in the neighbourhood.

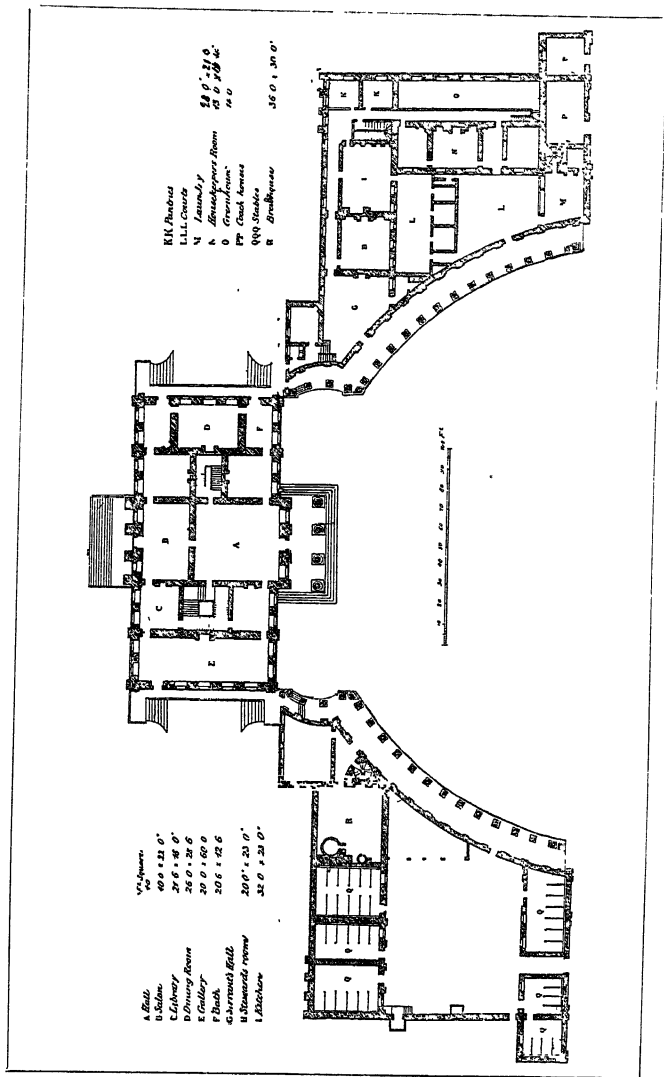

PLAN OF MOOR PARK, HERTFORDSHIRE.

Leoni adopted this plan early in the century at Latham Hall in Lancashire, a fine, simple design, with a frontage of 320 ft., and again at Moor Park in Hertfordshire, and the ingenuity of the eighteenth-century architects was a good deal exercised on this particular form of plan. Sir William Bruce, a skilful Scotch architect, made the colonnades of Hopetown House in Scotland (1698-1702) convex to the court instead of concave as usual. At Duncombe Park in Yorkshire, carried out in 1713 by Wakefield from Vanbrugh's design, the main block stands in advance of the detached wings, and this arrangement was repeated by Carr of York in his design for Oakland House (1762), in which the kitchen, offices, and servants' quarters occupied two wings at the back of the house. Kent (or Campbell) introduced another variation at Holkham, when he set four detached buildings or wings at the angles of the main block, and connected with it by single corridors, a somewhat original plan which was not immediately repeated, but which may have indirectly suggested to Paine and Adam the possibility of reproducing Palladio's design for Lionardo Mocenigo at Kedleston. In his anxiety to arrive at complete symmetry Adam was driven to some curious straits, for the greenhouse and the chapel together were to form the south-west wing, and in the south-east wing the organ and music-gallery were placed immediately above the stables. Adam did, however, place his kitchen within comparatively easy range of the dining-room. Paine adopted a somewhat similar plan in his design for Nostell in Yorkshire, though the internal arrangements are quite different. Eastwell in Kent, by Bonomi (1793-1800), was one of the latest survivals of this plan with advanced wings and quadrants.

The centre block with detached wings was not, however, the only plan in use for larger houses in the latter part of the seventeenth and the eighteenth centuries. Inigo Jones, as we have already pointed out, occasionally used internal courts, as at Greenwich. Wren rebuilt part of Hampton Court as a quadrangle, probably, however, out of regard for the older buildings. Talman made an inner court at Chatsworth, 75 ft. by 96 ft. At Grimsthorpe in Lincolnshire, Vanbrugh provided an internal court 105 ft. by 78 ft., and Flitcroft designed Woburn Abbey as a great quadrangular court measuring internally 149 ft. 1 in. by 139 ft. 3 in. Small internal courts continued to be used for light and air throughout the eighteenth century; but the growing

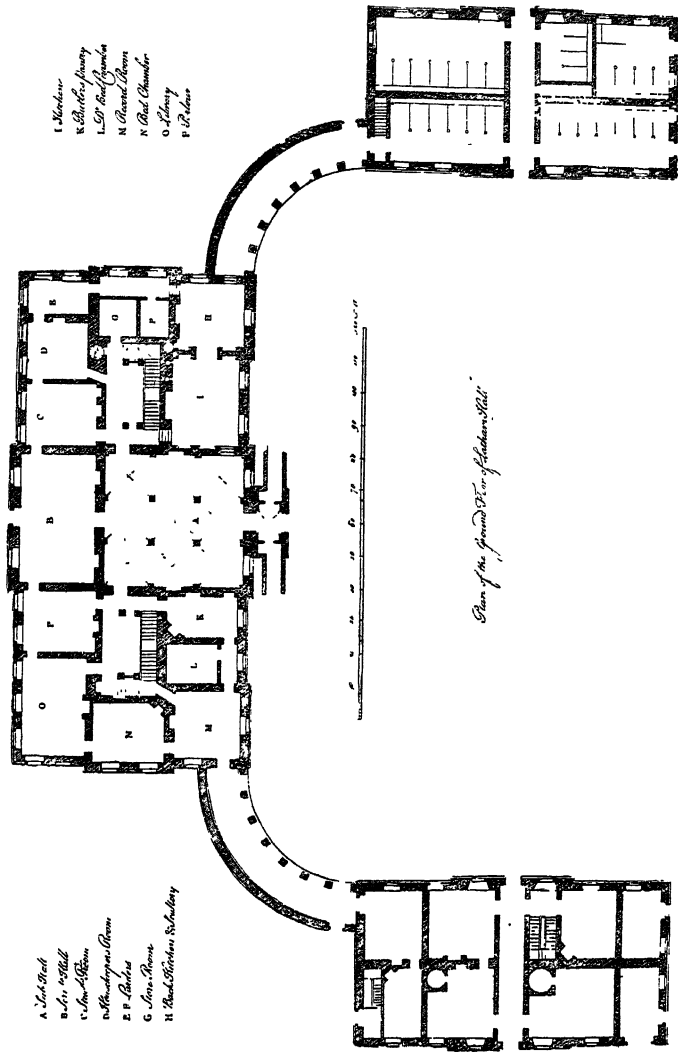

- A. Lath. Hall
- B. Lib. & Hall
- C. Lath. & Room
- D. Study & Room
- E. F. Parlor
- G. Serv. Room
- H. Wash. Kitchen & Laundry

- I. Kitchen
- K. Dining Room
- L. P. Bed Chamber
- N. Second Room
- K. Bed Chamber
- O. Library
- P. P. Room

Plan of the ground floor of Latham Hall.

PLAN OF LATHAM HALL.

fondness for top-lighting halls and staircases, and the comparative indifference as to whether light and air were borrowed or obtained direct from without, led to the gradual disuse of the inclosed courts. The three-sided court, so common in the reigns of Elizabeth and James I., hardly outlived the seventeenth century. Maiden Bradley in Wiltshire is probably one of the latest examples of its use in England, and the H-plan disappeared about the same time.¹ By the latter part of the eighteenth century the rectangular block, either square or oblong, with or without attached wings, was fairly established as the accepted plan.

In regard to internal arrangements, Wren and his immediate contemporaries did not materially alter the plan left by Inigo Jones. At Marlborough House Wren placed his hall in the centre, with staircases on either side, and rooms *en suite* beyond, and small newel staircases were provided as well. Most of Wren's plans in the All Souls' Collection show a great quantity of staircases to reach the separate parts of the house. No. 18 in vol. i. shows an oblong plan divided into three approximately equal parts, of which the centre third is occupied by the hall and staircases. The main staircase is at the back, and allowed a vista through the hall, from the front to the garden door, under the first landing of the stairs. The same idea is shown in drawing No. 24, a design for Lord Allarton, an excellent plan for a moderately sized house. Captain Wynne employed it at Newcastle House with a slight variation, and in each case the space provided for staircases is divided into three parts, of which two were assigned to the main stairs and the third to the back stairs. This plan was frequently employed for town houses towards the end of the seventeenth century. In the "Gentleman's Magazine" for 1814, Part II., John Carter mentions an important house of about this date, which used to stand on the north side of Covent Garden, and which has since been destroyed. His account of the plan resembles that given above: "Hall storey: Entrance front south, giving admission through a portico taken out of the centre division of the front, into the Hall. Left and right, chambers; in the hall grand stairs, behind the right chamber, back stairs. From centre of hall, a passage to the garden." The principal rooms were on the first floor,

¹ This plan is shown in "Vitruvius Britannicus," ii. 56.

elaborately decorated.

At old Buckingham House Wynne followed a different plan. The great staircase was immediately to the left of the entrance hall, and only separated from it by an arcade in three bays. The entrance hall measured 45 ft. by 35 ft., the staircase 43 ft. by 35 ft. Campbell describes the effect of this arrangement as "august and lofty," and an account of it, contained in a letter from the Duke of Buckingham the owner, to the Earl of Shrewsbury, is quoted by Carter in the "Gentleman's Magazine" for 1814, Part II. "To the right of the hall was the parlour, 33 ft. by 39 ft., with a niche for a buffet, and beyond this, at the back of the hall and staircase, was a suite of apart-

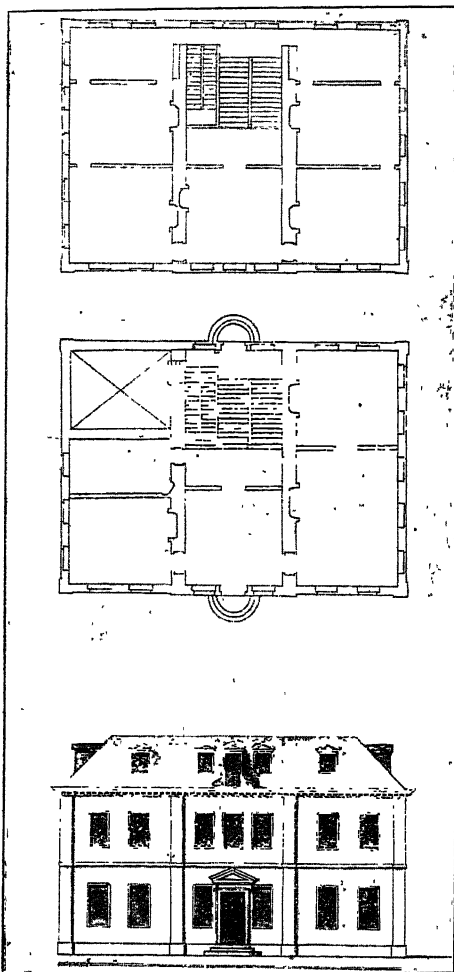

PLAN AND ELEVATION, VOL. I., NO. 18, WREN'S DRAWINGS.

(All Souls' Collection.)

ments. On the left hand of the hall are three stone arches, supported by Corinthian pillars, under one of which we go up eight-and-forty steps, 10 ft. broad, each step of one entire Portland stone: these stairs, by the help of two resting-places, are so very easy that there is no need of leaning on the iron baluster. The walls are painted with the story of Dido. . . . The roof of this staircase, which is 55 ft. from the ground, is of 40 ft. by 36 ft., filled with the figures of gods and goddesses. . . . The bas-reliefs and little squares above are all episodical paintings of the same story; and the largeness of the whole has admitted of a sure remedy against any decay of colours, from saltpetre in the wall, by making another of oak laths, four inches within it, and so primed over like a picture." Most of this was standing intact when Carter made his survey early in this century. At Finchcox, near Goudhurst, in Kent, a good brick house built before the middle of the eighteenth century, the entrance hall extends from the back to the front of the house, and the staircase is on the right-hand side, at the further end, but not separated from the hall.

The most important modifications made by the eighteenth-century architects in internal construction are the greatly extended use of top-lighting, and the increased and often unreasonable height given to the rooms. Both modifications on the traditional English methods were due to the same cause. The bent of these architects was academical, that is to say, encouraged and even compelled by their patrons, they were more intent on correctness of scholarship, on strictly orthodox reproductions of Palladian models, than on reasonable compliance with the conditions of light and climate inevitable in this country. In so far as fashionable architecture was concerned, there was a positive mania for the Italian manner, and the extreme inconvenience that resulted is evident on an examination of their published designs. Even so practical an architect as Gibbs thought nothing of putting windows under the deep shadows of pediments, or borrowing his light from the upper part of the hall, where the only light available was a very feeble reflected light. So again, Campbell, in a design dedicated to the Duke of Argyll, lit the mezzanines containing rooms for the family from the leads in order to preserve the façade from too many windows. At Hopetown House in Scotland (1698) the principal staircase is an octagon in the centre of the building, which is

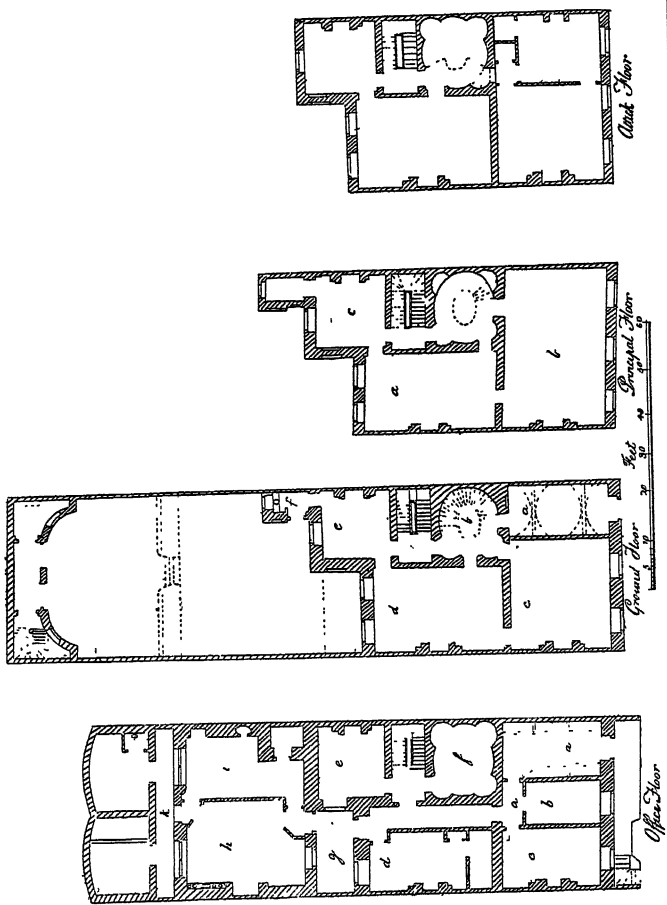

PLANS OF DR. HEBERDEN'S HOUSE IN PALL MALL.
 (J. Paine's "Plans, Elevations and Sections.")

approximately square. This octagon is lit by a large cupola carried up above the flat of the roof, and many variations of this central top-lighted staircase may be found in the plates of the "Vitruvius Britannicus." In certain sites such a staircase may be inevitable; but the disadvantages it presents, insufficient light, and extreme cheerlessness in the lower storeys ought to prevent its being used where there is plenty of room on the site. The fashionable architecture of the eighteenth century was as insincere as its fashionable literature, and it is only in the last forty years that domestic architecture has begun to free itself from some of the worst traditions of eighteenth-century planning. Carr of York and Adam were immoderately fond of the top-lit hall, as for instance Adam's work at Kedleston. In his plans for Thoresby, dated 1770, Carr placed an elliptical hall in the centre of the building, running up two storeys and with direct light only admitted from a light in the top of the cupola; and it appears to have been Carr's habitual practice to place his hall or staircase in the centre of the house, and depend on a cupola for light and air. So popular did this method become that it was regularly adopted in important houses, and instances of it in houses built as late as the middle of the present century are to be found in various parts of England, especially in Yorkshire.

The one case in which it is inevitable is that of a site bounded by adjacent buildings, or a long narrow site which can only get light at the ends. An instance of the first is given in "Vitruvius Britannicus," vol. iv., Plates 4 and 7, Brettingham's design for the Duke of York's Palace in Pall Mall. The staircase is placed in the centre, and the principal stairs stop at the first floor, above which the staircase chamber is continued without interruption to the lantern, and access to the upper floor is given by a smaller well staircase at one side, in order to avoid any interruption to the light from the lantern above the central staircase. Ware's plan for No. 6, Bloomsbury Square, is more ingenious than Brettingham's. The site is an oblong, and Ware divided this into three unequal parts, the centre being occupied by a staircase up to the first floor as before, with a top light and rooms back and front. Ware, however, instead of making his staircase chamber the full width of the site, has reserved a space at one side which enabled him to provide a passage on all floors from the back rooms to the front, this passage being lit by small circular windows into the main staircase well. For the conditions

of the case this plan is quite admirable, and both here and in other instances the eighteenth-century architects avoided the error of their successors in so contracting the size of the staircase as to make it appear a mere well with a skylight at the top. It is essential, both for light and architectural effect, that the space assigned to a top-lighted staircase should be as large as possible.

The great height given to the principal rooms in eighteenth-century houses has already been referred to. This again was due to the Italian influence. The rules of proportion given by Palladio and others for the various parts of a building were sedulously followed regardless of consequences. In a very high room it is inevitable either that your window must be unduly tall for use, or else so high above the floor that it is impossible to see out of it, or so far below the ceiling that it is unhealthy and very unpleasant to look upon; all of these faults may be found in the designs published by Gibbs and others. Gibbs gives the following rule for the proportion of rooms: "Let length and breadth be added together; half the sum is the height of the room,"—*e.g.*, in a room 20 ft. by 20 ft., the height would be 20 ft.; in one 20 ft. by 30 ft., 25 ft.; and in a room 20 ft. by 40 ft., the height will be 30 ft., in each case one quarter the height being allowed for the cove to the ceiling. The futility of such an abstract system of proportions, without regard to the specific conditions of the case, was apparent to Gibbs himself; for he adds that in England the height of rooms has to be lowered "in regard to coldness of climate and expense," but it should not be less than the width of the room, minus a quarter, for instance, a room 20 ft. wide should be 15 ft. high.

Without discussing further the value of these rules for the proportion of rooms, it is sufficient to point out that in the eighteenth century the size and height of rooms were adjusted to considerations of scholarship rather than of practical convenience, and the disastrous results are evident in the absurd height given to the reception rooms of ordinary dwelling-houses built in the early part of this century, such, for instance, as the typical London house of from 1820 to 1850. So long as such men as Gibbs had to do with the design, it was pretty certain that the result, however inconvenient, would possess a certain academical dignity and distinction; but when the mere formulæ of proportion, ill-understood, came into the hands of the very

inferior architects and builders of the first half of this century, the inconvenience remains unredeemed from dullness by any flash of intelligence or any suggestion of fancy. The one exception to this mechanical system of proportion permitted in the eighteenth century was the great gallery. This, in a somewhat modified form, was allowed to survive from the Jacobean house. The long low gallery, so common in the sixteenth and early seventeenth centuries, with its great range of windows, its pleasant bays, and fretted ceiling, was indeed modified and by no means improved by the increased height given by Vanbrugh and others; but the gallery as an important feature in the house was permitted to survive till the middle of the eighteenth century, and its great length made it impossible to apply to it the exact proportions of the state room and the hall. Gibbs gives no rules of proportion for galleries, except a reference to the double square, though galleries occur in his designs, as, for instance, in Plate XLI. of his "Book of Architecture," which shows a gallery 102 ft. by 25 ft. The only rules that I have come across for the proportion of galleries occur in a curious little book entitled "the city and country purchaser and builder, composed by Stephen Primatt in 1667, and enlarged by William Leybourne in 1680." Primatt says: "The length of galleries ought never to be less than five times their breadth, nor more than eight times. For the height of galleries: if you divide the breadth into three parts, two of them may be for the height, or if higher, divide the breadth into seven parts, and take five of them for the height; both methods are very good proportions." This method of proportion is evidently based on the Jacobean gallery. The gallery at Hatfield, for instance, 163 ft. 6 in. by 19 ft. 6 in. by 15 ft., fulfils it with fair accuracy. Vanbrugh, however, and his successors, seldom observed this rule, and in no instance in the matter of height. The gallery at Castle Howard is 164 ft. by 24 ft. 6 in. high; that of Wentworth Castle, 180 ft. by 24 ft. 30 ft. high; that of Chatsworth, 103 ft. by 30 ft. 22 ft.; and that of Holkham, 105 ft. by 21 ft. 23 ft. The gallery of Bridgewater House, a late example, is 94 ft. by 24 ft. 22 ft. The galleries found in the work of the Adams are, as compared with the seventeenth-century instances, galleries only in name; for, in fact, they are great reception rooms arranged *en suite*, and for purposes of spectacle, rather than the long, low corridor of the Elizabethan house.

Here, as in the case of the living rooms and house planning generally, the tendency of the eighteenth-century architect was to make his design more and more artificial, to remove it from the conditions of actual use and convenience, and to seek for his effect in the satisfaction of certain canons of proportion and design, rather than in the free and unaffected expression of the purpose of his building and his own individuality.

It is to be noted, however, that throughout the eighteenth century a great quantity of excellent domestic work was done, in which the common sense and reasonableness of design is as conspicuous as in any work of the sixteenth or seventeenth century. The passion for a rigorous adherence to the rules of the art was confined to architects of reputation, and though it eventually superseded the old building tradition of the country, there is abundant evidence in many a quiet house in town and country that the simplicity of taste and the kindly humour which gave its charm to the seventeenth-century manor-house was not extinct in the eighteenth century. In the dainty paneling of the hall, the delicate adjustment of unobtrusive detail in windows and cornice, cupboards and mantelpieces, there is more refinement, if less fancy, than in the earlier work, and a precision of workmanship peculiar to the eighteenth century. It would be hard to find in any country a more lovable or more entirely habitable dwelling-house than the plain red-brick house, with its wooden cornice and white sash windows, which continued to be built in England up to about the end of the eighteenth century. It makes no pretence of ambitious architecture; probably it was not the work of an architect at all, but designed and built by some country builder, who had learnt his craft from his father and his grandfather before him, men possibly who had worked under Wren in days when the amateur had not yet usurped the control of architecture. With all our admiration for the knowledge and ability of the English architects of the eighteenth century, one finds the last trace of the English tradition of building not in their designs, but in the unacknowledged work of the country builder, the unpretending endeavour of the architect unknown.

CHAPTER XIII

THE TRADES : CARPENTRY, MASONRY

THE handicrafts, or, to use the old-fashioned term, the trades, that fall within the scope of architecture are so multifarious, that it is impossible in a general history to do more than indicate their main lines of development. Architecture, in regard to the handicrafts, stands by itself. Unlike the other arts, it is the centre and mainspring of a whole family of crafts working together for a total result, which is something much more than that given by any one of them singly. It is essentially architectonic, the master art ; and in the earlier days of architecture, when the arts were far less specialized, architecture did, in fact, embrace all the arts, and the line of demarcation between simple building construction and the work of the artist pure hardly existed. The consequence is that, in considering the history of architecture in England down to the end of the sixteenth century, one is to a certain extent considering the history of all the arts in this country as well. For, in England, at any rate, architects, painters, and sculptors had not as yet detached themselves from the general body of craftsmen, and no one so far conceived of these arts as forming the upper grade in a hierarchy of art. It appears indeed that, while the lower classes treated artists rather as skilled artificers, the Court regarded them as all more or less *βάνανοι*, clever servants degraded by an inferior occupation. Men such as Holbein might be treated with due consideration, but the status and training of the man who painted the frescoes and screens of the great Perpendicular churches of Norfolk and Suffolk were much more akin to those of an ordinary house-painter than to those of the artist-decorator of the present day ; and the sculptor who carved the front of the manor-house or college was also the mason who built its walls. Another point to be noticed in English handicrafts of the sixteenth and

seventeenth centuries is their natural and unconscious development. The changes that occurred came spontaneously, not as the result of fashion or even individual initiative, but as the inevitable consequence of actual circumstance. Architectural methods were largely determined by the physical conditions of the country. Inland transport, except by water, was very difficult for heavy building materials, and the builder was compelled to use whatever came immediately to his hand. The craft of the carpenter in the sixteenth century is a conspicuous instance. Half timber building, though found in almost every part of England, was habitually employed in the great forest districts, such as Essex, in the fourteenth and fifteenth centuries, and in

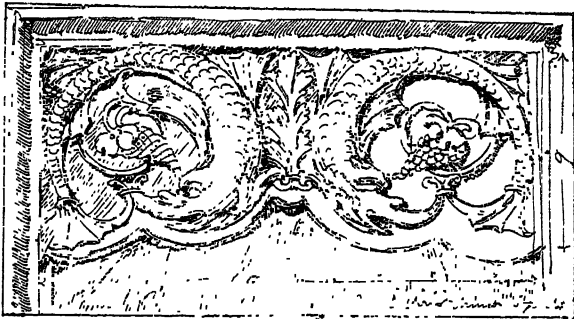

CARVING ON IANEL, CHRISTCHURCH, HANTS.

Lancashire, Cheshire, the Forest of Dean and the Welsh marches, and the Weald of Kent and Sussex in the sixteenth and seventeenth centuries ; and it continued in use in these districts till for various reasons the material was no longer available.

The same conditions prevailed in masonry. Where good building stone was abundant, it was used as a matter of course, and an unmistakable local tradition gradually grew together, which survived repeated changes of fashion ; and here again it is to be noted that, when the change did come, it came by gradual and almost imperceptible stages. The transition followed the inevitable course of events, and in its nature was very different from the violent and deliberate supersession of one style by another, characteristic of modern revivalisms.

Where, for instance, workmen were imported from another district, they brought with them their own ideas of workmanship, and grafted them on to the tradition of the place where they settled. The Somersetshire masons at Wadham are a case in point. By this means a gradual absorption of individual methods was constantly at work, with the result that, as the country was opened up, distinctively local peculiarities merged into a more or less uniform manner, something that it is convenient to classify as a definite style. The history of the development of a national method in English architecture is to a large extent the history of the gradual fusion of local habits and peculiarities into one common custom, a process of long duration, and intimately associated with the social and industrial development of the country. The causes, indeed, which determined the ebb and flow of architecture lay deeper than those which influenced the other arts. Inveterate habit and economical facts had more to do with it than individual motive.

The history of half timber building shows how the development of architecture is controlled in the long run by causes which lie outside the range of art. Strictly speaking, the earlier examples of sixteenth-century carpentry are Gothic rather than Renaissance in character. The old methods in use by the excellent carpenters of the fifteenth century were regularly followed, and the gables, the overhanging storeys, the spurs or angle posts, cusping and tracery, and many a detail of ornamentation show that, in spite of the changes that were imminent, the carpenter followed the mediæval tradition as faithfully as his inferior skill in his craft would allow, and few things are more remarkable in the history of English art than the pertinacity of this tradition. The hammer-beam roof, for instance, survived well into the seventeenth century as a common mode of construction. Yet this was the direct legacy of the fifteenth century, and whatever the ornament in which it was dressed, in spite of cherubs' heads and pendants of grotesques, or pilasters and arches and abundant Renaissance motives, its frank construction and multiplicity of detail reveal very clearly its mediæval origin. The vitality of this particular detail is shown in three characteristic examples: the roof of the hall at Hampton Court, of the Middle Temple Hall, and of the library at Lambeth Palace. The hall of Hampton Court was built 1530-32, after Wolsey's fall. The work was now being carried

out directly for the king, and whether by accident, or as the result of a deliberate intention to reverse the Cardinal's arrangements, all the workmen employed were Englishmen, including the carver. The construction of the roof is in the ordinary late Perpendicular manner. It is very elaborate, and abounds in tracery, panels, and richly moulded ribs and brackets; and, except for the coarseness of the detail and a certain forced ingenuity of design, this roof might have been constructed a hundred years earlier. In the carving, however, the Gothic precedent was entirely abandoned, and the carver gave an exceedingly interesting version of Italian detail as seen by English eyes, and yet the inherent conservatism of English thought was tenacious and victorious. Though the carver at Hampton Court proposed to himself an Italian model, he was as much bound by tradition as the man who made the roof, and the *naïveté* of his method, his failure in grace and suavity, show how far he was from being really penetrated by Italian thought, and for many generations the English craftsman remained at heart an inveterate mediævalist. In the seventeenth century, when the carpenter was left to his own devices and there was no question of carving, as, for instance, in the roofs of some of the college halls at Oxford, he simply repeated the details and construction which had been in use in England for the last two hundred years. So deeply rooted were the old ideas of timber construction, that in technical handbooks published at the end of the seventeenth century the principal rafters of a king-post truss are shown with a spreading foot. Now in timber sawn out of straight balks this would involve great expense and waste of material. The explanation is that this was taken from the old method of following the natural angle of branches and trunk in cutting roof timbers from the tree.

The hall of the Middle Temple was built 1562-72. The principals here have double hammer-beams, otherwise the construction follows generally the lines of the Hampton Court roof; but the details are no longer Gothic, the mouldings are ordinary classic of the time, and instead of the cusping and tracery to the spandrels, there are small turned columns, and above the collar-beam these columns have pedestals.

The roof of the Great Hall at Lambeth is a most interesting throw-back to the original type. The date is just a hundred

years later than the Middle Temple roof, yet it deliberately reverted to Gothic detail. The old hall, built by Chichele, was destroyed by Scott the Parliamentary in 1648. On the

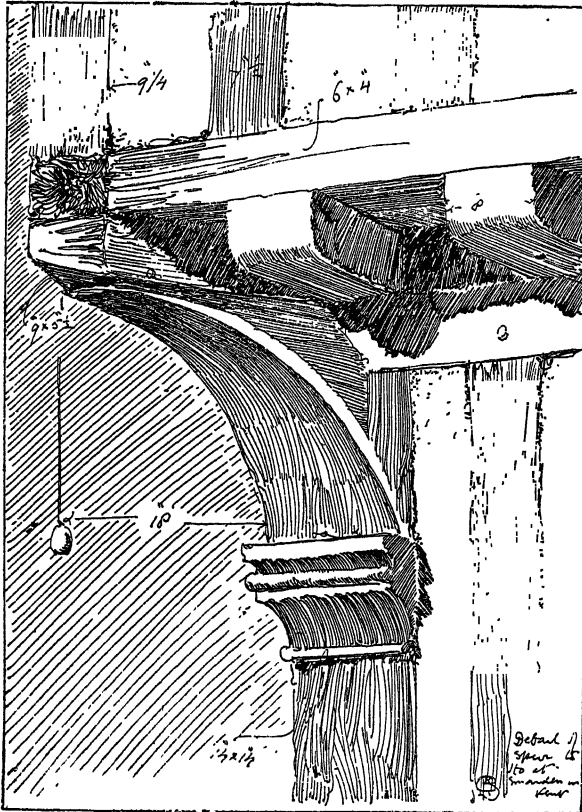

A SPUR, SMARDEN, KENT.

Restoration, Archbishop Juxon decided to rebuild the Hall, and Aubrey relates that, in spite of the persuasions of his friends, he insisted on its being rebuilt as closely as might be on the original lines. The principals have an upper and lower

collar-beam, and beneath the lower collar comes the hammer-beam and post with a great semicircular rib carried right across from corbel to corbel under the lower collar. Supplementary pieces framed into the soffit of this rib form a huge trefoil cusp, the spandrels are filled in with upright posts with cusped heads, and the braces under the purlins have tracery in the spandrel. Curiously enough, the panelling to walls and door frames is ordinary classic of the Restoration, while the roof is Gothic, so that it seems as if Juxon's directions had less to do with it than the idiosyncrasies of the carpenter who constructed the roof, and the joiner who made the panelling. The mediæval tradition survived in construction long after it had died out in ornamental detail.

The spur or angle post of the half timber houses of the sixteenth and seventeenth centuries shows the same instinctive conservatism. This was a familiar feature in mediæval domestic architecture, and there are still a few instances left, as at King's Lynn, Bury St. Edmunds, and Shrewsbury, and the beautiful example at Lavenham in Suffolk, to show the extreme care lavished on its ornament. As a method of construction, the spur, with its accompanying system of floor framing, continued in use till the time of Charles I., and by constant experience of its practical purpose the sixteenth-century carpenter was able to give it a form which was not only more efficient, but more beautiful in shape than the elaborate mediæval angle post. Instead of a square balk bending outwards he shaped the upper part into a complex curve, which does not occur elsewhere, and is, I believe, peculiar to English half timber work of the sixteenth and seventeenth centuries—instances are common in the half timber buildings of the Weald of Kent and Sussex.¹

¹ The finest examples of half timber building in Lancashire are Baguley, Morton Old Hall, Speke Hall, Smithells, and Agecroft. Stanley Palace or Derby House, in the Watergate, Chester, dated 1591, is a good late sixteenth-century example; other instances will be found in Taylor's "Old Halls in Lancashire and Cheshire." The Gate House of the Council House at Shrewsbury, date 1620, is characteristic of west-country work in its richness of detail. The houses in the Weald of Kent are smaller in scale, but more refined in design than those of the west country, and most of them date from the early part of the seventeenth rather than from the sixteenth century. Good examples are to be found at Headcorn (fifteenth century), Singleton and Beavor, near Ashford (sixteenth century), Lenham, Biddenden, and Cranbrook (seventeenth century). The example in the text exists at Smarden in Kent.

But with this modification the spur remained essentially Gothic, and, with the construction of which it formed a part, continued in use until for other reasons half timber construction was generally abandoned. The actual reasons which led to the disuse of half timber building had nothing to do with architecture. In the Weald, for example, attention was called to the gradual diminution of the timber supply as early as the reign of Edward VI. In 1549 the Mayor of Rye reported to Somerset on the scarcity of timber occasioned by the iron mills; and in 1573-74 Christopher Baker made a report on the great consumption of oak wood in Sussex, Kent, and Surrey by the iron mills and furnaces, and returned a list of all furnaces and owners in the three counties. Serious alarm was felt as to the supply of timber available for ship-building, and oak timber ceased to be a cheap and convenient building material. The result was that half timber building fell out of use about the time it had reached its full maturity. The disappearance of half timber building in the middle and west of England at about the same date was partly due to a similar cause. Camden mentions that the Forest of Dean, which was almost impenetrable in the reign of Henry VI., was in his time very much thinned, owing to the discovery of the rich veins of iron in the forest. In Essex, by the middle of the seventeenth century, a large part of the county had been disforested and reclaimed as arable land.

The change of style, the abandonment of Gothic that is, came first in details, and did not extend to construction till the middle of the seventeenth century. From ornamental detail the change spread to actual construction. Sir Paul Pindar's house, which used to stand in Bishopsgate Street,¹ marks the point of transition. The front of this house, built early in the seventeenth century, was, in fact, one immense bay window in two storeys, with cartouches carved in panels below the sills, and might have been transplanted wholesale from an ordinary Elizabethan house. Sparrow's house at Ipswich, a most remarkable example of timber construction freely decorated with plaster work, carries the development a stage further. The first floor overhangs the ground floor considerably, and is supported by a series of elaborate balusters with carved brackets and swags on the frieze between.

¹ The front is now in the South Kensington Museum.

On either side of the bay windows on the first floor are pilasters on pedestals; these, however, are merely surface de-

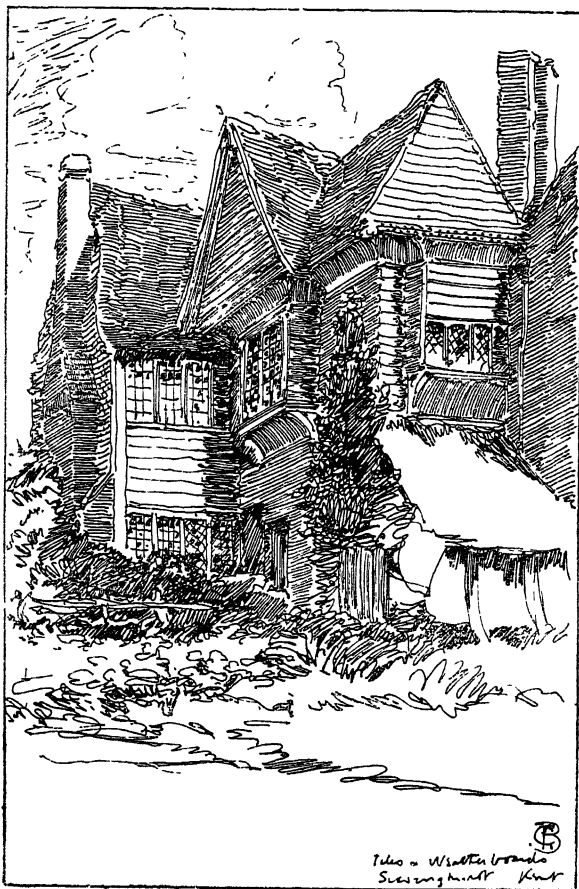

WEATHERBOARDED HOUSE, SISSINGHURST, KENT.

coration, and play no part in the construction. They run out into the flat soffit of a great projecting cornice, which is

carried along the entire front and sides with shallow returns above the centre of the bays. The level lines and broad, deep shadows of this building show that the designer was getting away from Gothic architecture, and beginning to realize the constructional possibilities of Classic; and the next step forward was to use columns and entablatures with full consciousness of their intention, as in the colonnade to the courtyard at Knole. After the middle of the seventeenth century timber buildings were constructed as frankly neo-classical in design as any contemporary masonry or brickwork. Not only in the profiles and mouldings, and the use of columns and lintels for their legitimate constructive purpose, but in a general horizontality of treatment, these buildings show that the carpenter had at length assimilated the new ideas, and had got beyond the stage of merely plastering classical details on Gothic construction, characteristic of Elizabethan and Jacobean architecture. The course of development is indicated by some of the town halls of the sixteenth and seventeenth centuries. The Market Hall of Ledbury consists of a ground floor open on all sides, and an upper floor inclosed with oak studs and plaster work. It is a perfectly plain building of timber, with practically no ornament: such mouldings as remain suggest that it was built between 1500 and 1550, possibly later; and, in so far as it has any distinctive character, it is a good example of vernacular Gothic carpentry. Early in the seventeenth century Abel designed and built the Town Hall of Leominster, already referred to. The general idea of this building, both in plan and general construction, followed closely the Ledbury precedent, but Abel introduced a great quantity of rude ornamental detail, based, so far as his knowledge would permit, on Renaissance motives. But this was merely the beginning of the change; its full intention was not yet assimilated, and the organic alteration of the style was not completed till the latter part of the seventeenth century, when, as in such instances as the Guildford Town Hall, or No. 413 and 415 in the Strand, both construction and ornament were designed together. The designer was now capable of more than mere haphazard phrases borrowed from another language, he thought in terms of neo-classical architecture; after long years of experiment he had worked out a coherent and flexible style for the expression of his ideas. For various reasons, such as the scarcity of timber and the increased attention paid to

building regulations in the large towns, it was at this very period that half timber architecture disappeared ; few buildings of any



SPARROW'S HOUSE, IPSWICH.

importance were constructed of timber after the end of the seventeenth century. The carpenter-architect, who designed

and executed his own work, had ceased to exist ; architects had detached themselves from craftsmanship ; and the result was that, though the tradition of good workmanship was carried on into the eighteenth century, the work of the carpenter was specialized and limited to constructive details, and the joiner and the wood-carver divided between them all the work that required exact skill of handicraft. It is almost certain that Abel in Herefordshire, Holt at Oxford, and Woodroffe at Cambridge, designed as well as executed their roofs and screens with all their ornament ; but later in the seventeenth century we find Austin undertaking joiner's work only, and Grinling Gibbons and his school employed solely for the carving. The result was an immense advance in technical skill and accomplishment, but the worst of all specialization is that it narrows the outlook of the specialist ; the inevitable tendency is to concentrate attention on one special branch of workmanship, without regard to the large effect of the whole ; and though the joiners of the end of the eighteenth century were fully equal in technical skill to the men who worked under Wren, their work had lost the large architectural quality shown by the earlier men. It became thin and wiry, a fault not solely due to the general decadence of architecture, but probably inseparable from this excessive specialization. A comparison of any staircase executed in the last thirty years of the eighteenth century with the fine bold detail of a hundred years earlier will show the extent of this degeneration, and much the same changes are to be found in other details of woodwork, such as panelling. Starting in the sixteenth century with Gothic motives, such as the linen panel and the like, panelling passed through the stages of the small and delicately moulded oblongs of the time of Elizabeth and James I. to the bold simple panels of Inigo Jones and Wren. In their hands the whole treatment of decorative woodwork was altered ; the chief excellence of Jacobean panelling had been the refinement of its details and its surface quality ; it took the place of tapestry, and, as a means of artistic effect, might almost be considered as interchangeable with wall hangings. It might or might not be richly carved, but its intention in any case was to give a uniform and continuous background. The larger panelling of Inigo Jones and Wren was designed from an altogether different standpoint : its disposition of lines formed part of the architectural composition, it had to be considered with

reference to the same standards of architecture as the rest of the building, and in this regard required a sense of proportion and a power of selection and reserve undreamt of by the

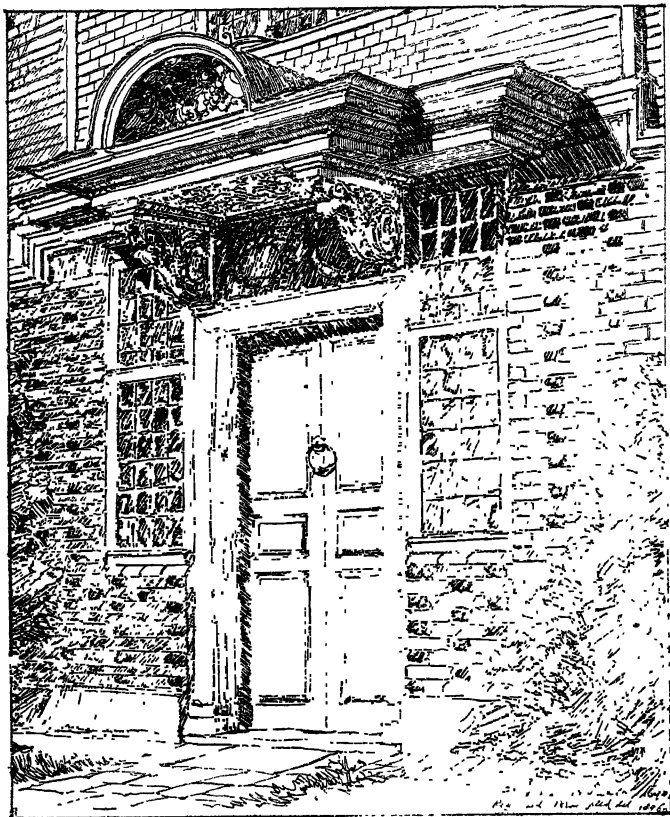

DOORWAY AT BURWASH, SUSSEX.

Jacobean designers. The panelling in Wren's buildings at Hampton Court, and in the staircase of Ashburnham House, show how greatly panelling had gained in breadth and distinc-

tion of style by the end of the seventeenth century, and this high standard of attainment was well maintained in the earlier half of the eighteenth century; but when designers began to refine upon earlier work, they discarded panelling for stucco ornament, and the details of their joinery became petty and insignificant. The sense of woodwork as woodwork capable of effects peculiar to itself was forgotten—as with the other crafts of architecture, by the end of the eighteenth century, architects had lost their touch of material.

The physical conditions which influenced carpentry were at work in the handicraft of masonry in an intenser form. The oak or chestnut of one district in England does not vary to any appreciable extent from that of another, but there is the widest possible difference in its building stones, not only in their strength, and ease or difficulty of working, but in the sizes obtainable and the texture and surface which they are capable of receiving. Style and material react on each other in masonry to a remarkable degree. For instance, a correct Palladian design requires stones dressed to a particular shape and size, and the effect depends partly on the accurate proportion of the individual stones as set out on his drawing by the architect. Now it would be impossible to carry this out in a laminated stone, which runs in lengths varying in thickness, but never exceeding a few inches in depth. It can only be properly executed in a freestone admitting of blocks of any practicable size, such as Bath or Portland stone, and this fact accounts for the almost universal employment of Portland stone in important buildings of the time of Wren, and of Bath stone in the century following. Where, on the other hand, only thin-layered stone was obtainable, the builder was forced to abandon the orthodox manner, and to follow approximately the old tradition of gables and rough coursed walling, such as is common in Oxfordshire; and so great is the influence of material on design in masonry that, in districts such as Oxfordshire, the tradition of the seventeenth century can still be traced in common buildings erected within the last fifty years. Mr. Gotch says of Northamptonshire: "Quite into the eighteenth century we find in small buildings the same forms that prevailed at the end of the sixteenth century"; and even in the mill architecture of the Yorkshire manufacturing towns, harsh and forbidding as it is, there remained a certain local quality and some of the dignity of the eighteenth

century in buildings erected as late as 1840. Local peculiarities, in fact, are more strongly marked in masonry than in any other

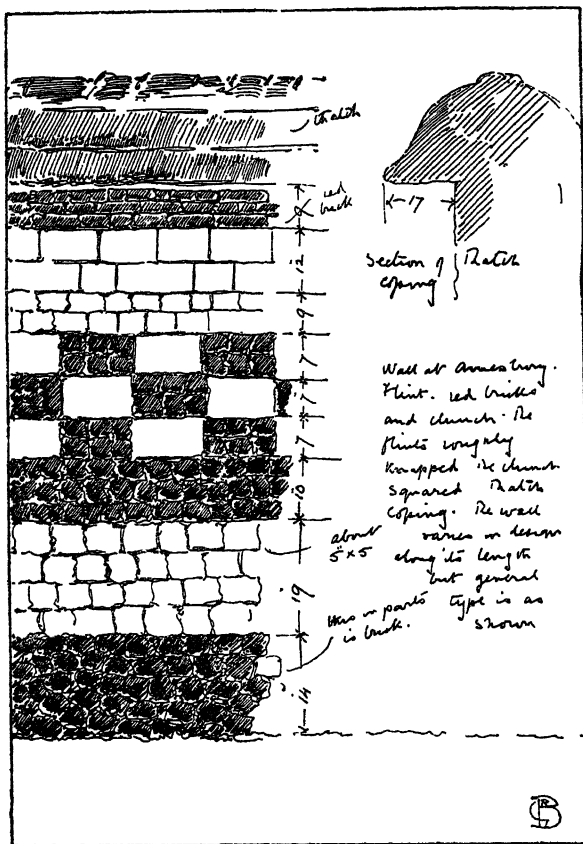

WALLING AT AMESBURY, WILTS.

trade. There is no mistaking vernacular work of the seventeenth century in the North: with its long, low windows, massive mullions, often unpleasantly close together, its rudi-

mentary ornament, and extreme solidity of construction. Partly this was due to the difficulties of working the hard Yorkshire stone, partly to the necessities of a severe climate, partly perhaps to the nature of the northerner, somewhat insensible to refined design, but keenly alive to actual facts. Contrast this with contemporary work in the south of England and the difference of temperament and conditions is evident. The mullions do not crowd upon each other as in the north country windows, the roofs of tiles or small stone slates are steeper, and the gables more fanciful because their form was not determined by any such obstinate materials as the great flagstone roof-coverings of Yorkshire. Altogether the impression left is that of a freer and more genial life, of conditions in which there was room for some kindlier play of humour, some regard to the grace of life beyond the strict necessities of existence. In this vernacular work, work, that is, which grew naturally out of local conditions and was not dictated by imported design, one always finds the same three elements at work: local materials, local conditions of climate, and individual temperament; and some curious instances of this are to be found in out-of-the-way parts of England, as, for instance, in the singular gateway of Lanhydrock in Cornwall (1650), in which the details are outside classification, and appear to result from the use of granite and the working of a somewhat backward intelligence. The squared work of flint and stone, such as is found in the Guildhall at King's Lynn, or again at Amesbury, Longford Castle, Stockton, Lake House and elsewhere in Wiltshire, or in East Kent, is another example of work entirely dictated by the actual materials to hand. Nor was this natural growth of style in masonry by any means confined to the sixteenth and seventeenth centuries. In the eighteenth century, great stone districts, such as that of Bath, developed their own particular traditions; at Bradford-on-Avon and in the neighbourhood may be found details almost peculiar to this part of England, and derived not from the deliberate designs of architects, but from the more or less unconscious initiative of local masons. I give an instance of a doorhead from Corsham; simple as it is, this is not based on any precedent, but is clearly the result of this process of natural development which I have endeavoured to suggest, and though it is useless to speculate on what might have been, it is a matter for regret that in these and other details where a strong local

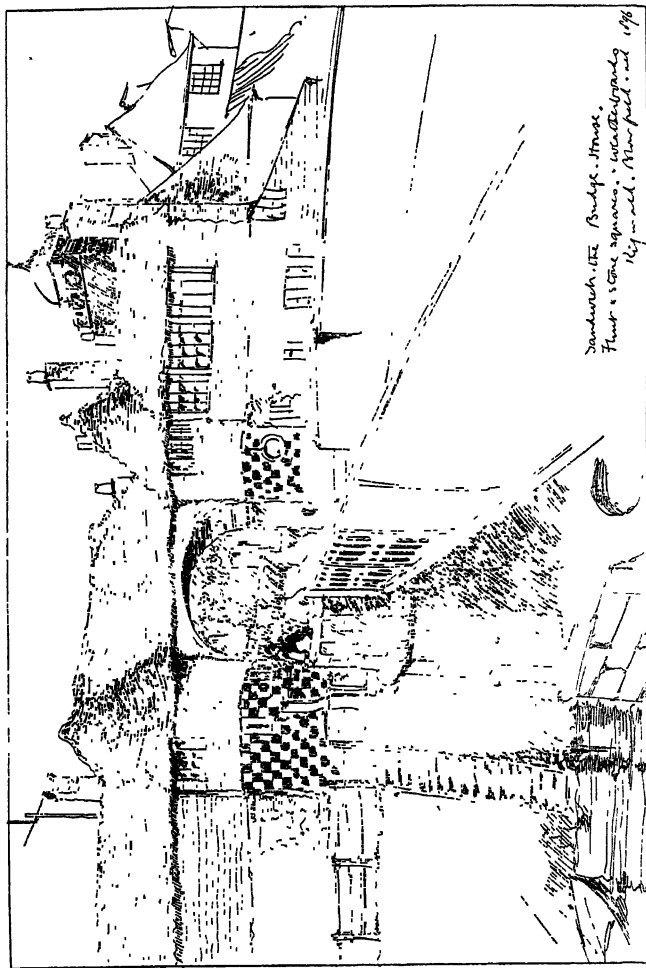

Sandwich - the Bridge House.
Flour & Stone square - water tower
High - old. New field - 1876

GATEHOUSE, SANDWICH.

tradition prevailed, builders should have abandoned it in favour of prevailing fashions of detail which they probably misunderstood, and certainly habitually misapplied. This fact is very clearly seen in modern buildings in Yorkshire, where the less important stone buildings in the towns have every fault which it is possible to combine in a design, whereas the farm buildings erected far away on the moors, with no idea beyond that of providing shelter against the wind and rain, still adhere to the old traditions, and have a very distinct individuality.

It is, in fact, to these humbler buildings, cottages, farms, farm buildings, and the like, that one has to look in order to trace the permanent building tradition of the country. Individually they are unimportant, but considered together, they acquire a distinct significance, forming as it were a background to the more conscious architecture of trained designers, and giving it colour not only through the peculiarities of local methods of workmanship, but also through the influence they inevitably exercise on the minds of any but the most arbitrary or least observant of architects. This influence is very much weaker now than it was 300 years ago. In proportion as architecture became more exact, that is, more a matter of knowledge and training than of strong individual impulse, the architect detached himself from the builder, and neglected the admirable groundwork of ideas to be found in his own country in favour of foreign motives. And it is to this fatal severance of architecture from building that we owe the uninterrupted succession of revivalisms of the last hundred years. Architects have, in fact, deliberately debarred themselves from the most certain means of attaining style, that is, of placing themselves in touch with all that is of permanent value in architecture, by substituting the crude expression of their own individuality for the assured tradition which results from the persistent tendency of generations, and in more recent years by suppressing even their own individuality in favour of direct and literal copy. These considerations, however, apply to some of the Elizabethan designers not less fully than to architects of the nineteenth century. I have already pointed out how the first introduction of the Renaissance in England was limited exclusively to ornamental detail, with results which, so far as they went, were charming. But the men who designed for the great noblemen of the time of Elizabeth and James I.—possibly the great

noblemen themselves—were too vainglorious of their recent knowledge to rest content with this. They piled order above order, and entablature above entablature, without the least regard to the tradition of their own country, or with any understanding of the art of the great masters whom they copied.

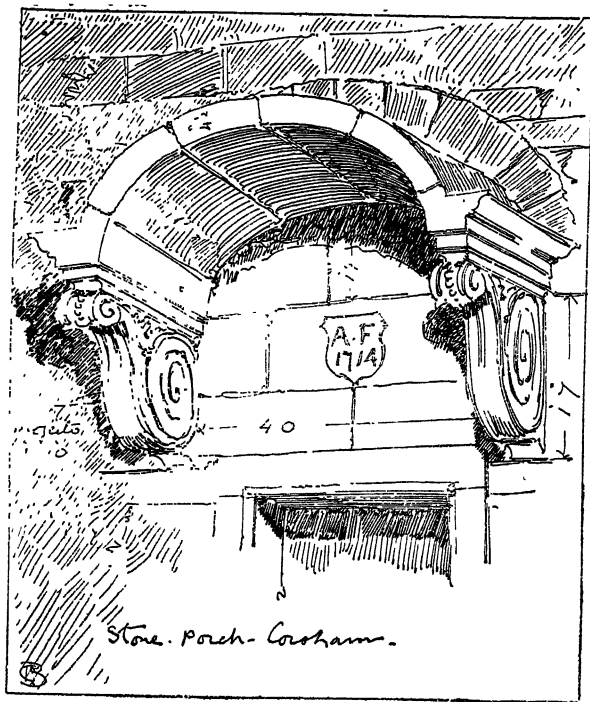

STONE DOORHEAD, CORSHAM.

The consequence is that the most ambitious of these palaces, such as Audley End and Wollaton, are the worst pieces of architecture to be found in England during the reigns of Elizabeth and James I. Contrast these with such buildings as Blickling and Burton Agnes, or Littlecote, Wakehurst, and parts of Knole, and the value of the traditional method is evident.

For good or for bad, however, this method was continually losing ground and the foreign fashion taking its place. Fortunately for the future of English architecture the new departure was taken up by Inigo Jones, and he, with the instinct for simplicity and hatred of disorder inherent in genius, swept away this redundant ornament and confusion of motives. He was the first to introduce the single order on a rusticated basement, such as is used in the houses on the west side of Lincoln's Inn Fields, and instead of playing with entablatures, used them with serious regard to their original functions. He designed in fact in neo-classic instead of merely applying neo-classic ornament to another design. As the result of this radical innovation a change speedily followed in details. The stone mullions and transomes disappeared soon after the middle of the seventeenth century, lingering on in conservative places such as Oxford, as, for instance, at the Ashmolean, and the oblong window took its place, glazed at first with casements, wooden mullions and transomes. These were superseded by the sash window early in the reign of William III., and in the earliest instances the sash bars reproduce the mouldings of the old mullions and are almost thick enough to carry a casement. This change in fenestration is the final sign of the abandonment of the earlier phases of the Renaissance.

With the mullioned window also disappeared the strapwork parapet, as at Hardwick, and the succession of small entablatures with which the Jacobean builders divided up the different storeys. The diminutive mouldings of these orders, often correct as far as they went in scale and profile, but ridiculously out of scale with the buildings as a whole, were superseded by bold entablatures proportionate to the increased dimensions given to the column. A certain impatience with the pettiness of Jacobean work, with what Evelyn called "our busie and Gotic triflings in the compositions of the five orders," seems to have become general before the middle of the seventeenth century, and so long as this feeling was guided by master minds, such as Inigo Jones and Wren, its influence on English architecture was entirely good, and it succeeded in restoring to it something of the reasonableness of the older tradition. For the first time since the building of the chapel at King's, architecture in the great manner, work, that is, which was impressive not merely by its size, but by the distribution of its masses, was again carried out

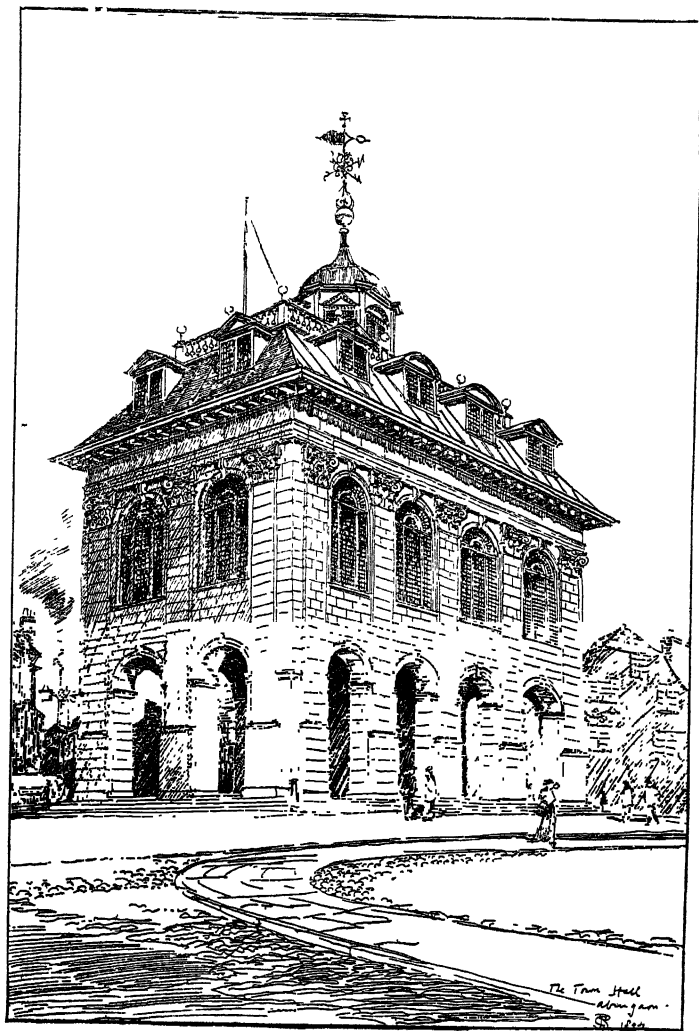

ABINGDON TOWN HALL.

in England, and the mason himself, if no longer allowed to design as in the days of Symons and Wigg, gained in technical skill by being limited to the actual handiwork of masonry. When Wren began to practise there were already to his hands masons trained under the severe discipline of Inigo Jones, who were capable of executing classical detail with exact knowledge ; and under the influence of Wren and his successors, there grew up in England a school of masons of unrivalled skill, men such as the Strongs who built St. Paul's, who were capable of dealing with the most difficult problems of stone-cutting with absolute mastery. And, indeed, the architects of the early part of the eighteenth century were by no means sparing in their demands on their masons. Wren, who was essentially sane, could show his men the way out of any difficulty ; but towards the end of the seventeenth century a sort of megalomania seems to have set in. Neither Vanbrugh nor Hawksmoor could ever get their orders big enough to please themselves, and he could have been no apprentice who carried out the monstrous masonry of Blenheim, or the huge order of the old Clarendon Press, in which the diameter of the columns to the portico is 3 ft. 10 in. ; or of the Christ Church Library, where Clarke, with the ambition of the amateur to break the record, made his Corinthian columns 4 ft. in diameter. Only very skilful masons could execute these grandiose designs without risk of failure. Their expense and difficulty probably led to their abandonment, and the order gradually shrank in its dimensions till it dwindled to the flat strips of pilasters used by Adam. Meanwhile, architects had introduced all sorts of variations into the orders. Adam altered the entasis and designed new capitals to the columns. The older pattern-books became obsolete, and the new fashion for Greek architecture towards the end of the eighteenth century completed the bewilderment of the mason, and at length obliterated the fine traditional sense of classical detail once possessed by any well-trained mason in England.

Thus the mason had lost the knowledge of his craft and come to be entirely dependent on the directions of architects ; and the mason-architect of the seventeenth century had finally disappeared. Grumbold at Cambridge was one of the last. His father, Thomas Grumbold, who was paid as a working mason in 1638-39, supplied a draught of Clare Bridge, for which he received 3s. ; and in 1669 Robert Grumbold, the son, Free-

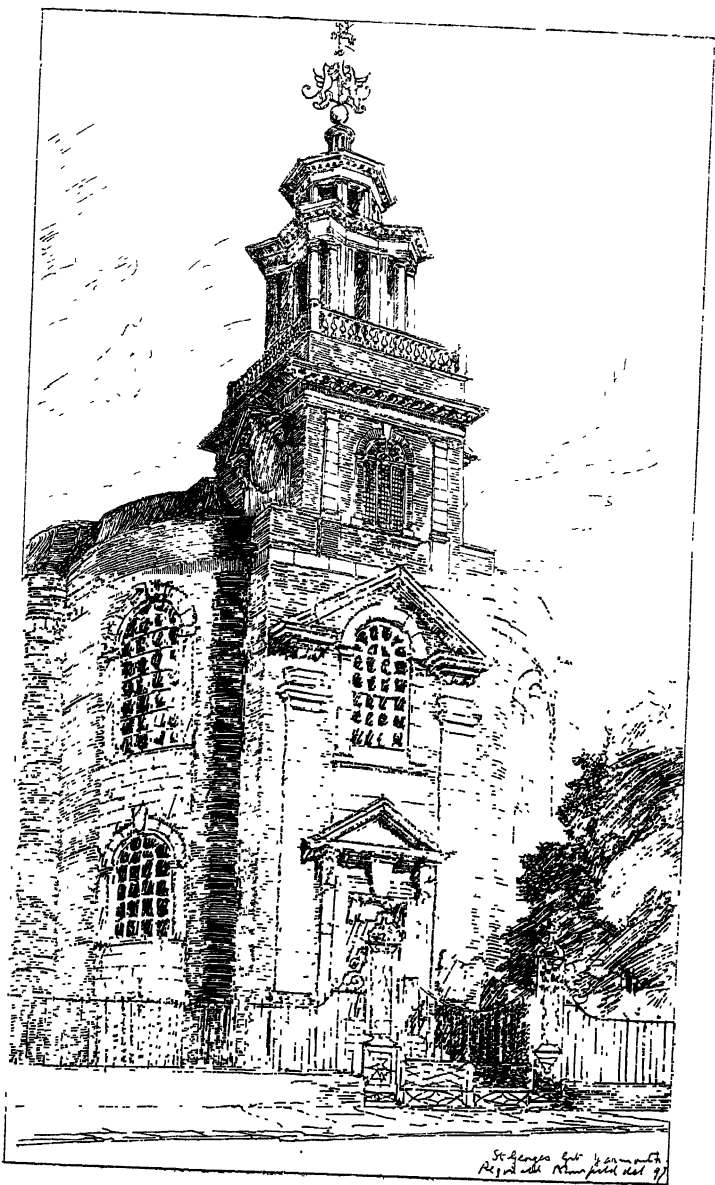

ST. GEORGE'S, GREAT YARMOUTH.

mason, was employed to design and carry out the beautiful river buildings at Clare. In 1685 he was being paid at the rate of 20s. a week for his designs and his work as master mason, the college finding all materials; and about the same time he appears to have designed the west front of St. Katherine's, Cambridge. Little is known about Grumbold except that he was both mason and architect, but there must have been other men of the same stamp at work in England till the middle of the eighteenth century. In 1714 the Corporation of Great Yarmouth decided to build the Chapel of Ease of St. George. A committee of local gentry was appointed, and the work was contracted for by a builder of the town named Price; no architect was employed—the design was made by Price, and it is evident that the committee had nothing to do with it, for it was proposed that the Church of St. Clement Danes should be taken as a model, to which building the Chapel of St. George bears not the slightest resemblance. It is built of fine red bricks with stone dressings, now covered with paint, and at the west end is a picturesque tower with an open belfry over it in two stages, surmounted by a cupola and an open ironwork vane. In so far as Price imitated any building, his design was inspired by the late seventeenth-century towers of some of the Dutch town halls. There are certain technical defects in some of the details, but with this exception the work is not inferior to what was being done by professional architects at the time. The charming little Hospital for Decayed Fishermen, built by the Corporation of Great Yarmouth in 1702, is another example. The name of the designer of the Town Hall at Abingdon (1677) is unknown. The skill and knowledge displayed make it improbable that this was designed by a mason only, yet there are other buildings, such as the Town Hall of Wallingford, of a simpler character, but hardly less excellent, which were quite within the competence of any good builder of the time. It seems likely, indeed, that in places far away from the big towns, we ought to look to the local builder (mason or carpenter) rather than to any architect as the designer of buildings, by no means the least charming or important among the remains of English eighteenth-century architecture, and for the last trace of that traditional skill which enabled the mason of the seventeenth century to carve his stones as well as to lay them, one must search among the headstones of village churchyards.

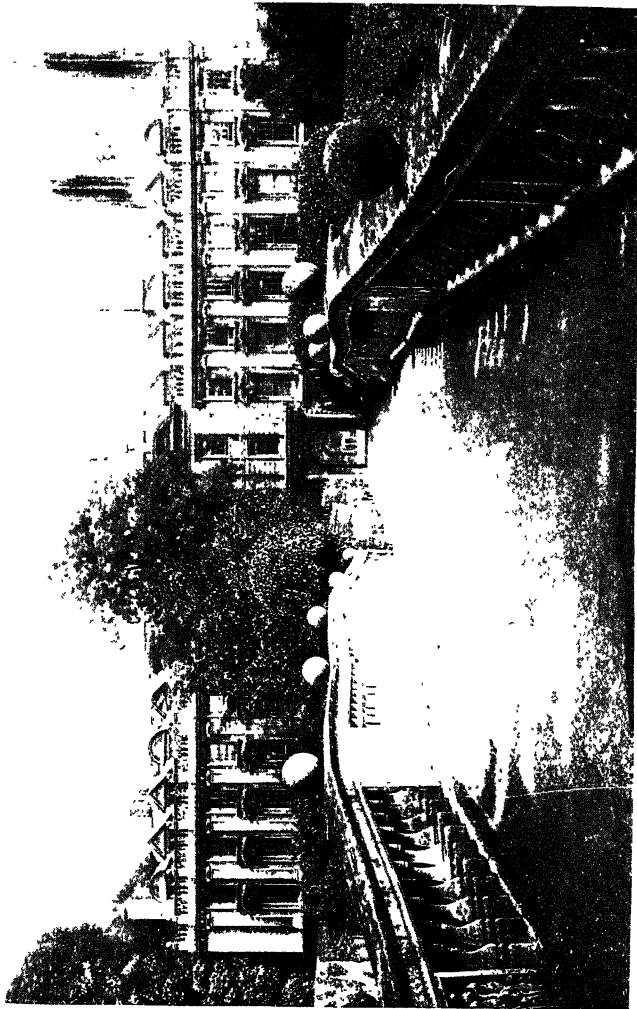

Wilson, Aberdeen, photo.

CLARE COLLEGE, CAMBRIDGE.

(Photographs and drawings by ...)

Something of the playfulness and poetry of the Elizabethans still lingered in the country, and while Artari and Bagutti were modelling conventionalities in stucco for Gibbs, the stone-mason at Dorchester was cutting on his tombstones the mallows and forget-me-nots of the meadows round his home.

CHAPTER XIV

BRICKWORK, PLASTER WORK, LEAD, AND IRON

THE reintroduction of brickwork into England was probably due to two causes, first, to the scarcity of building stones in the eastern counties, and secondly, to the large immigration of Flemings into the neighbourhood. The inhabitants of the Netherlands had long been skilful in the use of brickwork. Their country was destitute of stone, and brick was, in fact, almost the only building material available. Much the same conditions prevailed in the eastern counties. The fact that it was in Norfolk and Suffolk that brickwork was first used again since the date of the Roman occupation, that these were the counties which received the earliest Flemish settlements, and that the dates of these settlements and of the reintroduction of brickwork almost coincide, make it probable that we owe the revived use of brickwork to the Flemish immigrants, and that in the earliest instances the bricks themselves were imported from the Netherlands.

As early as the reign of Edward I. (1272-1307) Flemish wool manufacturers and weavers settled at Worstead in Norfolk. Further settlements of Flemings were made at Hadleigh and Sudbury in the reign of Edward III. After that reign they became common throughout the eastern counties, and wherever the Flemings settled distinct traces of their influence are found in the brickwork of the neighbourhood. The earliest instance of the use of brickwork since the Roman occupation is said to be Little Wenham Hall in Suffolk, supposed to have been built after the middle of the thirteenth century. Other early instances are the Chapel Barn at Coggeshill, Essex (thirteenth century), in which the jambs, mullions, labels, and arches of the windows are in moulded bricks; the transepts of Holy Trinity Church, Hull (1315-20), and chancel (1340); and the gallery of Thorn-

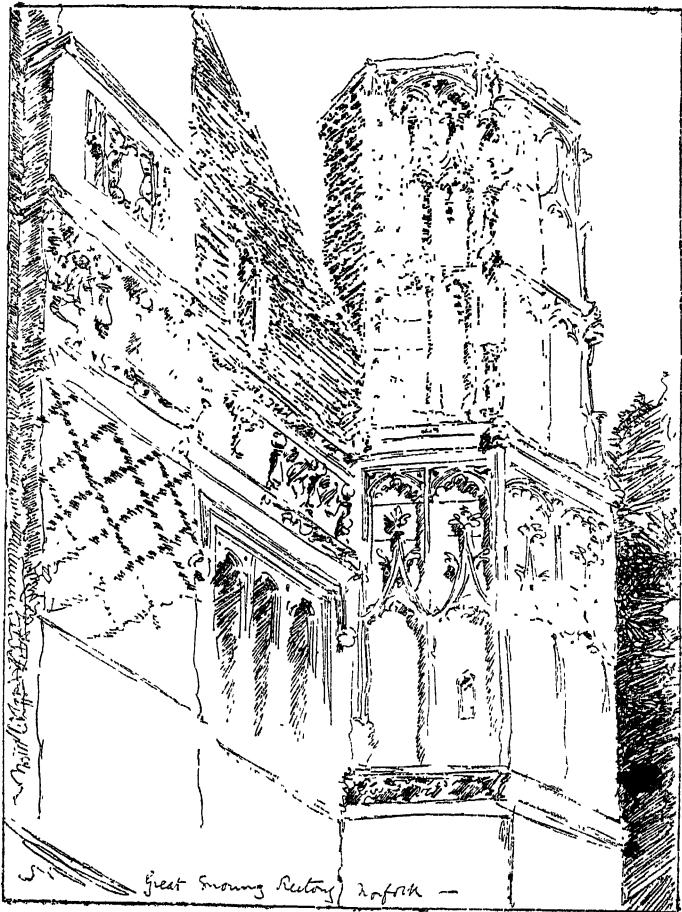

GREAT SNORING RECTORY, NORFOLK.

ton Abbey, Lincolnshire (1380).¹ The north-east angle tower

¹ I am indebted to Mr. John Bilson, of Hull, for some valuable information on this point. Mr. Bilson considers that there is no evidence to show that the reintroduction of brickwork was due to Flemish influence. On

of Faulkourn Hall, near Witham, is said to date from the early part of the fifteenth century, and the north and east ranges of Queen's College, Cambridge, were built in 1448. The bricks at Queen's vary in size from 8 in. by 2 in. by $4\frac{1}{4}$ in. to 8 in. by $1\frac{3}{4}$ in. by 4 in. They are burnt extremely hard to a dark purple red, as in the older work at Hampton Court, and in some cases the headers have vitrified yellow ends. They are very irregular in shape, but as hard as the hardest tile. The joints are wide, and the brickwork measures $11\frac{1}{2}$ in. from centre to centre of four courses. Caister Castle, near Great Yarmouth, built by Sir John Fastolf, and afterwards held by the Pastons, is of much the same date as Queen's, and is built entirely of brick. Some thirty years later Oxburgh Hall, near Swaffham, was built by Sir Edward Bedingfield in 1482-83. It was originally a quadrangular house, with a crenellated and machicolated gateway 80 ft. high, all in brickwork. The gateway and the main buildings of the splendid ruin of Hurstmonceaux, in Sussex, are of much the same date as Oxburgh. Stone is used in this very sparingly for the dressings, and the walls are built of fine red bricks, measuring about $9\frac{1}{4}$ in. by 2 in. by $4\frac{1}{2}$ in., and about $10\frac{1}{2}$ in. centre to centre of four courses. Great Cressingham Priory, not far from Oxburgh Hall, a remarkable instance of brick moulded panel work, was built in 1513, a little earlier than Wolsey's work at Hampton Court. The brick and terracotta work of East Barsham Manor House and of Great Snoring Rectory has been already referred to in Chapter I. Both of these houses, which date from the early part of the sixteenth century, are richly ornamented with tracery and panels, and terra-cotta ornament. Their style is late Perpendicular, with distinct traces here and there of Italian ornament. In brickwork, as in carpentry and masonry, the transition to Renaissance art crept in by slow degrees in detail. Constructional features, gables, chimney-stacks, angle-turrets, and gateways preserved the mediæval manner long after it had been abandoned in

the other hand, the facts (1) that there is no evidence of the use of brickwork before the reign of Edward I., (2) that its first appearance in the eastern counties was subsequent to the settlement of Flemings in those counties, or rather almost coincident with their arrival, incline me to adhere to my original view—that the reintroduction of brickwork was due to the Flemish immigrants. When the trade was once started, it rapidly developed; and Mr. Bilson has pointed out to me that from 1303 onwards the town of Hull had its own brickfields, of which the accounts are still in existence.

the details of their ornament, and in the earlier instances one usually finds that some exceptional influence was present to account for the introduction of foreign motives. Sir Richard Weston, for instance, the builder of Sutton Place, was a distinguished servant of Henry VIII.; so were the builders of Layer Marney and the Vyne. In all these cases the owners were men who had travelled much, and had seen something of the beautiful work then being done abroad, and there can be little doubt that the new fashion in ornament was introduced by their direction rather than on the initiative of the actual workmen. The presence of foreign artists in England rendered such a departure possible. Terra-cotta was only used with any freedom so long as the Italians were present in England. It never took its place as one of the building materials of the country.

In the sixteenth century the influence of the Flemings was by no means confined to Norfolk, Suffolk, and Essex. Large immigrations of Flemish artisans occurred in east Kent in the sixteenth century, and the earliest example of brickwork in this part of England besides Hurstmonceaux, is probably the little corbie chapel of Small Hythe near Tenterden, which has the corbie steps to the gables common throughout the eastern counties, and almost certainly Flemish in its origin, and good simple brick tracery to the windows such as is commonly found in Holland. This chapel was probably built early in the reign of Henry VIII. Another example is to be found in East Street, Rye, a house built of small yellow bricks, varying in colour from light yellow to pink, resembling what are now called Dutch clinkers, and almost certainly imported from Holland. Exactly similar bricks, baked out of river mud, are to be found at Dort, Gouda, and other towns of Holland. They are also found in the interior of Camber Castle, one of the castles built by Henry VIII. to defend the entrance to the old harbour at Rye. A few examples are to be found at Sandwich, and one very remarkable instance in Delf Street which reproduces exactly the Dutch house of the sixteenth century, and was no doubt built by one of the Walloon silk weavers settled in Sandwich. This house has stone quoins at the angles, and the walling consists of alternate bands of stone, black knapped flints, and small yellow bricks. The window openings have elliptical arched heads, all flush, the soffits shaped as large cusps and built of alternate

voussoirs of small red and yellow bricks. The Dutch original is reproduced in the rich iron wall ties and the large detached iron letters giving the date 1616 with a monogram W. O. in the centre. This, though a late example, is very characteristic of the Flemish manner as adapted to English materials.

By the middle of the sixteenth century brickwork was fairly established in England as an important building material. It took the place of stone where the latter was scarce, or was used to form the walls, the stonework being reserved for strings and dressings and ornaments, as at Hatfield, Blickling, Bramshill, Shaw House, and elsewhere. Though employed at first in conjunction with half timber buildings, as in parts of Windsor Castle, for filling up between the studs, it gradually superseded timber construction, and by the time of Charles I. became the principal building material for the home and eastern counties. Its history in this regard has been rather curious. Throughout the reign of Henry VIII. brickwork was freely employed not only for plain building but also for ornamental work. Moulded panels, tracery, and cusping, were executed in brickwork and terra-cotta; but from the middle of the sixteenth to the middle of the seventeenth century its use for ornamental purposes seems to have been practically abandoned, and it does not seem to have occurred to English builders to employ it for moulded strings, pilasters, cornices, and other details, till the middle of the seventeenth century. Brick mullions, elliptical window heads, and labels are found in Elizabethan and Jacobean buildings, as, for instance, in the almshouses at Audley End, and moulded brick copings to gables are common; but ornamental details were nearly always executed in stonework throughout this period.

The development of design in brickwork is seen most clearly in the treatment of chimneys and gables. Throughout the eastern counties the corbie step gable was commonly used in the sixteenth century. Instances are found in Norfolk, Suffolk, and Essex. There is a gateway at Sandwich, dated, with a gable of this description, and another, now used as the entrance to a brewery, in St. Dunstan's Street, Canterbury. These are evidently inspired by Flemish examples, as is the characteristic bonding employed for the rake of plain gables in buildings of this date in the eastern counties. At the beginning of the seventeenth century the stepped gable seems to have been

gradually superseded by gables formed of segments of a circle, as, for instance, the gables of the river front of St. John's, Cambridge. These latter are frequently found in seventeenth-century houses in the Isle of Thanet, throughout east Kent, in Norfolk and Suffolk, and elsewhere in England, and may have been suggested by the stone gables of the Jacobean house, but it is more probable that they were suggested by the gables of the Netherlands. Mr. Gotch gives a characteristic example at Bourne Pond, near Colchester, dated 1591, which exactly resembles some of the gable ends of the north of Holland. Brick gables continued in use till the gable treatment was superseded by cornices of moulded brick, wood, or stone at the end of the seventeenth century.

Chimney-stacks did not come into common use before the time of Henry VIII. Of course chimneys are found in castles and in important buildings of a very much earlier date; but as late as the middle of the sixteenth century it was still the custom in many a yeoman's house to let the smoke of the hall escape through a louvre in the roof. The change can be followed closely in the half timber houses of the Weald of Kent. In these houses, built on a flat H plan, the centre was occupied by the common living room, open to the roof. About 1550 or thereabouts, for the date can only be arrived at approximately from an examination of the mouldings, a floor was inserted some seven to nine feet above the ground floor, and the hall converted into a ground and first floor, the old cambered tie-beams and octagonal king-posts still remaining above the first floor. There are examples of this to be found at Dixter, near Northiam in Sussex, Willesley at Cranbrook, and at houses in Headcorn, and Lamberhurst in Kent. At the time this conversion was carried out, the chimney-stack was built, and it usually consisted of an immense opening on the ground floor, varying in size from about 4 ft. by 8 ft. in smaller instances to 5 or 6 ft. by 14 ft. in larger, usually with one or more windows in the outer wall of the stack, and with a cambered oak beam to act as a lintel in the side of the room. This formed the ingle-nook. The owner sat inside it, and bacon and hams were smoked in the huge cavity above, which ran straight up, gradually diminishing till it reached the open air. The whole was admirably picturesque, but better adapted for down draughts and for smoking bacon than for the purposes of a chimney. The upper

part of the chimney-stack was either carried up square, or if, as was the case in houses of a better class, several flues were taken up together, the flues at the top were built as octagonal shafts, often enriched with moulded caps and bases, as at East Barsham and the older chimneys at Hampton Court, or the shafts were set diagonally on the rectangular base, as at Mapledurham. Probably to counteract the down draughts of this unscientific flue, these chimney-stacks were usually carried up to a considerable height above the roof. This form of chimney-stack continued in common use till the beginning of the seventeenth century. It was gradually found, however, that flues help each other by being brought into close contact, and that the great size of the older flues was unnecessary; and by the middle of the seventeenth century chimney-stacks had developed into the form which they have practically retained ever since, namely, a compact rectangular stack. The flue was made smaller, and the size of chimney openings was gradually reduced, till they dwindled down to the exiguous dimensions induced by the modern grate. Instead of detached or semi-detached octagonal shafts, the sides of the upper part of the flue, if ornamented at all, had moulded panels of rubbed brick, or a recessed panel with semicircular head and a simple moulded entablature at the top. There is a good simple example at Burwash in Sussex, dated 1699. In the following century, and after Wren's influence had been superseded by the fashion for rigid Palladianism, the chimney-stack was neglected. In fact, by the middle of the eighteenth century architects had ceased to consider the chimney-stack as an essential feature of the elevation. They dealt with it rather as a necessary evil, to be kept in the background as much as possible.

About the middle of the seventeenth century what is called "rubbed brickwork," that is, brickwork not cast as in terracotta, but rubbed to section, or carved for ornament, came into general use. Instances of simple architrave mouldings in rubbed brick are to be found at West Woodhay and Rainham. But before rubbed brickwork came into general use, the seventeenth-century builders had begun to feel their way towards a bolder use of ordinary brickwork. At Godalming in Surrey there are two houses which show a rudimentary attempt at decoration by panelling executed in ordinary brickwork with rubble filling-in. The later of these two houses is dated 1663.



L. Varney & Son, Buckingham, photo.

WOTTON HOUSE, AYLESBURY.

Pilasters and entablatures were now built frankly in brickwork, and probably one of the earliest examples is the house in Great Queen Street, Lincoln's Inn Fields, with brick pilasters and string courses, attributed to John Webb. Pocock's School, Rye, and a house in the High Street at Newbury (1669), are characteristic examples. The elevation of Pocock's School, which is entirely of brick, consists of pilasters in three bays, on very high pedestals, with a brick entablature and an attic storey above, with three dormers with brick pediments. The designer made no attempt to adhere exactly to the orthodox rules of the Tuscan order, the order which he followed approximately. He subordinated his order to the exigencies of his brickwork, that is, he designed all his mouldings with a view to their safe and easy execution in coarse-jointed brickwork, so that each course is securely bedded, and has a sufficient bearing in the wall. Yet the work is by no means ignorant. All the members of the order are there, in suggestion rather than in literal transcript, and, as in the case of a good many buildings of this date in England whose architect is unknown, this building was evidently the work of a strong and original designer, who thought for himself in the material which he employed. The arches over the windows are straight brick arches, channelled to form voussoirs and key-blocks. These are of rubbed brick, but coarsely jointed.

The use of fine rubbed brickwork with very thin joints seems to have been introduced by Wren early in the reign of Charles II., and was probably suggested by the Dutch noblemen who came over with William. There are examples of its use in the doorways of King's Bench Walk and in the entrance to the Middle Temple, in the Strand, where it is used for the wall surfaces; in the entrance to Christ's Hospital, next Christ Church, Newgate Street; in Kensington Palace, the Trinity House Almshouses, Emmanuel Hospital, since destroyed, and many other instances in the eastern and southern counties. Wren, in fact, did more to extend the use of brickwork, and to show how it ought to be treated, than any architect who has ever practised in England. Bishop's Hostel, Trinity, Cambridge, dated 1670, is an early example of Wren's use of brick and stone, before he had fully mastered his art. It is picturesque, but a little immature in detail. Such houses, however, as Groombridge in Kent, Tyttenhanger near St. Albans, Wotton

House near Aylesbury, and Wren's beautiful combination of gauged brick and Portland stone in many of his buildings are unrivalled in their sober dignity, and in what one may call a certain graciousness in design. The well-known example in West Street, Chichester, which is attributed to Wren, shows the complete perfection of this manner of design. Certain irregularities in detail show here and there the hand of the unskilful workman. Wren was probably too busily employed to give much personal attention to a comparatively unimportant building, such as this, but all his extraordinary felicity of design appears in its beautiful proportions and spacing, in the exact adjustment of materials, and, not least of all, in the insight shown into their colour relations. There are other instances of this kind of work in the Close at Salisbury and at Winchester, and, considering the number of examples which still remain in England, and their great beauty and reasonableness, it is curious that they should have hitherto received such scanty attention.

Two causes seem to have led to the gradual disuse of brickwork for important buildings. Pedantic Palladians, such as Campbell, thought it too mean a material for buildings in the grand manner. Certain deviations from the orthodox canons were involved in the use of brickwork, and they preferred a material such as Bath stone, which could be cut into any shape they pleased. On the other hand, the eighteenth-century amateurs of Gothic architecture, who considered that no building had caught the true mediæval manner unless it was prickly with pinnacles, found it cheaper to build sham castles in stucco and plaster. This position was further reinforced by the landscape gardener, who made the extraordinary discovery that red brick walls and chimneys looked very ill against foliage, and insisted that all old red brick buildings should be covered with stucco and painted white. This was, in fact, done to a great many red brick country houses; Heathfield in Sussex is an instance. After 1750 stucco architecture, to a great extent, superseded brick building, and the use of the latter was not really revived till about thirty years ago. Fortunately, houses in which no architect was employed continued to be built in excellent red brickwork till the end of the eighteenth century, and some very charming examples are to be found in the south of England, especially in Sussex, in which red brick and gray vitrified

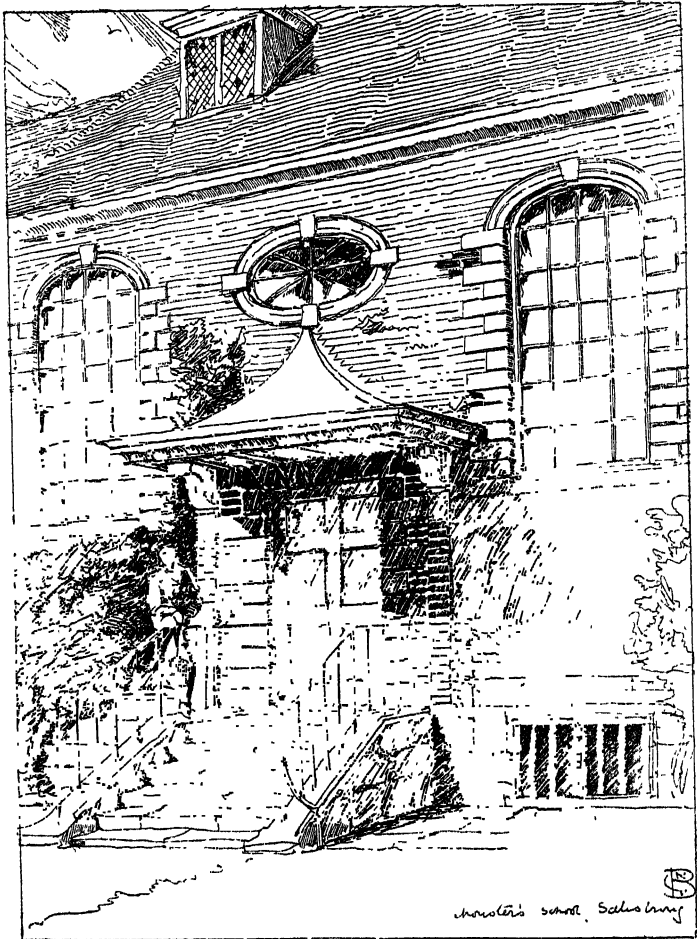

CHORISTERS' SCHOOL, SALISBURY.

“headers” are combined with excellent effect. The house at Arundel, illustrated in the text, is an instance, and there is a fine example in the High Street of Wallingford, in which the

dressings, arches, pilasters, and entablature are in red brick, and the wall face in gray. As usual, the old habits lingered on in country towns, and I have seen a house in Canterbury, built as

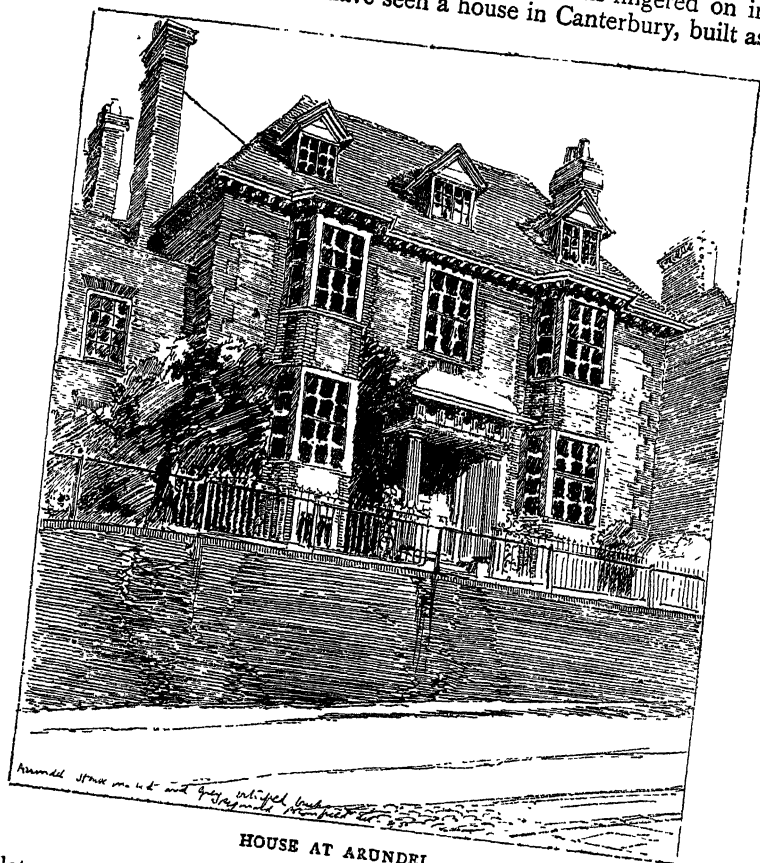

HOUSE AT ARUNDEL.

late as 1840, which, except for some heaviness of touch, follows closely the eighteenth-century manner. This, however, is an exceptional instance, and the kindly manner of domestic architecture inspired by Wren had long since disappeared.

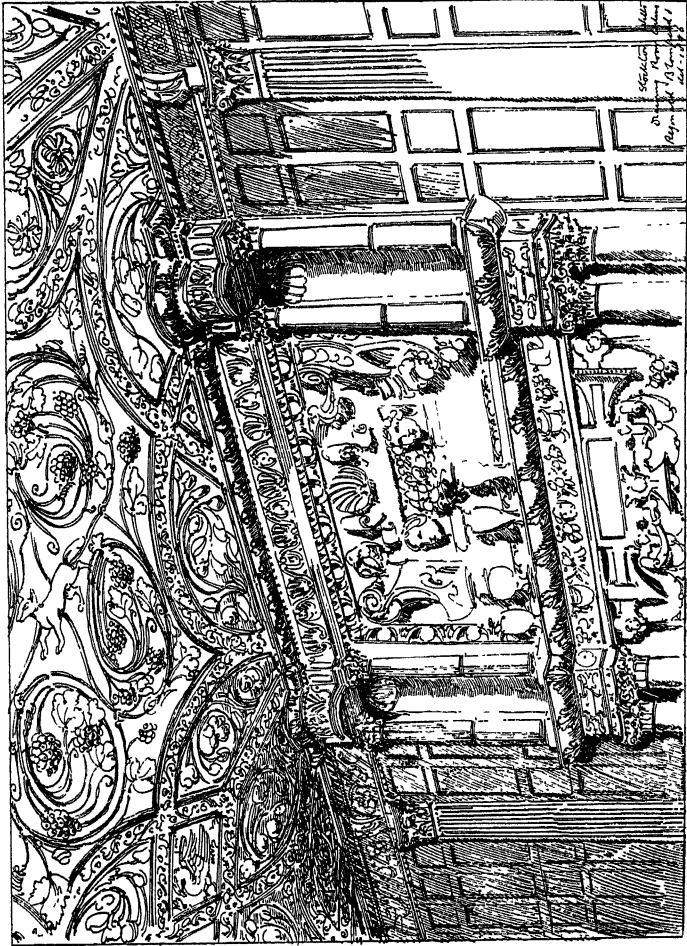

CEILING AT STOCKTON, WILTS.

It has been pointed out above that after the disappearance of terra-cotta in England no attempt was made to use brickwork for ornamental purposes till the middle of the seventeenth century. It is probable that the free use of decorative plaster work, introduced by the Italians, had a good deal to do with this. The soft red bricks (known as rubbers), so freely employed by Wren, were not yet invented, and where freestone for carving was not obtainable modelled plaster work provided a cheap and effective method of decoration. It is probable that the elaborate plaster work at Nonesuch, executed by Italians for Henry VIII., was the first revelation to English workmen of the possibilities of this homely material. Simple stamped patterns they had been used to, and pargetting, such, for instance, as the ceiling of Cobb's Hall, Aldington in Kent, which dates from the time of Henry VIII. But at Nonesuch for the first time they saw plaster work used with a freedom and mastery which suggested infinite possibilities of decoration; and it is certain that from this time forward plaster work took an entirely fresh start. How far the traditions of plaster work executed by Italian workmen in various parts of the country are founded on fact it is impossible to say in the absence of documentary evidence, but there can be little doubt that these traditions are very much exaggerated, and the majority of these ceilings, said to have been executed by Italian workmen, are clearly English work; the tradition may have arisen from their having been given out at the time as executed in the Italian manner. The work at Nonesuch has long since disappeared. The Duke of Saxe-Weimar, writing early in the seventeenth century, says, "The labours of Hercules were set forth on the king's side, the queen's side exhibiting all kinds of heathen stories with naked female figures." There remain at Hardwicke Hall, however, both in the old house and in the new, plaster friezes of great importance and singular beauty. The fragment in the rooms of the old house is 8 or 9 ft. high; the design appears to have consisted of stags on either side of a tree, with tall lilies or some field plant dividing the repeat; there are no remains of colour, and the highest relief is about 3 to 4 in. The great frieze in the presence chamber of the new house was probably executed by the same artist; this frieze is 11 ft. high; the relief is about the same, but it is coloured. The principal subject is Diana and her nymphs under great forest trees; stags, lions, elephants, and camels are introduced, with

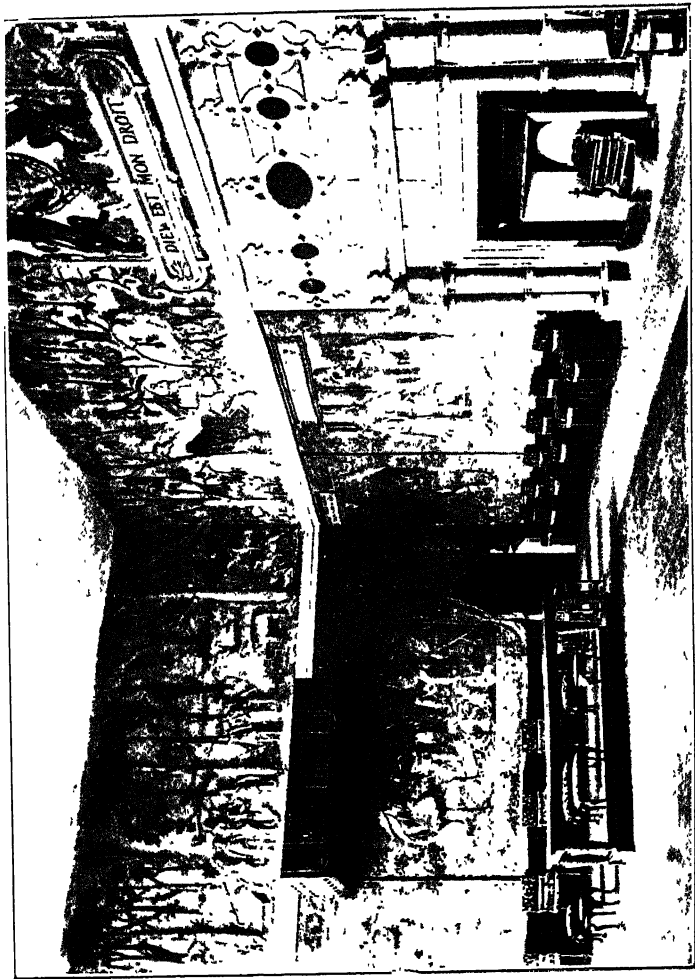

R. Keene, photo.

THE PRESENCE CHAMBER, HARDWICKE HALL, DERBYSHIRE.

the delightful recklessness of the early Renaissance, a recklessness, however, more apparent than real, for it was always controlled by an extremely subtle decorative sense; and in this frieze, though the details are isolated, yet the whole hangs together, and, helped by the delicate colouring, forms one of the most beautiful pieces of wall decoration to be found in this country. On the whole, this frieze is probably English work, but the man who did it had studied under Italians, and escaped the German influence which was superseding that fine tradition. Examples of this German motive are found in the cartouches over the mantelpieces at Hardwicke, and during the reign of Elizabeth it became exceedingly popular, driving out the very much finer work of the earlier men of the century, and being in its turn superseded by the design of Inigo Jones.

Two schools of design can in fact be traced in the abundance of plaster work which remains to us from the sixteenth century. The first, and, in my opinion, by far the most important, is the English school, that is, work executed by English workmen, and almost certainly designed by them, whether or not these men had originally learnt their craft from the Italians employed by Henry VIII. In this school I should include the friezes of Hardwicke, and that large class of ceilings which consist of moulded ribs, sometimes enriched with patterns, with free designs of animals and foliage in the intervening spaces; for the idea of this was essentially English and not Italian. The Italian idea of a ceiling was to coffer it deeply with elaborately moulded ribs; they actually left in England an example of this method in the ceiling of Bishop West's chapel at Ely. The intention of the English designer was different. He kept his rib low, and aimed at producing a rich continuous surface, adapted to diffusing light instead of holding it. The ceiling in the long gallery at Knole is a beautiful example of this, a broad, flat moulded rib, enriched with bunches of grapes, forms the pattern, carnations and other flowers are worked in low relief in the spaces, and a great deal of the plain ground is left to show. Other examples are found in the gallery at Haddon Hall, at Charlton, at Canons Ashby, and in the beautiful ceiling of the drawing-room at Stockton in Wiltshire. A remarkable instance exists at Great Yarmouth. In the Star Inn the ceiling of the old banqueting-room is covered with a pattern formed of a moulded rib, and some of the intermediate spaces are filled in

with a design of water-lilies, mallows, and other plants, modelled in very bold relief and with extraordinary vigour. In the Nelson room in this house is another ceiling of the same date, but comparatively commonplace design, and it seems that the ceiling of the banqueting-room is the individual work of a singularly able artist. Other examples by the same hand are to be found in Great Yarmouth.

Another variation of the purely English ceiling is the ceiling with simple moulded ribs, worked in geometrical designs with pendants at the intersections and foliations where the patterns run out on the ground. The hall at Littlecote has a good simple ceiling of this description, and there are characteristic examples at South Wraxhall, and in the withdrawing-room of Lytes-Cary, where shields with crests and Tudor roses are worked at the meeting of the ribs.

The second school of design in English plaster work of the sixteenth century resulted from the free employment of Dutch and German workmen in the reign of Elizabeth. The principal motive of this design consisted of variations of strap-work, such as the well-known examples at Blickling and Audley End, and a free use was made of cartouches as decorative panels. Much of this work is valuable as giving texture to the surface of the ceiling, but it is inferior in interest to the more purely English method, and lacked the individuality which gave to the latter its particular charm.

The use of plaster work was by no means confined to interiors. Henry VIII. had used it boldly for the outside of his palace Nonesuch. Owing, however, to its perishable nature, few examples of external plaster work on a large scale have survived. There is a fine example at Clare in Suffolk, and another at Wyvenhoe near Colchester, where the whole of one side of a house is covered with a bold design, apparently all worked by hand. At West Drayton there is a gable covered entirely with a design in strap-work. The eastern counties are peculiarly rich in external plaster work. Besides such well-known instances as Sparrow's House at Ipswich, there is still to be found in the Suffolk villages a great quantity of simple pattern-work decoration of the seventeenth century, probably executed by the village plasterer, and exceedingly good of its kind. Plaster work for external decoration continued in use till the end of the seventeenth century. There is a good example in

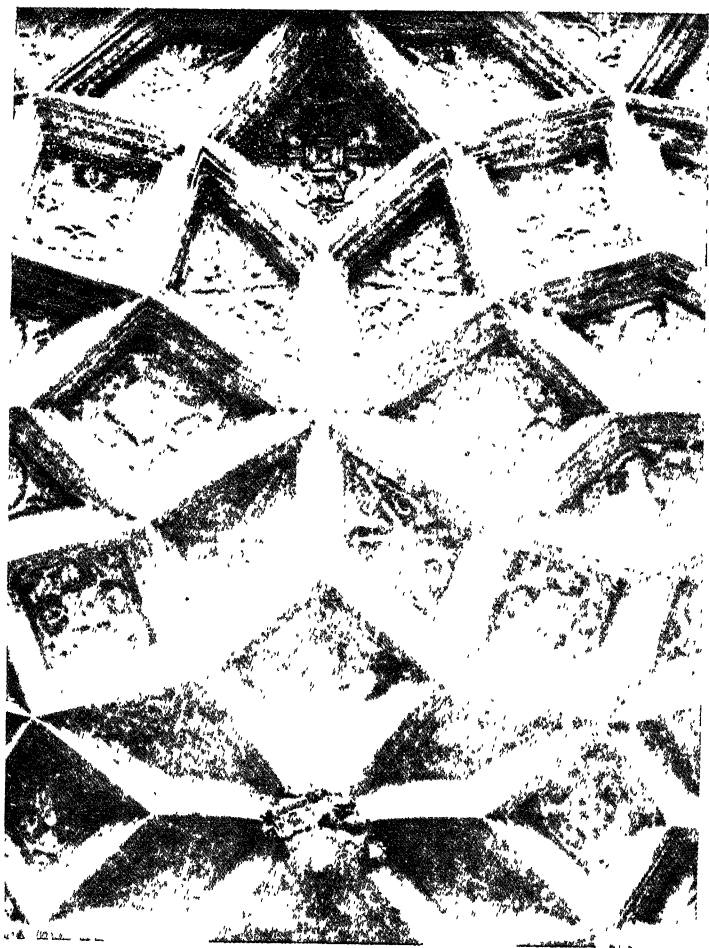

Frith & Co. photo.

p. 274.

THE CEILING OF BISHOP WEST'S CHAPEL, ELY CATHEDRAL.

Bank Street at Maidstone, and on the first floor of a house in the High Street at Canterbury there are figures of Bacchus seated on a cask, surrounded by vines. These date from about 1690, and one of the finest examples, the house opposite the Town Hall at Hertford, which is decorated with panels of bold acanthus scrolls, dates from the early part of the eighteenth century. Its use was abandoned at about this period, and wher.

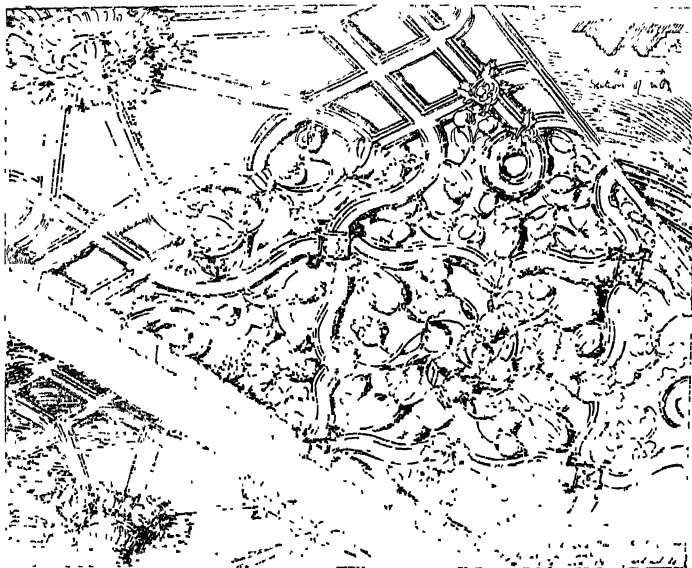

CEILING, STAR INN, GREAT YARMOUTH.

external plaster work was employed again, at the end of the century, it was on perfectly different lines. It was used as a cheap substitute for stone-work, pilasters and entablatures were made in stucco, and it is owing to this use of the material that plaster has fallen into a disrepute which it by no means deserves.

Meanwhile internal plaster work had undergone a very complete change. Inigo Jones had introduced a new manner from Italy, using moulded ribs of greatly increased dimen-

sions with panels of simpler design and very much greater size. There is a good early example at Ford Abbey. The plan of this ceiling is oblong, in the centre is a great oval with two oblong compartments at each end, and the ribs have flat soffits filled in with leaves bound with a fillet, the sides being enriched with egg-and-tongue mouldings and beadings. The ground in this example is filled up with free arabesques, but in his more mature work Inigo Jones left the groundwork free, and contented himself with masques, and boldly-designed swags of fruit and leaves for his friezes. The ceiling of the great saloon at Rainham is perhaps the most perfect example left of Inigo Jones's method of treating plaster. The room is of great height, and the detail of the ceiling is extremely bold. It is deeply coffered in compartments, and in the centre is an oval rib with modillions, heavily moulded, and a soffit enriched with fruit and flowers modelled in very high relief, but not undercut as in the later work of the seventeenth century. John Webb carried on this tradition, but his work is coarser and habitually inferior in execution; the ceiling of the dining-room at Thorpe Hall, fine as it is, shows clearly the falling off in delicacy of handling. Some of the plaster work, however, at Ashburnham House, is not inferior to the best work done under Inigo Jones himself, and the ceiling of the Church of St. Charles the Martyr at Tunbridge Wells (1682-90) shows that this tradition survived, though the fashion had already set in for the weaker and far less architectural methods of decoration borrowed by Wren from the architects of Louis Quatorze.

With Webb disappeared the last of the older tradition. Wren was still a young man with all his art to learn, and he rather unfortunately based his ornament on French models and the work then being carried on at the Louvre. The art of plaster work never recovered this disastrous impulse. The difference between Wren's technique and that of Inigo Jones is, that whereas Wren imported his detail wholesale and without any great reflection, Inigo Jones assimilated the motives that he borrowed from the Italian masters. His mind wrought upon them in such a way that, without losing their correctness in point of style, they became with him a personal and individual mode of expression, and not only that, but they became English in idiom and took their place in the line of English tradition. But Wren introduced the disastrous habit of taking detail on

trust ; with all his skill and genius as an architect, his ornament to the last was never quite free from a suspicion of the manner-

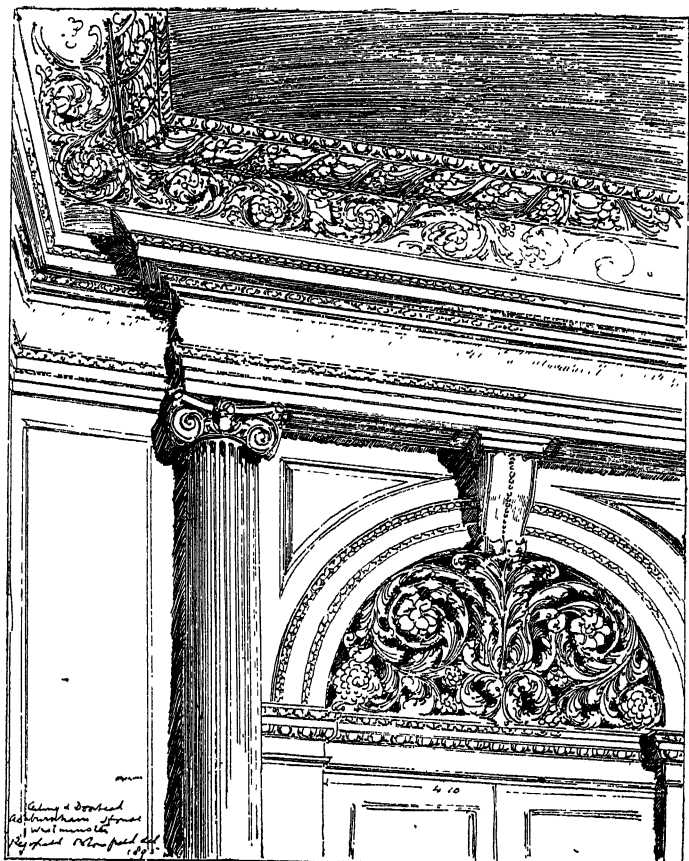

CORNICE AND DOORHEAD, ASHBURNHAM HOUSE.

isms of the amateur, and where Wren failed no one else was likely to succeed. Plaster work became more and more elaborate and more and more meaningless, and Wren was either too

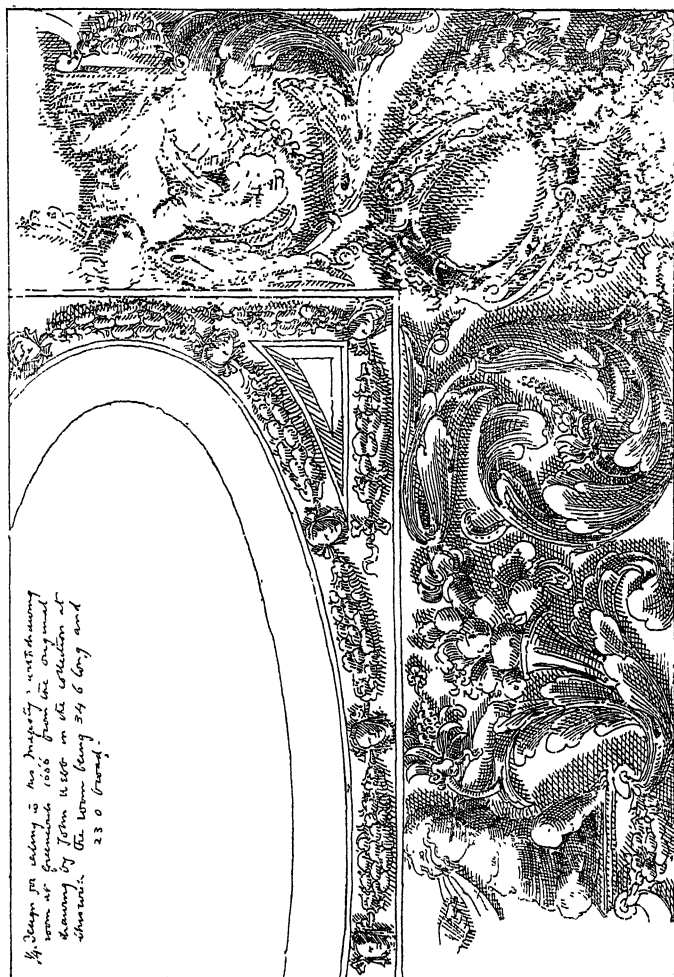

DESIGN FOR CEILING FOR HIS MAJESTY'S DRAWING-ROOM AT GREENWICH.
 (From a drawing at Chiswick by John Webb, 1666.)

busy or too indifferent to do anything to arrest this decadence. The ornamental plaster work with which he contented himself in the ceilings of his churches has only one merit, it is usually right in scale; but it is as a rule trivial in the last degree, and the tendency to over-elaboration was intensified by the astonishing cleverness of Grinling Gibbons. This dexterous carver delighted in *tours de force*, sprays of foliage hanging by a twig, birds and fruit and flowers, carved indeed to the life, but with-

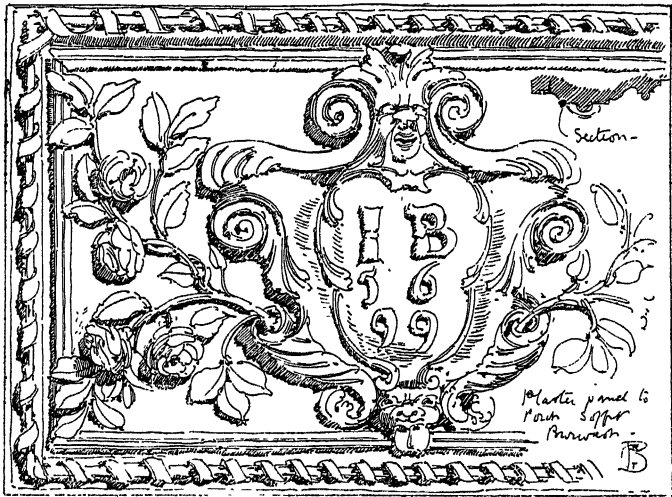

PANEL, BURWASH.

out the slightest regard to that selection and subordination which are necessary to good architectural ornament. Most of Gibbons's ceilings, such as that of the dining-room of Melton Constable, are believed to be carved in wood, but they were imitated as closely as possible in plaster with very unhappy results. The ceiling of the vestry of St. Lawrence Jewry is an instance. The carving here, which is very beautiful of its kind, was by Gibbons, and it is highly probable that he provided the ceiling as well. The exuberant design of rose and thistle above the east arch of St. Clement Danes shows some recollection of

the less conventional ornament of Jacobean times; and such instances as the little panel over the entrance to a house at Burwash show that something of this spirit survived till the end of the seventeenth century; but in London the professional architect was now an established person, and he was much more occupied with the niceties of Palladian design than with the details of craftsmanship. Instead of supplying designs for plaster work or carving he relegated the whole affair to the carver and plasterer, being perfectly satisfied that he would produce the accepted ornament of the time, neither more nor less. Gibbs refers with singular complacency to the fretwork "by Signori Artari and Bagutti, the best fret-workers that ever came into England," and the result of this confidence is seen in the deplorably vulgar plaster work to the ceiling of St. Martin-in-the-Fields. For the first half of the eighteenth century this rococo ornament continued in use, varied by the severely formal decoration allowed by the strict Palladians. Ware, in his "Complete Body of Architecture," was severe in his condemnation of the French, "who," he says, "have furnished us with abundance of fanciful decorations for these purposes, little less barbarous than the Gothic;" but Ware himself, though he designed ceilings on the lines laid down by Inigo Jones, allowed himself to borrow from the French, and some of his ceilings are scarcely less rococo than the work of Artari and Bagutti. Chambers confined himself to frets and guilloches and mechanical ornaments, or "when the utmost degree of richness in the decoration is aimed at, the ground of the compartment is likewise adorned either with paintings or with basso-relievo, representing grotesque figures, foliage, festoons, tripods, vases, and the like." The detail is correct but lifeless, and this remained the accepted method of decorating ceilings down to the middle of the present century. The only serious attempt at an original use of plaster work in the last century was made by Robert Adam, who brought back Pergolesi from Italy to do his plaster work, and obtained possession of the patent stucco invented by Liardet, and used it with great freedom both in the inside and outside of his buildings. Remains of the latter, in a very dilapidated state, may be seen on some of the houses in Fitzroy Square. Adam was very fond of filling in the tympana of arches with fan-shaped fluting, modelled in low relief. There is a good example of

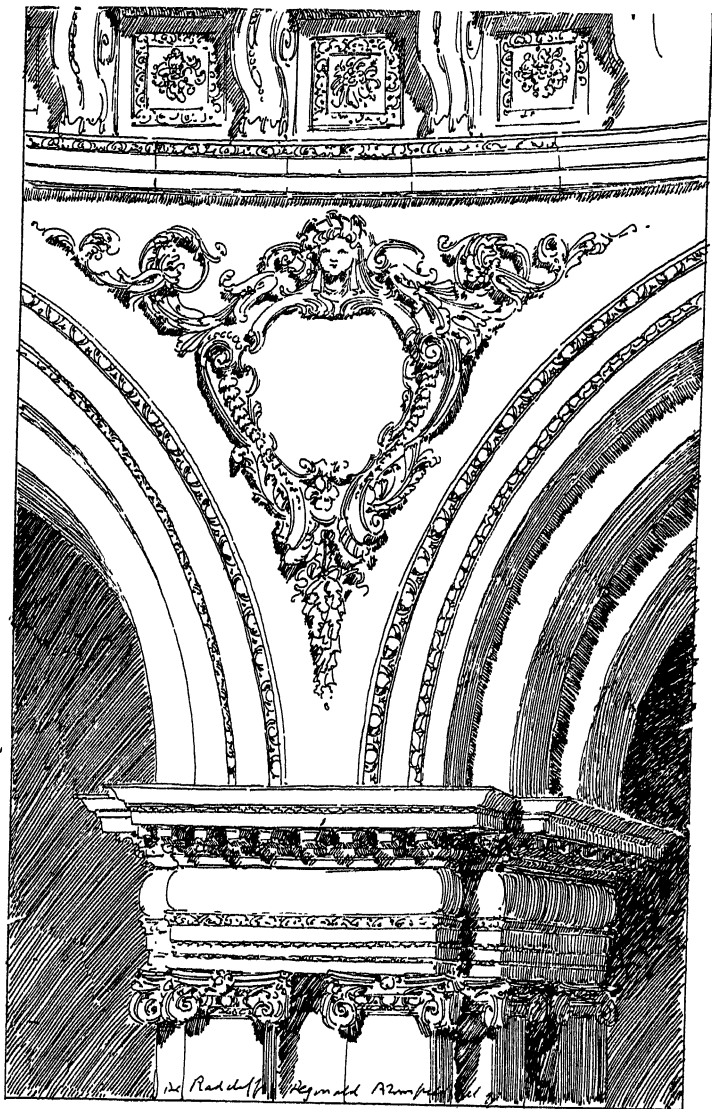

SPANDREL, RADCLIFFE LIBRARY, OXFORD.

this in the east side of St. James's Street. His manner of internal decoration is very well known, both from his published designs and the many instances still left in London and elsewhere. Adam's ornament is not exciting, but it is nearly always graceful and very well spaced, and there is no doubt that it was an improvement on the meaningless detail which it superseded. It is very slight in relief and thin in design, and, as originally executed, its effect was usually heightened by tinting the ground. At Kenwood the stucco work was carried out by Rose, and coloured by Zucchi, who tinted the ground pink and green, Adam says, "to take off the glare." There are good examples of Adam's plaster work in the state bedroom at Blickling Hall, at Audley End, and in the dining-room of Mellerstain near Kelso, all of which ceilings preserve the original colouring. Adam's method was freely imitated at the time, and designs in this manner can be found in most of the pattern-books published towards the end of the eighteenth century. A great quantity of work which is ascribed to Adam was not by him at all, but the work of comparatively unknown men who followed the fashion of the time, and employed this method of plaster work quite as skilfully as Adam or anyone else. Thomas and Charles Clark, Collins, Rose, and Joseph Papworth were all well-known plasterers in the latter part of the last century. After Adam's death plaster work as a means of artistic expression disappeared; the classical men relapsed into frets and guilloches, and the Gothic enthusiasts produced plaster cusps and crockets in great abundance. It is only within the last thirty years that any attempt has been made to use plaster work on legitimate lines, and to get out of it the quality of texture and surface decoration of which it is undoubtedly capable.

Leadwork is another of the crafts that has perished, partly through the callousness of the professional architect, partly through the demand that has grown up in the present century for the cheap reproduction in other materials of good and costly work. Cast iron has taken its place for rain-water heads and stack-pipes, cisterns and fountains, for all of which purposes lead was extensively used in the sixteenth, seventeenth, and eighteenth centuries. Lead was constantly used in the sixteenth century for enrichments to friezes and ceilings, for which purpose repeating patterns were cast in lead, applied to the ground,

and gilt or coloured. In Wolsey's closet at Hampton Court the ceiling is formed in octagonal panels, divided by moulded ribs in wood, with balls and leaves in lead at the intersections; these and the ornaments inside the panels are gilt on a bright blue ground. "The antyk and letters" on the roof of the

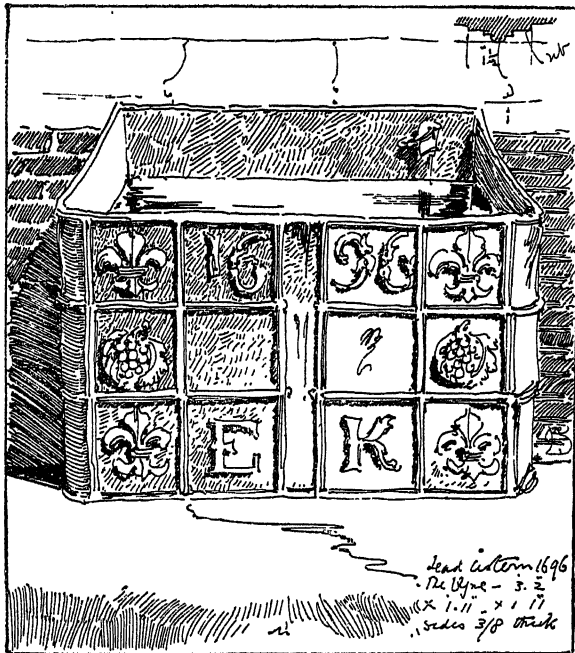

LEAD CISTERN AT THE VYNE, BASINGSTOKE.

chapel at Hampton Court were cast in lead and gilt, and the lead for this and other work at Hampton Court, carried out under Wolsey and Henry VIII., was bought from Master Babington in Derbyshire. In the accounts for the building of a banqueting house at Greenwich for the king, in 1527 (Brewer, Calendar of State Papers, iv. 2, 3104), occurs an entry: "Paid to John Wildeman, brazier of London, for moulds brought to

cast in lead at 6*z*. per lb., and repair of the same, named the broad leaf and the rose, the rose and the garnet, the leaf, the double ring, the double flower, the great pillar, the little flower, the 2 dolphins, the little pillar." In the same account appears an entry for "1700 little long leaves cast in lead." Lead was used for delicate applied ornaments in much the same way down to the end of the eighteenth century. Probably no instances of fountains in lead now exist. Frederic, Duke of Wurtemberg, who visited England about 1600, noticed that in the inner court of Windsor Castle there was "a curiously wrought fountain all of lead, several fathoms high." There were lead cisterns at Theobalds large enough to bathe in, and there still exists an octagonal tank at St. Fagan's Castle near Cardiff, 10 ft. across, dated 1620. Examples of these lead cisterns on a smaller scale are still found in England. At the Vyne, near Basingstoke, there is a rectangular tank, 3 ft. 2 in. by 1 ft. 11 in. by 1 ft. 11 in., the front of which is divided into square panels with a flat moulded rib; these panels contain fleur-de-lis and pomegranates alternately, the date 1696, and initials E. K. In the eighteenth century this panel decoration was developed with some elaboration. There is a good example at Sackville College, East Grinstead, dated 1750, and some are still to be seen in the areas of houses in Southampton Street and the squares of Bloomsbury. The example in the South Kensington Museum, dated 1732, is the finest that remains.

The changes of style are shown more clearly in rain-water heads than in any other form of lead work; the earliest examples are simple in shape. One of the earliest examples is a lead head at Hampton Court dated 1528, and another with the initials of Henry VIII. At the end of the sixteenth century the plumbers began to vary the shape by square, irregular, or circular projections, like little turrets engaged on the rectangular box that formed the head, as in the instance from St. John's, Cambridge, and these were further ornamented by bands and patterns of bright solder, as at Knole, or solder combined with painting, as at St. John's, Oxford, and the Bodleian, which date from the early part of the seventeenth century. The famous lead heads at Haddon, which are of about the same date, are decorated with pierced panels set against the inner casing. A small square rain-water head on Leominster Church, dated 1668, shows about the last of the older and simpler treatment

of lead for rain-water heads, and a marked change is evident towards the latter part of the seventeenth century. The plumber was now a very dexterous workman, and was ambitious of showing his skill in more recondite forms. Elaborate moulded work was introduced, acanthus leaves and monograms, and all sorts of devices were worked and applied with great freedom. The example from Shrewsbury (1730), and the clumsy head at Melbourn, dated 1744, illustrate the change that was destroying English craftsmanship. The workman had long since passed

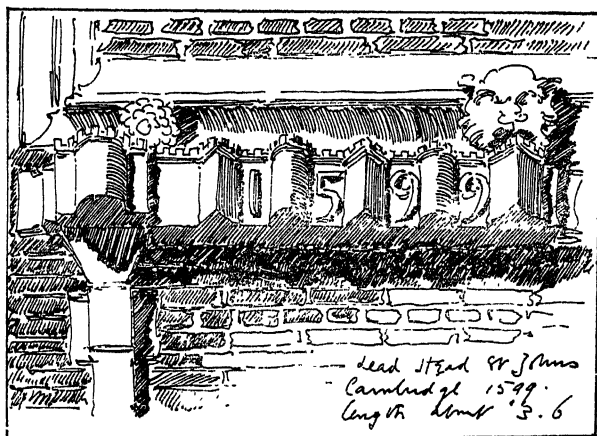

RAIN-WATER HEAD, ST. JOHN'S COLLEGE, CAMBRIDGE.

the limitations imposed by technical inexperience, and could not resist the temptation to sacrifice his material and ignore the purpose of his work, if only he could turn out a masterpiece of mechanical skill. He was, indeed, an accomplished tradesman in the old-fashioned sense of the word, but he had ceased to be an artist.

Lead urns and lead figures for gardens and gateways used to exist in abundance in England. In the inventory of goods at Hampton Court, taken in 1659, "four large flower-pots of lead" are mentioned, but it is doubtful if the beautiful vases now in the gardens are the urns referred to. The best examples

of these lead vases are to be found at Penshurst, at Melbourne in Derbyshire, and at Parham in Sussex. They used to be common enough in the older English gardens, but most of

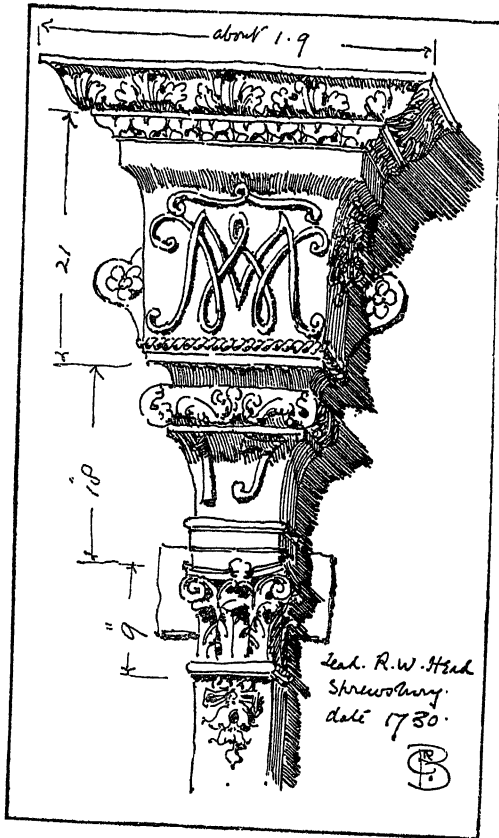

RAIN-WATER HEAD, SHREWSBURY.

them have disappeared in recent years, and but few examples are left, either of these or of the lead figures which were cast in great numbers in the eighteenth century. In the Fellows'

garden of Trinity Hall there were four lead figures of Learning, Cybele, Liberty, and Justice, each figure 5 ft. 9 in. high, standing on pedestals 3 ft. 6 in.; these were given by Sir Nathaniel Lloyd in 1722, at a cost of £79. The fine lead figures of Actæon and Artemis still stand on the great brick piers at Carshalton Park; there are

several in the gardens at Melbourne, and four at Hardwicke in Derbyshire set in niches of yew. The greater number of these figures were probably turned out at the famous lead yard in Piccadilly, established by a certain John Van Nost, a Dutchman who came over with William III., and whose business was sold in 1711. It was afterwards carried on by John Cheere, brother of Sir Henry Cheere the sculptor. Four other lead figure yards existed in Piccadilly in the middle of the eighteenth century, and Cheere's yard was not finally closed till his death in 1787. The lead figures and the lead urns went the way of the Formal Garden; they were swept away by false sentiment

and pedantic taste. The amateurs condemned them as wanting in the refinement of a purer art, and the landscape gardener could find no place for them in his amazing schemes, and with them disappeared the last touch of fancy in English handicraft.

The history of ironwork in England since the days of mediæval

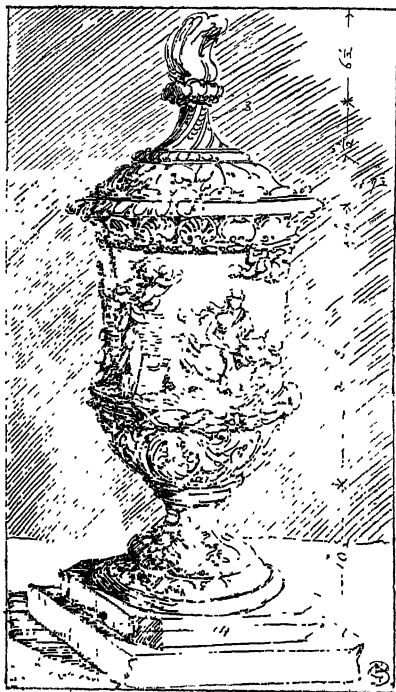

LEAD URN, PARHAM.

art is rather curious in that the smith's art appears to have been revolutionized almost entirely by one man. Throughout the sixteenth, and first half of the seventeenth century, the English smith was content with simple and unambitious work. The grille round Henry VII.'s tomb at Westminster seems to have

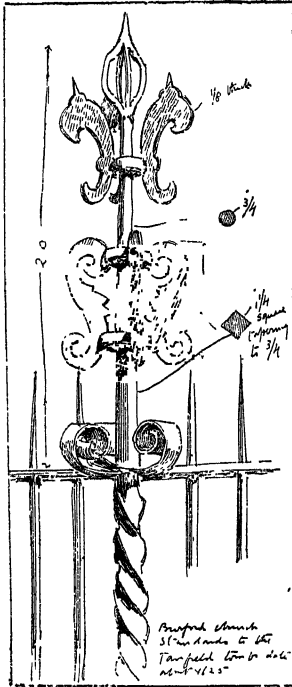

IRON STANDARD, BURFORD CHURCH.

been the last effort of the mediæval iron-worker. The very remarkable wrought iron gates to West's chapel at Ely are probably later, but they are not English work, and are almost certainly Flemish. English smiths, from the time of Elizabeth till the Restoration, do not seem to have been capable of anything but the most simple grilles, composed of plain or twisted bars with some rudimentary crestings and ornaments to the angle standards. At Currey Rivell in Somersetshire there is a characteristic example, which incloses a monument, dated 1593. The finial to the rails round the Walter monument in Ludlow Church, dated 1592, shows another not less primitive method of ornament. The chancel gates to Newbury Church are an instance of ordinary English seventeenth-century ironwork. The gates are formed of alternate square bars, $\frac{5}{8}$ in. thick, set diagonally, and of rough twisted bars measuring $\frac{3}{4}$ in. Every fourth upright has a pointed

head, and between these are crestings of pierced sheet iron $\frac{1}{8}$ in. thick. The crestings of the standards of the grille round the Tanfield monument in Burford Church, Oxfordshire, date about 1625, are formed in much the same way, out of cut sheet iron, $\frac{1}{8}$ in. thick, set four way round the standard, but the shaft of the latter is ingeniously opened out at the head and forged together again into a point. Iron-

work of this simple character continued in common use till the Restoration, and, in fact, survived till the end of the seventeenth century. The ironwork of the balcony, and the rods to the clock of Guildford Town Hall (1683), show no trace of Tijou's influence, and examples in the ironwork to the signs of country inns carry on the old tradition into the eighteenth century. Such ironwork as remains in buildings designed by Inigo Jones, or under his immediate influence, shows no attempt at any fresh departure from this traditional English method. The only

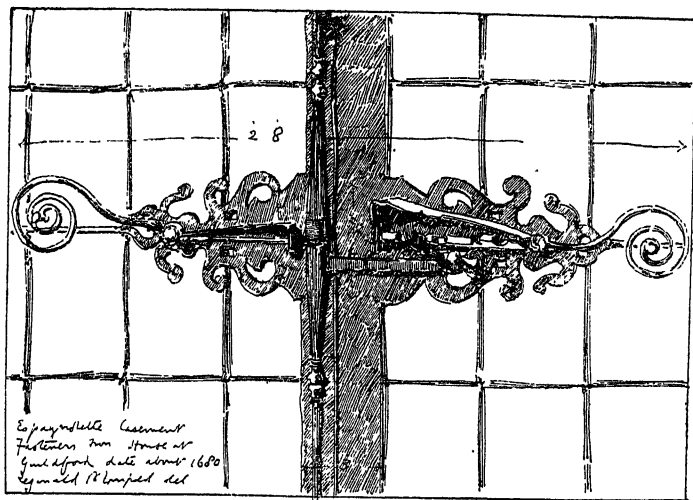

CASEMENT FASTENER, GUILDFORD.

variations that occur are in such minor details as 'scutcheons, door handles, and casement fasteners, some of which are elaborate in design and of very excellent workmanship. Those illustrated in the text exist in a late seventeenth-century house at Guildford.

The man who entirely altered the character of wrought iron work in England was Jean Tijou, a Frenchman, who came to England soon after the Restoration, possibly at Wren's suggestion. It appears that Tijou was employed at Hampton Court as early as 1670. When Wren began his designs for rebuilding



DETAIL OF GATES, ALL SOULS' COLLEGE, OXFORD.

the Palace in 1689 Tijou was again employed, and between 1689 and 1693 executed the magnificent series of gates and screens which used to ornament the gardens of Hampton Court. These gates are, on the whole, the finest specimens of wrought iron work to be found in England. They were at one time attributed to an Englishman, Huntingdon Shaw of Nottingham, on the strength of an inscription in Hampton Church. It has been ascertained that the words in the inscription in question were added in 1833, and though there is evidence that Shaw assisted Tijou in his work both at Hampton Court and St. Paul's, there is no doubt that the design of all this work was by Tijou, and that the great development in English ironwork which appeared towards the end of the seventeenth century was due to his extraordinary skill. Tijou also executed ironwork at Chatsworth for Talman, and at Burleigh, and it has been suggested that he designed the gates of the Clarendon Press at Oxford. (The beautiful ironwork at All Souls' seems rather later.) The latest entry in regard to Tijou occurs in the accounts of St. Paul's in 1711. The book of his

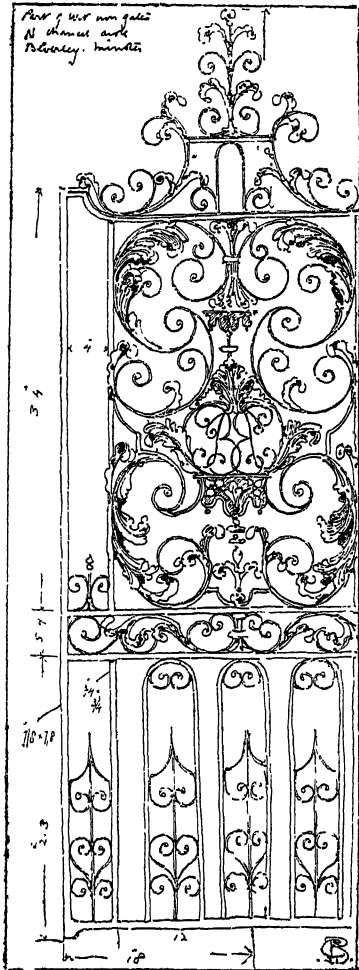

PART OF GATES, NORTH CHOIR AISLE, BEVERLEY MINSTER.

Paul's in 1711. The book of his

published designs, though of very great interest, gives an utterly erroneous impression of his executed work. Many of the designs shown are too florid and elaborate for their purpose, and a certain clumsiness of line, from which Tijou's actual work was completely free, was possibly due to the inadequate version of the engravers.

Throughout the first half of the eighteenth century the manner introduced by Tijou continued in use. Wrought iron unfortunately does not stand exposure so well as cast, and the life of this wrought iron work in England, unless very carefully watched and repaired, does not appear to be more than some 200 years ; but there still remain a great number of examples of this beautiful art in almost every part of England, and particularly in the neighbourhood of London. The Chiswick gates, now set in front of Devonshire House, are a particularly fine example, and the gates and railings at Carshalton Park are of about the same date. Another variation is illustrated in the gates to the close at Sherborne, which date from about the middle of the eighteenth century, and show a somewhat different motive in design, other examples of which are to be found in a gate to St. Peter's, Covent Garden, and at Queen's, Cambridge.

Towards the end of the eighteenth century the art rapidly degenerated, riveting took the place of welding, the designs were meagre and insignificant, and cast iron gradually superseded wrought. The art lingered on till the beginning of the present century in the country. At King's Lynn, for instance, there appears to have been a smith who followed the older fashion as late as 1803. But in this as in the other handicrafts the record of the nineteenth century has been disastrous. It has stifled the fine tradition of English craftsmanship, and its repeated experiments in the various arts have ended with depressing regularity in a *cul-de-sac*.

CHAPTER XV

CONCLUSION

IN a certain sense dates and periods in architecture are arbitrary, for ideas in art do not die, and long after the fashion has shifted, artists will appear, born out of date as it were, who revert to older methods and give a semblance of vitality to traditions that are almost dead. It is impossible to assign any definite date as the end of that new departure in English art which began in the reign of Henry VIII. Broadly speaking, however, the initial impetus of the Italian Renaissance had run itself out in England by the end of the eighteenth century. From first to last it had formed the predominating influence in English architecture for some 300 years, yet with many variations and vicissitudes. Both in its development and decay it moved slowly, and in its later history changed by such imperceptible degrees that the extent of its downward course is scarcely realized till one has reached the end. Fully one hundred years were taken up in experiment, for the Renaissance did not spring into full existence in England in the sixteenth century. It was at first an exotic, imported by those more highly educated Englishmen who first appreciated the Italian humanists, men who travelled in Italy not to study its art, but its letters. In its first introduction it was an affair of scholarship, and to some extent of accident. The natural consequence of this condition of affairs was that the first attempts at the Italian manner made in this country savoured of the amateur rather than of the fully trained artist. They were tentative, realized in details, in sculpture and decoration rather than in architecture. As has been already pointed out, the work that the Italians did for Wolsey and Henry VIII. at Hampton Court was practically confined to sculpture, modelling, and painting. The fact that it was limited

to ornament shows that for many years the movement was literary rather than artistic, an incident in the revival of letters rather than anything approaching the great artistic effort which formed at least half of the Italian Renaissance itself. So late an example as Shaw House (1581) illustrates clearly this aspect of it; the architecture is that of an ordinary Elizabethan house, but about the building are Italian details of unusual excellence, and over the door there is an inscription in Greek, *φθονερός μηδείας εἰσιτῶ*, evidently the personal fancy of a somewhat pedantic owner. The Renaissance in England was, in fact, for the first half of the sixteenth century, practically a court affair, and by no means commended itself to the English people in general. Evidence of this exists in contemporary writers, but the strongest evidence is found in the persistent retention of mediæval methods of domestic building long after Renaissance ornament was freely admitted in details. The consequence was that through the sixteenth century in England the expression of the new movement was tentative and uncertain, and the only explanation of its constant change is to be found in English politics of the time. Henry's break with Rome brought the first essay in Italian art to a close which is startling in its abruptness. The Italians returned to their own country or to France, and when Elizabeth ascended the throne the last of them, with unimportant exceptions, had left our shores. England was now a Protestant country, and Flemings and Germans found in it a refuge from persecution in their own countries, and, in the uncertain taste of the time, and the passion for building which few Elizabethan noblemen escaped, constant employment for their ingenuity and mechanical skill. These men were not artists but extremely dexterous workmen. They had little of the subtle instinct of the Italian, that quality which placed the work of the latter beyond the reach of mere industrious effort; and it was for this reason that the English craftsman very soon got abreast of the Germans and eventually drove them from the field. The influence of the Germans gradually declined, and the closing of the Steelyard at the end of the sixteenth century pretty well coincides with the date of the recovered ascendancy of the Englishman.

He was still, however, far below the Italian ideal of an artist. He had learnt to build and to carve, but his design was worse than ever. He depended on pattern-books. He had lost the

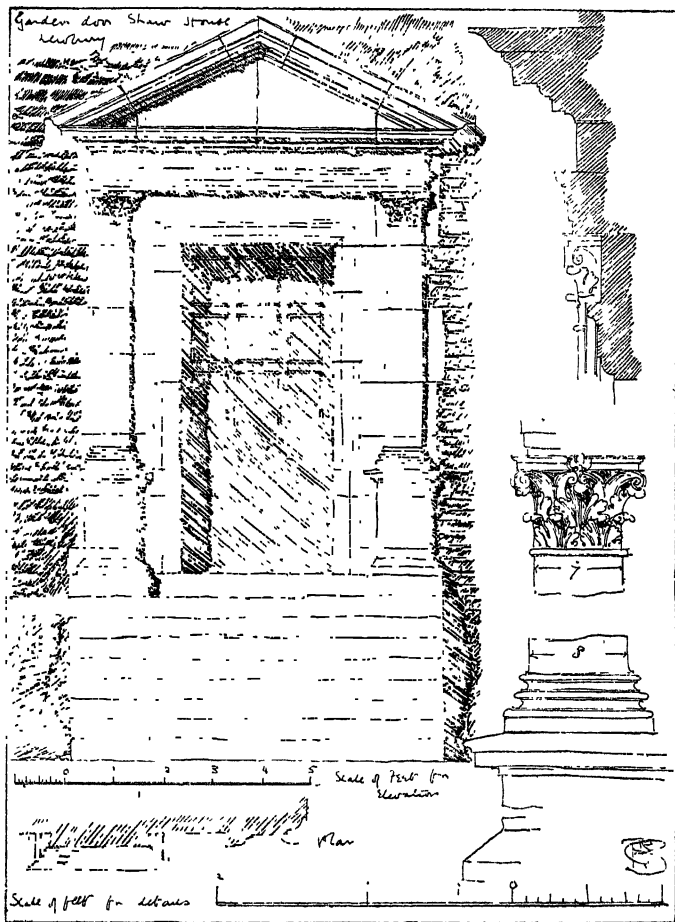

GARDEN DOOR, SHAW HOUSE, NEWBURY.

spontaneous vivacity of the late mediæval craftsman, and had thoroughly bewildered himself with the five orders. By the beginning of the seventeenth century he had reached a degree

of mechanical accomplishment and artistic uncertainty to which the art of the latter part of the nineteenth century affords a very close parallel. These men were like an army without leaders. The co-operative art of the Middle Ages was no longer possible, some one must take the lead. A strong individual intelligence was needed to restore order in this chaos of eclecticism, and to compel these scattered elements back into the path of ordered and logical art. At the right moment, when the workman-designer had come to a standstill, a genius of this order appeared in Inigo Jones. Comparatively little is really known of this great artist; only rare glimpses of a masterful personality can be caught from the scanty remains of his work, yet his figure looms large in the background of English art, for he was, in fact, the founder of modern architecture in England. Collective architecture, that is, architecture designed and executed by groups of men, was only practicable so long as there was no possibility of building in any but a single traditional style, well defined and well understood. As soon as other methods of design became possible and entered into consciousness, selection had to be made, and with this of necessity came in individual choice and individual control. In architecture the work of the Renaissance was to substitute the individual artist for groups of artists; whether this was desirable or not is hardly worth considering; it was the inevitable result of a change in the conditions of social life, and it was the essential service which Inigo Jones rendered the art of this country, that he cleared away the confusion in which English artists were losing their way, and taught them to recognize the fact that under modern conditions as opposed to mediæval, architecture must be an individual affair; and further, that architecture is an art with its own limits and ideals, not dependent on sculpture and painting as the later mediævalist had made it, but complete within itself and capable of realizing its full effect by simple qualities of line, mass, and proportion. It is this which differentiates the work of Inigo Jones from that of the Jacobean or Elizabethan designers, and gives it its supreme importance. He stamped English art with something of his own distinction, and gave it an impetus not entirely extinct even at the present day.

The break between Inigo Jones and Wren is inconsiderable. The civil wars brought about a temporary check, but Wren's

lucid intelligence very soon found the way back to the lines laid down by Inigo Jones. The modifications Wren introduced were mainly a matter of temperament. His easy tolerance admitted a certain licentiousness of detail which would hardly have satisfied the severer taste of his predecessor. Yet Wren was thoroughly English, and, in his happy compromise, exactly hit the English temperament; for though the eighteenth-century architects repudiated his authority, it is evident that Wren's manner was understood and appreciated by the English people, and it was this, and not the Palladianism affected by Lord Burlington's clique, that became the vernacular architecture of the country. The fifty years from the Restoration to the death of Queen Anne were, in fact, the culminating point of modern English architecture. Both architects and workmen thoroughly understood the technique of the style in which they were working, and, till the beginning of the eighteenth century, there was little of that fatal severance between architecture and building which was destined in another hundred years to bring about the degradation of both. Yet even before Wren died the disease had begun, and the fault lay with the architects. Their vanity led them to magnify architecture into a fine art and a mystery, and their cupidity to hand over its control to the ignorance of wealthy amateurs. As for the builder, they left him out of account, and the poor man had to make the best he could of designs made without regard to materials or climate, and which were, in fact, little more than academical exercises. Many of these designs were extremely fine in themselves, and several of the eighteenth-century architects were very able men; but an art such as architecture, based on the actual facts of existence, cannot afford to be insane. When once the clue of use and reasonableness was abandoned, no further limit to architectural experiment existed. If Italian villas could be imported wholesale, so also might mediæval castles or Greek temples; and in this way the great tradition of English art was lost, and the history of the hundred years from 1770 onwards has been nothing but a series of experiments in different styles, less interesting than those of the sixteenth century, because more artificial and insincere.

Yet, if English architecture is considered from its first beginnings, and compared in its general tendency with the art of other countries, it is possible to trace a permanent element

throughout its manifold changes, a definite bent towards certain qualities in design. Anyone who studies the history of architecture must feel that, behind all the classifications and artistic genealogies which are prepared for us, there lurks an elemental force which defies exact analysis and classification. It is fluid, constantly changing its form, yet always there, always impressing us with the notion that this, if one could only get at it, would be the clue by which to find our way through these bewildering changes of technique. It is no affair of details. These are no more than the words and the syntax of architecture; architecture itself is something very much greater, something beyond and outside all this. There is at the back of this technique an intelligence which informs and vitalizes it; an idiosyncrasy which colours it with its own individuality; some deep-set quality which differentiates the architecture of one country from that of another; and without which, indeed, architecture would be a mere plaything and fashion, unworthy of study, something apart from the serious stream of human development.

In individual work the key to a work of art is the man himself, his habits, his whole way of regarding life. To fathom the meaning of a picture of Leonardo one has to recall the dreamer and the poet—the intellectual exquisite, the man of extreme physical beauty; the austerity of Inigo Jones's architecture is better understood, when one realizes the stiff unbending nature of the man, that proud, perhaps arrogant temper which earned the undying hatred of Ben Jonson; so, too, with Wren, his easy, kindly nature is written in his work. The relation of the art of a great people to their national character is not less intimate. For the individuality of race is stronger than that of genius, and the art of the English people can only be interpreted by the past history and character of the English people themselves. Behind their art there stands the permanent human equation, the point of view from which they regard existence, their method of life and the ideals at which they aim. In other words, it is necessary to form some idea of their constitutional habit of mind, and to grasp the psychological standpoint of the race: so much so, indeed, that it is doubtful if any foreigner can quite understand the art of an alien people. In an old civilization this standpoint is intensified by the mere lapse of time, and one has to take into account the effect of

the long-continued maintenance of the same point of view acting and reacting on inherited ideas of what is reasonable and beautiful. The son profits by the experience of the father, and in this way there accumulates a large reserve of artistic knowledge and insight—in other words, a tradition of taste, which increases till the tide turns, and the stream runs itself out into the quicksands of copyism.

From this point of view, then, one may define tradition as an inherited psychological standpoint in regard to art. Under different forms and varying expressions the same tendencies repeat themselves in generation after generation, so that a continuous line of thought at length discloses itself in the history of our art. Certain instinctive preferences develop into a subtle and permanent influence always at work upon the art of the country, and it is only in a long survey of its history that this local colour is clearly seen. Even in the rude beginnings of our architecture certain tendencies are evident, which, with every generation, gained in force and staying power. In England, as in other countries of Europe, architecture (as apart from ornament) began with the heritage of the Romans, a heritage ill understood by those who came into it, yet the starting-point from which modern architecture was to grow. Now from the very first the difference of race asserted itself. When the Normans conquered England they brought with them their own accomplished version of round arched architecture to supersede the cruder art of the Saxon. Yet it was the latter race who in the long run gave to English art its peculiar bias. Norman architecture, at any rate, in common with the Romanesque of other countries, derived its descent from the round arch of the Romans; but the branches of this family soon separated so widely that one can barely recognize their kinship. Contrast, for instance, the archway of Iffley, or the mighty pillars of Durham, with the porticoes of Lombardy and the south of France. In both there is the barbaric love of ornament, the indomitable savagery of a half-civilized people; but here, in England, its expression is more primitive, something of the vigorous open-air energy of the northern peoples seems to have stamped itself on their work—the simplicity of taste and directness of purpose of a race who spent the best part of their existence in fighting by land and sea. One finds in it, if one may so put it, a certain sportsmanlike contempt for any-

thing trivial or irrelevant. But turn to such work as the west front of St. Gilles, or the gateway of St. Trophimus at Arles, and it is evident that the sculptor who carved these grim figures, and the savage beasts beneath them, must have looked at life from a different standpoint. In his veins still lingered the blood of the men who had found their pleasure in the tortures of the amphitheatre ; his work is burning with the passion of the South. It is instinct with the morbid energy of the Latin race.

Thus early began in England the promise of that sober dignity which was to be the essential characteristic of our later art. The artistic reticence, the even sanity of thought, which are traceable in the first beginnings of English architecture, continued to be its keynote, as one may say, throughout all its subsequent history. Contrast again Salisbury and Notre Dame, the austere asceticism of line in the first with the perfect sculpture of the latter. Always in the Frenchman one finds a certain expansiveness, an irresistible impulse to let himself go ; and in the Englishman, at his best, a certain self-repression, a strong determination to keep his thought and its expression well in hand. The consummate technical skill of the French architect and sculptor enabled them to produce in their great cathedrals absolute masterpieces of form and workmanship, so that in their unrivalled attainment they stand on the level of the earlier Greeks ; but the Englishman was after different ideals. His nature was possibly deeper, at least more self-contained ; he seemed to care less about attracting attention, more about expressing himself in his own characteristic way. The playfulness, the kindly humour, at least, so one imagines it, of the Saxons, asserted itself in the long run, weaving delicate fancies as it attained its full maturity, expressing itself in the exquisite imagery of the Chapter House of Ely, or the rich carving of Somerset, or in the admirable woodwork and colour of the churches of the eastern counties. In all of these one recognizes a quality peculiarly English, something familiar to us now, in spite of all that has gone between, a message in our own language from the far-distant past which we can understand to this day. One may admire the mediæval architecture of France and Spain, yet an Englishman cannot get into touch with it, as he can with the architecture of his own country ; and the reason why he can still understand the latter is that the character of the race has not changed fundamentally, and that the old

tradition still remains, though it has been dormant in England for these last hundred years.

Throughout the successive periods of English Gothic, the continuity of this tradition is unquestioned. It has been urged, however, that when the Renaissance came all this was changed, that the old tradition died, that the Renaissance came like the old man of the sea, sprang on the back of a beautiful art and strangled it; and, as the logical conclusion from this, that the history of English architecture ceases with the disappearance of Gothic. This view, I think, is neither sound philosophy nor honest history. It could hardly be urged by any but the most bigoted partisan that King's College Chapel shows any falling off, in vigour of design and execution, from the old tradition. King's College Chapel was begun early in the sixteenth century, almost in the very year in which Torrigiano came to England, and it has been represented as the last effort of the old tradition. In a sense it is, if by tradition is merely intended technical tradition; but if tradition is taken in that larger sense which I have endeavoured to give to it, how is it possible to conceive that a spirit which was still capable of such a magnificent effort, and which was deep-set in a race so conservative as the English, should suddenly disappear? It is not possible to imagine such a catastrophe, nor did any such abrupt lacuna in the chain of tradition ever actually happen. So engrained was the older feeling that, long after the technique of Renaissance architecture had established itself in England, the older methods of expression lingered on, cadences, as it were, too beautiful to be readily forgotten.

This, however, was no more than a survival of detail; the point is, that after the forms and methods of mediæval architecture had died out, there yet survived this permanent element of English tradition, an element outside all changes of style, and I cannot illustrate this more clearly than by the work of Inigo Jones himself. Inigo Jones was absolutely steeped in Palladianism. He had studied profoundly the works of Palladio in Italy, comparing and noting the actual remains of Roman architecture, assimilating all that the great Italian masters had taught and practised. He returned to England, probably, so far as he was conscious of it, resolved to introduce Palladianism pure and simple into his own country; but so masterful a genius is seldom conscious of its full intention. There were forces

within him and around him stronger than he could be aware of. He could not escape the tradition of his country, and his work, in its masculine austerity, is as truly English as the massive walls of Tewkesbury. The Banqueting House, for instance, is a deliberate design in the manner of Italian Renaissance architecture ; so, too, are certain of the London clubs, built in direct imitation of well-known Italian palaces. But whereas the latter are copies of a foreign building, the Banqueting House is unmistakably English, the work of a man who had absorbed into his own intelligence all that he had to learn from the art of another country, and who, by force of his own understanding and the tradition of his race, was able to make that art his own. It may be thought, indeed, that the extent of a man's genius as an artist is shown not least of all by his capacity for absorbing and assimilating tradition. It is this which enables him to give to his work that mysterious quality of style which can be felt but never defined—without which, indeed, no work, however able and at first sight impressive, is ever likely to retain its place in the permanent recognition of mankind. It is this capacity which enables him to reach the abiding element which outlasts all fashion, to touch the bottom rock of tradition—to return to the instincts of his race, those deep-seated likes and dislikes which no individual genius can defy.

In the history of architecture it is precisely in those men who have far outdistanced their contemporaries in permanent reputation that one finds the traditional sense most strongly developed. Wren was the most English of all English architects. He went to see Bernini in France, and talked with Mansard and Perrault, yet their influence on him was merely superficial. It spoilt his ornament, but left his faculty of design untouched. And in his later work, when he knew himself and was more completely master of his own language, he tended more and more to what we may call a purely English idiom in architecture. He consolidated the English tradition so surely that, for nearly a hundred years after his death, his example was adhered to in what has been called vernacular architecture, in spite of all the academical pedantries of Campbell, Kent, Lord Burlington, and other gentlemen of taste and fashion. Even Vanbrugh's architecture, huge, enormous, and unwieldy, if it was not English, was certainly nothing else ; and the best of the eighteenth-century architects— Hawksmoor, Gibbs, Ware, and

Sir William Chambers—followed the old school, and adhered, though with ever-failing fidelity, to the old tradition. Their work was at least “solid, masculine, and unaffected”—those memorable words of Inigo Jones, which epitomize the best traditions of English art.

For, throughout this period, English architecture was simple and direct in design, and sane in execution; we alone of European peoples steered clear of rococo art, the decadence of the Renaissance. Our latter work grew dull, even insipid; yet in a way it never lost its self-respect, and, at any rate down to the end of the last century, it suffered less than the art of other countries from the audacity of impudence. Even Nash and the plaster architects of the early part of this century were not so vulgar as the Germans of the eighteenth century. Yet it is unfortunately the case that for the last hundred years or more this tradition has been overlaid with fashion after fashion; first by Robert Adam, then by the graver but still artificial manner of Wilkin and Decimus Burton, and since their time by all sorts of aberrations, neo-French, Italian and Spanish Gothic, German and Flemish revivals, and a hundred other caprices which can have no permanent place in the history of English architecture.

It is indeed an open question whether any such tradition as I have attempted to indicate can grow up again in English art. Modern conditions are undoubtedly against it. The arts do not at this moment express the finest intelligence of the country. That intelligence is concentrated in other channels, and has left its mark in science, in immense commercial enterprise, in almost every form of intellectual activity other than the arts. The latter are not at present regarded as worthy of serious and sustained attention, and until some reasonable standard of judgment has grown into recognition among educated people it is not likely that there will be any general improvement in English architecture. It is at this point that a wider system of education might help the artist. It can do nothing for his technique, but it can at least help to find him the right environment.

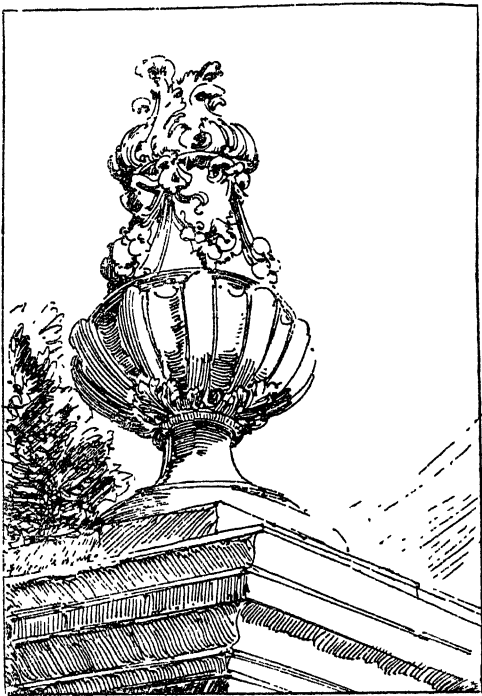

STONE URN ON GATE PIER, HAMPSTEAD MARSHALL.

*The Five Orders of Palladio
as given in
Freati's Parallel of the
Ancient Architecture with
the Modern*

*Note. Freati's module is the
semi-diameter of the Column
divided into 30 minutes or sub
divisions of the scale of
measurement.
The measurements of the
projections of members are
taken from the centre of the
Column. eg. in Palladio's
Tuscan Order 40 figured
to the die of the base means
that the width of half the
die is 40 minutes. 30 fig-
ured next the column
means that the half-
diameter is 30 minutes.
The figures marked ver-
tically to the right of
the centre line give the
heights of the various
members in minutes*

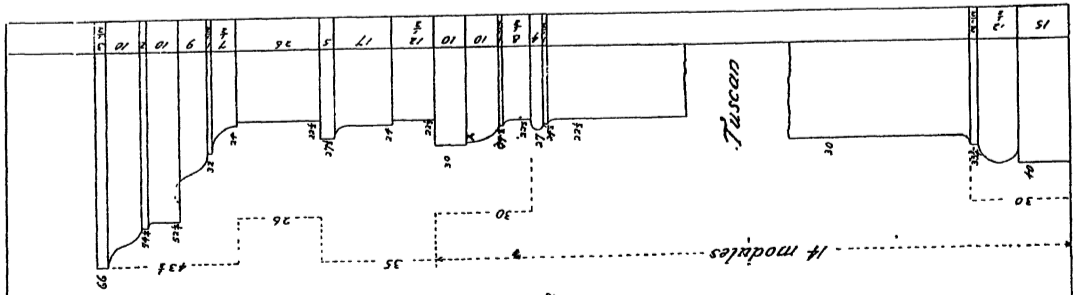

TUSCAN.

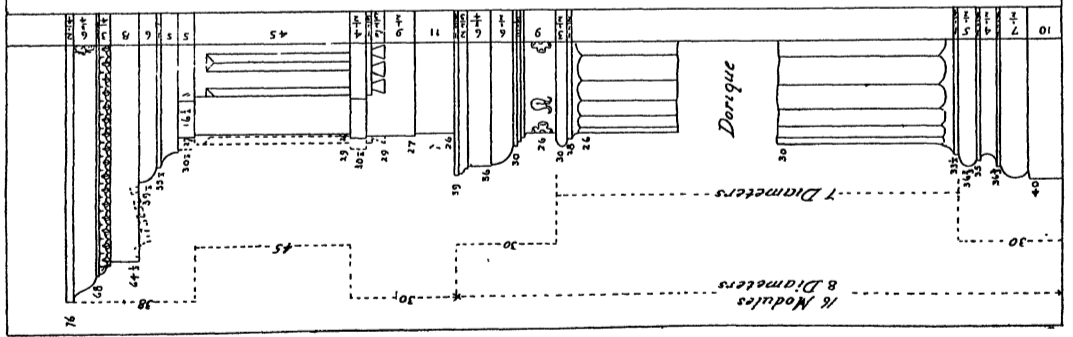

DORIC.

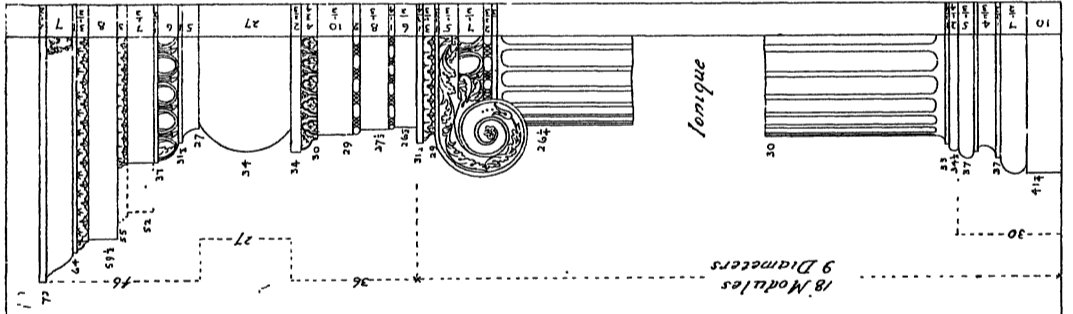

IONIC.

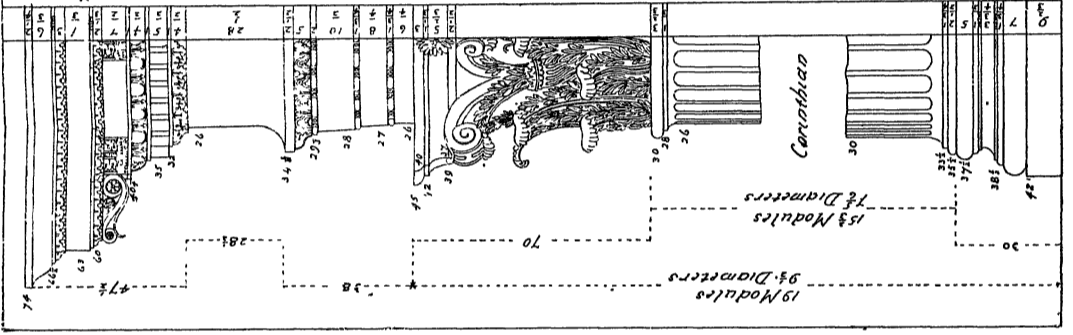

CORINTHIAN.

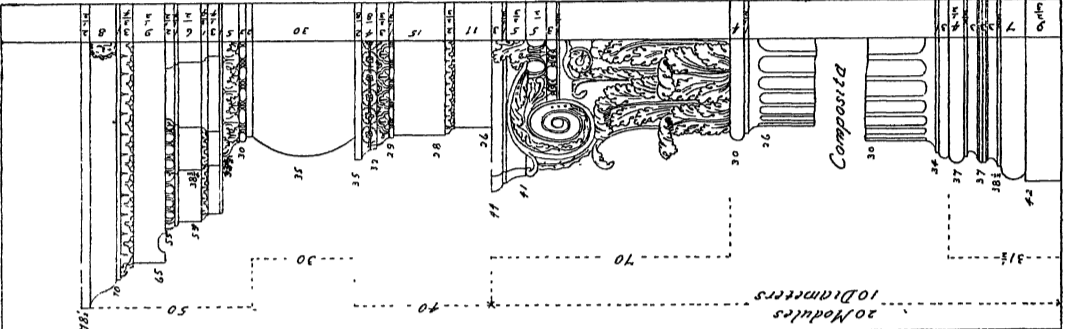

COMPOSITE.

*The Method of setting out the Entasis to the Shaft of a Column
Having set out the height and top and bottom diameters of the
Shaft to given dimensions - draw a line indefinitely from C through
D at right angles to the axis of the column. This done set off
distance CD which is the half diameter at bottom from
A the extreme point of the top half diameter to B a
point in the axis. Then from A through B draw
the line ABE which will cut the indefinite
line at base in E. From this point of inter-
-section E draw through the axis of the
column any number of rays on each of
which from the axis to the circum-
-ference set off the distance CD
thus obtaining any number
of points x x x through
which a curve may
be drawn which
will give the
Entasis*

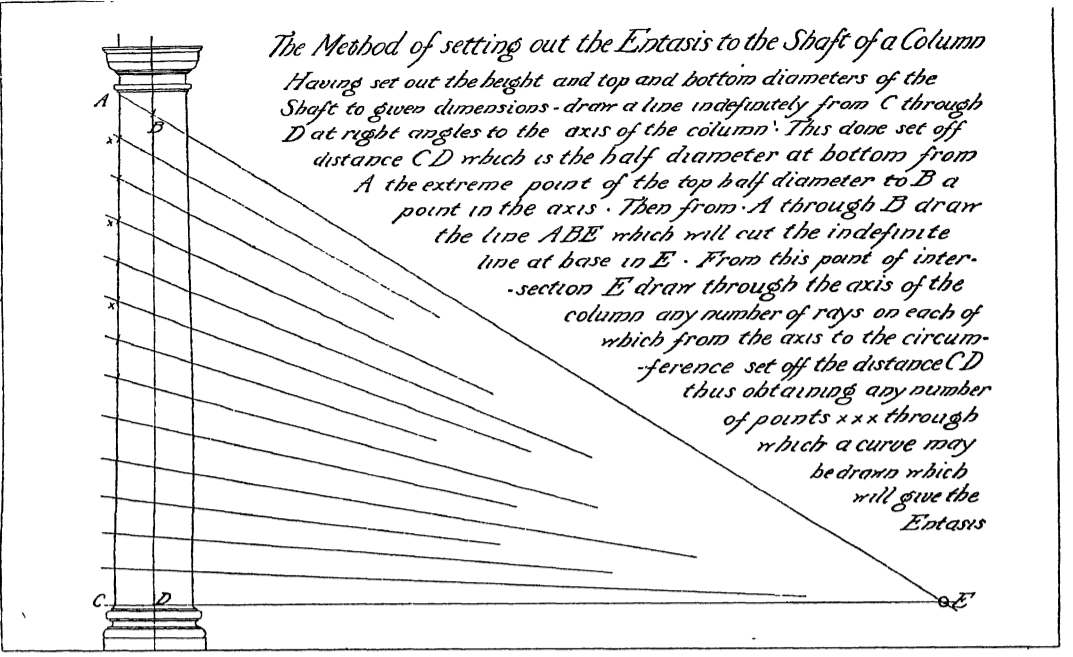

INDEX.

- Abbey Dore Church, restoration of, 43-44, 102-103.
- Abbot's Hospital, Guildford, 6.
- Abel, John, life and works of, 42-45; restoration of Abbey Dore Church, 102-103; Leominster Town Hall built by, 244; designs and work by, 246.
- Abingdon Town Hall, 195, 258; (illus.) 255.
- Acroyde, John, 42.
- Adam, James, life and works of, 209-215.
- Adam, Robert, life and works of, 209-215; Paine and, 195; Harewood House decorated by, 201; pilasters used by, 256; plaster and stucco work by, 280-282.
- Adam, Robert and James, life and works of, 194, 209-215; work at Kedleston, 196, 226; top-lighting practised by, 232; galleries by, 234.
- Adam, William, 209.
- Adams, provost of King's, Cambridge, 183.
- Adelphi Buildings, 209, 210.
- Admiralty, the, screen and gateway, 209, 213.
- Agecroft, 241 (note).
- Alberti, Leoni's English version, 172-173.
- Aldrich, Henry, Dean of Christ Church, work of, 160-162.
- All Hallows, Derby, 183.
- All Hallows, Lombard Street, 116.
- All Hallows, London Wall, 207.
- All Saints, Oxford, 160, 162, (illus.) 161.
- All Souls College, Oxford, Hawksmoor's work at, 158; gates, (illus.) 290.
- All Souls Library, Wren's drawings and plans in, 111, 123, 128, 130, 138, 175, 228; (illus.) 113, 125, 127, 141, 229.
- Allarton, Lord, Wren's design for house, 228.
- Allen, Ralph, 190.
- Almerigo, Paolo, villa by Palladio, 171, 174.
- Alresford Grange, 207.
- Altar-pieces, St. Margaret's and St. Nicholas Chapel, King's Lynn, 147; King's College Chapel, Cambridge, 163.
- Amesbury, garden house, (illus.) 58, plan, 59; Webb and, 89, 91; entrance pier, (illus.) 92; staircase, 222; walling at, (illus.) 249; stone work, 250.
- Amphill House, gallery at, 61.
- Anne, Queen, act for building fifty churches, 155.
- Answorth, Paine and, 195.
- Archer, Thomas, life and works of, 165-166; Cliefden House finished by, 146.
- Arlington Street, Earl of Yarborough's house in, 177.
- Arnold, William, 42.
- Artari, plaster work by, 180, 183, 185, 280.
- Arundel, tomb at, 6; brick house in, 269, (illus.) 270.
- Arundel, Earl of, Inigo Jones and, 71.
- Arundel House, old, 138.
- Ashburnham House, Inigo Jones and Webb's work at, 88-90, 91;

- staircase, 218, (illus.) 217; paneling, 247; plaster work at, 276; cornice and doorhead, (illus.) 277.
- Ashdown Park, 96.
- Astbury Church, 99.
- Astley Hall, gallery, 61.
- Aston Hall, staircase, 66.
- "Athenian Antiquities," by Stuart and Revett, 202.
- Atherton House, 154.
- Atkinson, John, 22.
- Audley End, 33, 37, 41, 253; entrance porch, 27; quadrangular plan, 51; plan of, (illus.) 53; gallery, 61; staircase, 68; plaster work, 274, 282; almshouses at, brickwork of, 264.
- Axwell Park, 197.
- Babington, Master, lead bought from, 283.
- Baguley, half timber houses at, 241 (note).
- Bagutti, plaster work by, 180, 183, 185, 280.
- Baker, Christopher, report on consumption of oakwood, 242.
- Banastre, Sir R., Passenham Church restored by, 99.
- Bank of England, old, 201.
- Barbaro, Daniel, 19.
- Barber Surgeons' Hall, 84.
- Barcheston, Flemish settlement at, 25.
- Barlborough Hall, 52, 57-58.
- Barrington Court, entrance front, 32; E-shaped plan, 54.
- Barry, alterations at Harewood by, 201 (note).
- Barsham Manor House, *see* East Barsham.
- Barthomley Church, 99.
- Basil, Simon, succeeded by Inigo Jones, 76.
- Basildon Park, 201.
- Basing House, 86.
- Bath, Abbey Church, 98; work of John Wood and son at, 190.
- Bath stone, use of, 185, 248.
- Beavor, half-timber houses at, 241 (note).
- Beavor House, 55.
- Beckford, William, 224.
- Bedford House, 96.
- Bedingfield, Sir Edward, 262.
- Bell, Henry, life and works of, 146-147.
- Benson, Wren's dismissal and, 138-140; design for house in "Vitruvius Britannicus," 168.
- Berkeley Square, Earl of Powys' house in, 177.
- Bernardi, Theodoro, 14.
- Bernini, 111.
- Berwick-on-Tweed Church, 106.
- Bethlehem Hospital, 195.
- Beverley, Sir Charles Hotham's house at, 168.
- Beverley Minster, Hawksmoor and, 159; part of gates (illus.), 291.
- Bildenden, half-timber houses at, 241 (note).
- Bilson, John, on re-introduction of brickwork, 261-262 (note).
- Bird, Thomas, figure carving at St. Paul's, 129.
- Bishop Auckland, Bishop Hackett's work at, 106.
- Bishop's Burton, house at, 96.
- Bishopsgate Street, Sir Paul Pindar's house in, 242.
- Blackheath, Morden College, 138; Sir G. Page's house near, 167.
- Blenheim Palace, elevation (illus.), 153; Vanbrugh and, 150-152, 154; Hawksmoor appointed deputy surveyor, 155; Chambers's work at, 203; plan, 224.
- Blickling, 253; chimney-pieces, 28; staircase, 66, 69; brickwork at, 264; plaster work, 274, 282.
- Bloomsbury, Alfred Place and Crescent, 208.
- Bloomsbury Square, No. 6, 232-233; houses in by Ware, 187.
- Bodleian Library, rain-water head at, 284.
- Bodley, Sir Thomas, schools at Oxford, 41, 104.
- Bold Hall, 172.
- Bolsover Castle, different styles, 39-

- 40; gallery at, 61; riding school, 94, 96-97.
- Bonomi, design for Eastwell, 226.
- Boreham Church, Sussex monument, 30.
- Boughton Malherbe, plaster work, 63.
- Bourne Pond, gables at, 265.
- Bowood, 207.
- Bradford-on-Avon, stone work at, 250.
- Bramham Park, 198.
- Bramshill, brickwork at, 264.
- Brancepath Church, 99.
- Brandenburgh House, 200.
- Brazenose College, 158; the chapel (illus.), 107; windows of, 104.
- Brede Church, monuments in, 13-14.
- Brettingham, Matthew, Kedleston designs, 196; Duke of York's palace designs, 232.
- Brewer, "Calendar of State Papers," extract from, 283.
- Brickwork, Wren's use of, 122, 130, 272; re-introduction and use of, 260-270.
- Bridgeman, garden designing, 178.
- Bridgewater House, gallery, 234.
- Bristol Exchange, 190.
- Britton and Pugin, on improvement in architecture, 215.
- Brocket Hall, 197.
- Bruce, Sir William, 226.
- Brympton, 89.
- Buckhurst House, plan of, 51.
- Buckingham, Duke of, description of Buckingham House, 229.
- Buckingham House, 109, 144-146, 223, 229-230.
- Buckland, Berks, 191.
- Builder-architects, 27, 70, 235.
- Builder-designer, transition stage to architect, 38-39, 40.
- Burford Church, Tanfelde tomb, 30; grille round, 288, (illus.), 288.
- Burford Priory, 104.
- Burghley House, 33, 34; building of, 24-25; chimney-stacks, 37; German work at, 37; quadrangular plan, 51.
- Burghley, Lord, *see* Cecil.
- Burleigh, ironwork at, 291.
- Burlington, Richard Boyle, Earl of, life and works of, 173-176; house at Chiswick, 171; Leoni employed by, 172; Flitcroft patronized by, 188; collection of drawings, 222.
- Burlington Gardens, Duke of Queensberry's house in, 173.
- Burlington House, Webb and, 96; Campbell's work at, 168-170; elevation (illus.), 169; colonnade, 172, 174; front and gateway, 174.
- Burrough, Sir James, life and work of, 162-163.
- Burton, Decimus, 303.
- Burton, Agnes, 52, 68, 253.
- Burton Park, 172.
- Burwash, doorway at (illus.), 247; chimney-stack, 266; panel at, 280; (illus.), 279.
- Bury St. Edmunds, half-timber houses in, 241.
- Bushey Park, 149.
- Bute, Lord, Sir William Chambers and, 202-203.
- Buxton, the Crescent, 201.
- Caister Castle, 262.
- Caius, Dr., and Caius College, 52.
- Caius College, "Porta Honoris," 27-28; stone column with sundial, 28; new court, 52; Sir J. Burrough and, 162.
- "Calendar of State Papers," extract from, 283.
- Camber Castle, brickwork, 263.
- Cambridge, amateurs at, 162-163; Gibbs's work at, 183-184; *see also* separate buildings.
- Cammermayer, 27.
- Campbell, Colin, life and work of, 168-172; "Vitruvius Britannicus," 76; work at Greenwich, 136; Wren and, 138-140, 143, 173; succeeded by Ripley, 173; work at Burlington House, 174; Chiswick Villa, 175; Lord Burlington and, 175-176; design for Wanstead, 188.

- Canons Ashby, ceilings, 273.
 Canterbury, Burgate Street, door-head in, (illus.), 19; St. Dunstan's Street, gateway in, 264; High Street, plaster work in, 275.
 Carlow, Lord, Gandon helped by, 206.
 Carpenter-architects, 245-246.
 Carpentry, conditions of work and change of style in, 237-248.
 Carr of York, life and work of, 191, 194, 201-202; Chambers recommended by, 202-203; design for Oakland House, 226; top-lighting used by, 232.
 Carshalton Park, 172-173; lead figures at, 287; gates and railings, 292.
 Carter, John, on house planning, 228, 229-230.
 Cartmel Church, 103.
 Cary, house at Roehampton, 165.
 Castle Ashby, 88-89.
 Castle Hill, 203.
 Castle Howard, 150, 224; Hawksmoor and, 155; gallery at, 234.
 Caux, Solomon de, work at Richmond, Wilton, etc., 30, 36.
 Cecil, Sir Thomas, Old Wimbledon House built for, 63.
 Cecil, Sir William, Burghley House and, 24-25.
 Ceilings, Theobalds, 63; Wilton, 86, (illus.), 85; Ford Abbey, 88; Wren's churches in, 116-120; Paine's, 198; Hampton Court Hall, 238-239; Middle Temple Hall, 238-239; Lambeth Palace Library, 238, 239, 241; plaster work, 273-274, 280-282; Inigo Jones's method of treating plaster, 276; design for drawing-room at Greenwich (illus.), 278; Gibbons's 279.
 Chambers, Sir William, life and work of, 186, 194, 202-206; ceilings by, 280.
 Chambord, staircase, 222.
 Charlecote, 24; gatehouse, 52.
 Charlemont, Lord, Casino at Marino, 203.
 Charles I., design for mausoleum, 130.
 Charles Church, Plymouth, 106.
 Charlton House, 52; gallery at, 61; ceilings, 273.
 Charterhouse, old, screens and mantelpieces, 27, 28; Chapel, Sutton's monument in, 30.
 Chastleton, 52.
 Chatsworth, drawings at, 76, 78; Campbell on, 147; stables at, 196; inner court, 226; gallery at, 234; ironwork, 291.
 Cheere, Sir Henry, Robert Adam and, 200.
 Cheere, John, lead yard of, 287.
 Chelsea Church, chancel of, 13; Dacre monument, 30.
 Chelsea Hospital, Wren and, 134; Hawksmoor and, 154.
 Chequers Court, 52.
 Chertsey Bridge, 197.
 Cheshire, half-timber buildings in, 237.
 Chester, Sir John, house at Isleworth, 185.
 Chesterfield House, 187.
 Chevening, Kent, 220, 222.
 Chichele and Lambeth Great Hall, 240.
 Chichester, house in West Street, 138, 268.
 Chicksand, 187.
 Chilham, alterations by Taylor, 200.
 Chimney-pieces, German, 28; Cobham at, (illus.), 29; Wilton (illus.), 87; sketch for, by Inigo Jones, (illus.), 89; at Drayton, 94; Northumberland House, drawings at Chiswick, 96.
 Chimney-stacks, introduction and use of, 265-266.
 Chimneys, columns used as, 27.
 Chiswick, drawings at, 76, 82, 86, 96; Lord Burlington's Villa at, 171, 174-175.
 Christ Church, Newgate Street, 116, 118-120, 182.
 Christ Church, Oxford, staircase, 104; gateway, 122; Clarke and

- 159; Peckwater quadrangle, 160; library at, 160, 256.
- Christ Church, Spitalfields, 157-158; (illus.), 156; plan of (illus.), 157.
- Christchurch, Hants, chantry, 15-16, (illus.), 17; carving on panel (illus.), 237.
- Christ's College, Cambridge, stairs (illus.), 69; Essex's work at, 163.
- Christ's Hospital, entrance, 130, 267.
- Christian IV. of Denmark, and Inigo Jones, 71.
- Chute, Chaloner, 94.
- Cibber, Caius, stone carving, 129, 132.
- Cisterns, lead, 283-284, (illus.), 283.
- City Churches, Laud and, 101-102; Wren's plans and rebuilding, 114-122.
- City Halls, Wren and, 129; Jarman and, 143.
- Clandon, Surrey, 172.
- Clare College, 256-257; materials for, 21; chapel, 163.
- Clare, Suffolk, plaster work at, 274.
- Clarendon Press buildings, 159, 256, 291.
- Clark, Thomas and Charles, plasterers, 282.
- Clarke, Dr., work at Oxford, 159, 160-162, 256.
- Clerissau, Chambers working under, 202.
- Cleifden House, old, 144-146, 223.
- Cobb's Hall, ceiling of, 272.
- Cobham, chimney-piece, 28 (illus.), 29; gateway (illus.), 47; Inigo Jones and, 88.
- Coggeshill, chapel barn at, brick-work of, 260.
- Colchester, Flemish settlement at, 25.
- Coleorton, 207.
- Coleshill, 88, 94, 220-222; staircase, 218.
- College of physicians, design for rebuilding, 90.
- College of Surgeons, 208.
- Collins, plasterer, 282.
- Compton, Warwickshire, 210.
- Coom Bank, 200.
- Coomb Abbey, 144, 146.
- Cooper, Sir John, pavilion of, 185.
- Copenhagen Bourse, 71.
- Cork Street, General Wade's house in, 174.
- Corpus College, garden front, 160.
- Corsham, school and almshouses (illus.), 46; E-shaped plan, 54; doorhead, 250 (illus.), 253.
- Cosin, Bishop, gifts to Peterhouse, Cambridge, 102; work at Bishop Auckland, 106.
- Courtyard houses, 49-56.
- Covent Garden, plan of house in, 228; St. Paul's Church, 81.
- Cowick Hall, 196, 198.
- Cranborne Manor, 55; staircase at, 68; Inigo Jones and, 88.
- Cranbrook, half-timber houses at, 241 (note).
- Crane, Sir Francis, and Stoke Park, 89.
- Craven, Lord, and Hampstead Marshall, 97, 98.
- Cromwell, Ralph, Lord, 50.
- Currey Rivell, iron grille at, 288.
- Custom House, King's Lynn (illus.), 145; Dublin, 206, 207.
- Cusworth, 198.
- Dacre monument, Chelsea, 30.
- Dance, George, life and work of, 191-192; old London Bridge, design for arch, 201.
- Dance, George, the younger, life and work of, 192, 207-209.
- Demans and Demyans, *see* Majano.
- Denham, Sir John, appointed surveyor of works, 96; Wren and, 110, 112.
- Deptford Church, 166.
- Derby House, 241 (note).
- Derby, Lord, house in Grosvenor Square, 210, 211.
- Design for a church, probably St. Paul's, Covent Garden (illus.), 81.
- Devonshire House, 177; gates, 292.
- Dietterlin, Wendel, 27.

- Diocletian's Palace, 209.
 Ditchley, 185.
 Dixter, old houses at, 265.
 Doncaster, Mansion House, 195, 198.
 Doorways, St. John's College, Oxford (illus.), 2; Tenterden, Kent (illus.), 23; Queen Street, King's Lynn (illus.), 148; *see also* Gateways.
 Dover House, Whitehall, 196.
 Dowsing, W., decorations in Peterhouse Chapel destroyed by, 102.
 Drake, "Eboracum," 175.
 Drayton, mantelpieces by Webb, 94.
 Drury Lane Theatre, 210.
 Dublin, Gandon's work at, 206-207; Trinity College, Sir W. Chambers' work at, 203.
 Dudingstone, 203.
 Duncombe, Mr., house of, 152.
 Duncombe Park, 154, 226.
 Dunton Park, 201.
 Durham Cathedral, pillars, 299.
 Durham, Cosin, Bishop of, Peterhouse Chapel and, 102.
 Durham House, designs for rebuilding, 88.
 Dutch in England, influence on architecture, 25-30.
 Dynham House, 147.
 E-shaped plan, 54-56.
 Eagle House, Bathford, 190.
 East Barsham Manor House, brick and terra-cotta work at, 6, 262; chimney, 266.
 Eastbury, Dorset, 152.
 Eastwell, 226.
 Edinburgh Record Office, 210, 211, 212.
 Edinburgh University, Adam's designs for, 210.
 Elizabeth, Queen, monument to, 30; church building in reign of 99.
 Ellastone Church, 99.
 Eltham Club House, 138, 222; plans of (illus.), 221.
 Ely, Bishop West's Chapel, 16; ceiling of, 273; gates, 288; Chapter House, 300.
 Ely House, Dover Street, 201.
 Emmanuel College, Cambridge, 41; Essex's work at, 163.
 Emmanuel Hospital, 138, 267.
 Essex, half-timber buildings in, 237.
 Essex, James, life and work of, 163.
 Evelyn, Wren and, 110.
 Exeter College Chapel, 41.
 Fastolf, Sir John, 262.
 Faulkourn Hall, brickwork, 262.
 Faversham Church, 192.
 Fell, Dean, 104.
 Fenwicke, Colonel, Berwick Church built by, 106.
 Fergusson, James, on St. Martin's-in-the-Fields, 180-183; on Newgate and the Mansion House, 208.
 Finchcox, house at, 230.
 Finsbury Square, Dance Junior, and, 207-208.
 Fitzroy Square, the Adams and, 210, 213; stucco work in, 280.
 Fitzwilliam, Lord, Milton House built for, 185.
 Flemings in England, influence on English builders, 25-30, 294; re-introduction of brickwork by, 260, 261, 262 (note).
 Flitcroft, life and works of, 186, 187-189, 192; death of, 194; succeeded by Chambers, 203; Woburn Abbey design, 226.
 Fontana, C., Gibbs a pupil of, 179.
 Fonthill, 224.
 Foot's Cray, 171.
 Forcet, 198.
 Ford Abbey, Inigo Jones and, 88; plaster work at, 276.
 Foremark, 200.
 Forest of Dean, half-timber buildings in, 237.
 Fountains, lead, 284.
 Fountains Hall, plan of, 56; staircases at, 66.
 Fourdrinier, 188.
 Fréart, 70 (note) and plate at end.

- Fredericksborg, Castle of, 71.
 Frisius, J. V., 27.
 Fulmer Church, 99.
- Gables, corbie step and other, 264-265.
- Galleries, the great gallery, 216, 218; proportions of, 234; survival of, 234; of inns, 56; Elizabethan and other houses in, 60-63.
- Gandon, James, life and work of, 206-207; on architecture in eighteenth century, 167.
- Garden architecture, Kent and, 178.
- Gardening, "Theory and Practice of," by John James, 166.
- Gardiner, Stephen, chantry and tomb of, 16.
- Gatehouses, 50, 52; Sandwich (illus.), 251.
- Gateways, Cobham College (illus.), 47; Botanical gardens, Oxford, 82; Oatlands Park, 82; Sandwich and Canterbury, 264.
- Gayton Manor House, plan of, 59.
- George I., and Wren, 138.
- George II., lodge in Richmond Park, 200.
- Gerbier, Sir Balthazar, life and work of, 97-98, 109.
- Germans in England, influence on English work, 20, 24-32, 273, 294.
- Gibbons, Grinling, work at St. Paul's, 129; Hampton Court, 132; Ripley succeeds, 173; carving by, 279.
- Gibbs, James, life and work of, 179-186; Wren and, 143; succeeded by Hawksmoor and James, 155; designs for King's College, Cambridge, and Radcliffe Library, Oxford, 158; death of, 194; method of lighting, 230; rules for proportion of rooms, 233; on Artari and Bagutti, 280.
- Gibside, buildings at, 198.
- Glasgow Infirmary, 210.
- Glastonbury, Flemish settlement at, 25.
- Godalming, brick work at, 266.
- Godinton, staircase, 66.
- Goodwood, Campbell's design for, 172.
- Gopsall Hall, 207.
- Gorges, Sir Thomas and Lady, 36.
- Gosforth House, 196, 197, 198.
- Gosford House, 210.
- Gotch, J. Alfred, on buildings in Northamptonshire, 248; gables at Bourne End, 264.
- Gothic, last survivals of, 98-108; the Reformation and, 98; seventeenth century, 100; tradition in masonry, 100; tradition at Oxford, 104; latest examples of, 106.
- Gower, Lord, house in Whitehall, 204.
- Grange, The, in Hampshire, 88.
- Great Cressingham Priory, 262.
- Great Snoring Rectory, brick and terra-cotta work, 6, 262; (illus.), 261.
- Great Queen Street, brick houses in, 91, 267.
- Green Park, Ranger's lodge, 210.
- Greenwich Hospital, 134-138, 142, (illus.), 83; Inigo Jones's work at, 84, 134, 226; Wren and, 84; Webb and, 91, 134; elevation, (illus.), 137; Vanbrugh and, 152; Hawksmoor and, 154; Campbell on, in "Vitruvius Britannicus," 168; Ripley's work at, 173; interior of chapel rebuilt, 202; design for ceiling, (illus.), 278; banqueting house, accounts for lead work, 283-284.
- Greenwich, Queen's House, 76, 84, 220, 222.
- Greham, Sir Thomas, 25; College of, 143; Exchange, 267.
- Grimsthorpe, 152, 226.
- Groombridge, Kent, 138, (illus.), 139; plan of (illus.), 140; brick-work at, 267-268.
- Grosvenor Square, Lord Derby's house in, 210, 211.
- Grumbold, Robert, life and works of, 21, 49, 256-258.
- Grumbold, Thomas, 49, 256.

- Guildford, Abbot's Hospital, 6;
Town Hall, 244; ironwork of,
289; casement-fastener, (illus.),
289.
- Gunnersbury, 89, 96.
- H-shaped plan, 54-56, 228.
- Hacket, Bishop, work at Lichfield,
106.
- Hackwood, Gibbs's work at, 185.
- Haddon Hall, earlier part of, 50;
gallery at, 61; ceilings, 273;
rain-water heads, 284.
- Hadleigh, Flemish settlers at, 260.
- Hall, the, uses of, 59-60.
- Hall Barn, garden house at, 172.
- Hammersmith, St. Paul's Church,
102.
- Hampstead Marshall, 97-98, 144,
146; stone urn at (illus.), 304.
- Hampton Court, Wolsey and, 4, 6;
chapel fittings broken up, 8;
carvings in hall, 18; gatehouse,
50; gallery, 61; modelled orna-
ment at, 63; gates, 129, 289-291,
(illus.), 135; Wren's designs and
work at, 132, 142, 226; north-
east corner (illus.), 133; Talman
at, 147-149; roof of hall, 238-
239; rain-water heads at, 244;
panelling, 247; brickwork, 262;
chimneys, 266; leadwork, 283,
285; Italian work at, 293.
- Handicrafts connected with architec-
ture, 236-292.
- Hanley Church, 106.
- Hardwick, gallery at, 61; plaster
work, 63; friezes, 272-273; lead
figures at, 287.
- Hare Hall, Essex, 198.
- Harewood House, Yorks, 201.
- Harewood Place, corner house, 210.
- Harlow, Sir Robert, 8.
- Harrison, John, 100.
- Hatfield, screens and mantelpieces,
27, 28; staircase, 66, 69; gallery
at, 234; brickwork at, 264.
- Hatton, Sir Christopher, 34.
- Haveus, Theodore, 28.
- Hawkhurst, staircase at, (illus.) 67.
- Hawkesmoor, Nicholas, life and work
of, 149, 154-160; work at Green-
wich, 136; Vanbrugh and, 143;
James succeeds at Greenwich,
166; portico at St. George's,
Hanover Square, 167; design for
King's College, Cambridge, 183.
- Headcorn, half-timber houses at,
241, (note), 265.
- Heath House, 195.
- Heathfield, 268.
- Heberden, Dr., house in Pall Mall,
plan of, (illus.) 231.
- Henchman, Bishop, first stone of
St. Paul's laid by, 129.
- Henry VII., chapel and tomb of,
6-8.
- Henry VIII., workmen imported
by, 1, 4, 6, 11, 14; tomb of, 8,
9-11.
- Herbert, George, Leighton Brome-
wood Church built for, 99.
- Herbert, Lord, house in Whitehall,
172.
- Hereford, Shire Hall, 42, 43;
Butcher's Row, carving in, 45.
- Hertford, plaster work on house in,
275.
- Hertford monument, Salisbury, 30.
- Heveringham Hall, 201.
- Heythorpe Hall, 165.
- Higham Ferrers Church, 99-100.
- Hiorns, the, buildings designed by,
200.
- Holbein, Hans, 11, 14.
- Holdenby, 33, 34.
- Holkham Hall, 177, 226; gallery
at, 234.
- Holland House, 33, 34, 38; plan of,
(illus.) 54.
- Holt, Thomas, life and work of, 41,
246.
- Hopetown House, 226, 230.
- Horse Guards, Kent and, 177;
Vardy and, 189.
- Horseheath Hall, 96.
- Hotham, Sir Charles, 168.
- Houghton Hall, Campbell's work
and design, 170-171, 172; Ripley's
work at, 173; ceilings, 176;
Ware's plates of, 116.

- House planning, Robert Adam and, 211-213.
- Howe, Lord, 201.
- Hull, Holy Trinity Church, 260.
- Hulsbergh, engraver, 188.
- Hunsdon, Lord, monument to, 30.
- Hurstmonceaux, 262.
- Hyde Park, plans for barracks, 138; triumphal arch, 172.
- Iffley achway, 299.
- Inns, old, long galleries of, 56.
- Inverary Castle, 198.
- Ipswich, Sparrow's house at, 242-244, (illus.) 245; plaster work at, 274.
- Ironwork, history and use of, 287-292.
- Isleworth, Sir John Chester's house at, 185.
- Italian workmen in England, work and influence of, 3-18, 19-20, 272, 293, 294.
- Jacobean house, 216.
- James I., church building in reign of, 99.
- James, John, life and work of, 166-167; Gibbs succeeded by, 155; death of, 194.
- Jansen, Bernard, 30.
- Jarman, Edward, work of, 129, 143-144.
- Jennings, Richard, chief carpenter of St. Paul's, 129, 166.
- Jerman, *see* Jarman.
- Jersey, Thomas, and Paine, 194.
- Jesus Chapel, Oxford, 104.
- Johnson, Mr. Secretary, house at Twickenham, 185.
- Jones, Inigo, life and works, 71-90; supersedes De Caux, 30; method of house planning introduced by, 56, 216-223; Palladio's orders and English architecture, 70 (note); Webb and, 91; St. Catherine Cree and, 101; St. Alban's, Wood Street, built by, 102; work at Greenwich, 134, 226; "Some designs by Mr. I. Jones and Mr. W. Kent," 177, 189-190; designs published by Ware, 186; designs published by Kent, 188, 222; masonry work of, 254; plaster work, new method introduced by, 273, 275-276.
- Jonson, Ben, 298.
- Juxon, Archbishop, rebuilding of Lambeth Hall, 240-241.
- Kedleston, 196, 209-210, 226; plan of, (illus.) 197; top-lighted hall, 232.
- Keene, Whitsed, 203.
- Kemp, Peter, Burghley House and, 24.
- Kensington Palace, Wren and, 134; Hawksmoor and, 154; ceilings of, 176; rubbed brickwork at, 267.
- Kent, Weald of, foreign settlements in, 25-26, 263; half-timber buildings in, 237, 241, 265; scarcity of timber, 242.
- Kent, William, life and works, 173, 176-178; publication of designs and drawings by Inigo Jones and others, 76, 78, 175, 188, 189, 190, 222; Lord Burlington and, 175-176; villa at Chiswick, 175; plates of Houghton Hall, 186; succeeded by Flitcroft, 188; Vardy, pupil of, 189.
- Kenwood House, 210; section of the library (illus.), 214; stucco work at, 282.
- Kew Bridge, 197.
- Kew Gardens, Chambers' work in, 203.
- King's Bench Walk, brickwork in, 267.
- King's College, Cambridge, Hawksmoor's plans for, 158; chapel, 163, 301; gardens, 163; new buildings, 183-184.
- King's Lynn, Custom House (illus.), 145; buildings by Bell, 146-147; doorway in Queen Street (illus.), 148; half-timber houses in, 241; Guildhall, 250; ironwork, 292.
- King's Road, Chelsea, house in, 173.

- King's Weston, 152.
- Kirby, Northamptonshire, Thorpe and, 33-34, 36; quadrangular plan, 51; Inigo Jones and, 88.
- Kirby Hall, Yorkshire, 200, 201.
- Kirtlington, 200.
- Knole, chimney-pieces, 28; gable at (illus.), 35; colonnade, 244; ceiling in gallery, 273; rain-water head, 284.
- Kyp's "Britannia Illustrata," 144.
- Lake House, 4; stonework at, 250.
- Lamberhurst, 265.
- Lambeth Palace Library, roof of, 238, 239-241.
- Lampport Hall, 96.
- Lancashire, half-timber buildings in, 237.
- Laneborough House, 187.
- Lanhydrock, gatehouse, 52, 250.
- Lansdowne House, 210, 211.
- Latham Hall, 172, 226; plan of (illus.), 227.
- Laud, Archbishop, and the building of churches, 99, 101, 102.
- Lavenham, half-timber houses in, 241.
- Layer-Marney, terra-cotta work at, 6; quadrangular arrangement, 50; builder of, 263.
- Lead work, 282-287; use of, by Wren, 122.
- Ledbury, Market Hall, 244.
- Lee, Sir Henry, Quarrendon Church restored by, 99.
- Leeds, St. John's Church, 100.
- Leighton Bromswold Church, 99.
- Lenham, 241 (note).
- Lenôtre, system of garden architecture, 166.
- Lenthall, Speaker, Burford Priory built by, 104.
- Leominster Church, rain-water head at, 284.
- Leominster, Market Hall, 43; Town Hall, 244.
- Leominster Grange (illus.), 44.
- Leoni, Giacomo, life and work, 172-173; colonnade at Burlington House, 174; Lord Burlington and, 175-176; Latham Hall and Moor Park designs, 226.
- Leybourne, William, revised edition of Primatt's "City and County Purchaser and Builder," by, 234.
- Liardet, patent stucco, 210, 280.
- Lichfield, Bishop Hacket's work at, 106.
- Lincoln College Chapel, Oxford, 104.
- Lincoln's Inn Fields, Inigo Jones and, 76; Lindsay house in, 84; Newcastle House in, 144; stone buildings in, 200; College of Surgeons, 208; houses on west side of, 254.
- Lindsay House, 76-84; plan of, 218-220 (illus.), 219.
- Litchfield Lord, Ditchley built for, 185.
- Little Wenham Hall, Suffolk, 260.
- Littlecote, 32, 40, 253; staircase, 66; ceiling of hall, 274.
- Liverpool Exchange, 190.
- Lloyd, Sir Nathaniel, lead figures given by, 287.
- London, the great fire, 112; Wren's plans for rebuilding, 112-114 (illus.), 113; City churches and Wren, 114-122; City halls and Wren, 129.
- London Bridge, old, Hawksmoor and, 159; Dance's and Taylor's work on, 201.
- Longford Castle, 28, 33, 34, 36, 37; plan of, 59; stonework at, 250.
- Longleat, 14, 24, 25; screens and mantelpieces, 27; Smithson and, 39.
- Lorenzo, Antonio di Piergiovanni, 9.
- Losely, chimney-pieces, 28.
- Louvre, the, 111.
- Lower Peover Church, 99.
- Ludlow Church, Walter monument, 288.
- Luton House, 210, 211; plan of (illus.), 211.
- Lyme Hall, 172.
- Lytham Hall, 201.
- Lytes-Cary, chapel, 100, 103-104 (illus.), 105; ceiling, 274.

- Lyveden, new building, 34-36; plan of, 59.
- Maiden Bradley, 228.
- Maidenhead Bridge, 201.
- Maidstone, Bank Street, plaster work in, 275.
- Majano, Benedetto di Nardo da, 9, 18.
- Majano, Giovanni da, 4, 9, 11.
- Majano, Girolamo, 9.
- Mansfield Street, the Adams and, 210.
- Mansion House, 191-192; design for by Ware, 186; pediment carved, 200; Fergusson on, 208.
- Mantel-pieces, *see* Chimney-pieces.
- Mapledurham, chimneys at, 266.
- Mar, Lord, Gibbs helped by, 179.
- Marino, Casino at, 203.
- Market Cross, King's Lynn, 147.
- Marlborough House, Wren's work at, 133, 228.
- Marsh, architect, 96, 97.
- Mary, Queen of Scots, monument to, 30.
- Masonry, Gothic tradition in, 100; conditions of work and change of style in, 237, 248-259.
- Masques, Inigo Jones's designs for, 74-75.
- Meare, plan of Fishing-house, 55.
- Melbourne, rain-water head, 285; lead vases and figures, 286, 287.
- Melbourne, Lord, house in Piccadilly, 203-204.
- Mellerstane, plaster work at, 282.
- Melton Constable, ceiling, 279.
- Merchant Taylors' Company, St. Peter's Wolverhampton and, 99.
- Mereworth, Campbell's villa at, 175.
- Mereworth Castle, 171.
- Merton College, Holt and, 41.
- Middle Temple, entrance, 267; Hall, roof of, 238, 239.
- Mills, City Surveyor, 129.
- Milton House, 185.
- Mistley Church, 210.
- Montacute House, gateway, 32, (illus.), 31.
- Montague House, old, 223.
- Monument, the, 129.
- Moor Park, Herts, 172, 226; plan of (illus.), 225.
- Morden College, 138.
- More Chantry, Chelsea Church, 13.
- Morley and palace of Wolvesey, 130.
- Morris, Robert, life and work of, 198-200; Kirby Hall designs, 201.
- Morris, Roger, 198.
- Moreton Hall, gallery of, 61.
- Morton Old Hall, 241 (note).
- Moulsham, Essex, 172.
- Muchelney, priest's house at, 55.
- Mymms, North, E-shaped plan of, 54.
- Nantwich Church, 99.
- Nash, 303.
- Newark, Town Hall, 201.
- Newbury, church, chancel gates, 288; High Street, brickwork in, 267.
- Newby, 170.
- Newcastle, Duke of, monument by Gibbs, 186.
- Newcastle House, 144, 146; Wynne's design, 228.
- Newgate Prison, 207, 208-209.
- Nonesuch Palace, building of, 11-13; gatehouse, 50; plaster work at, 272, 274.
- Norfolk, brickwork in, 260.
- Norfolk, Duke of, design for house for, 138; old Manor House at Worksop, 196.
- North Runcton Church, 147.
- Northumberland House, Webb working at, 96.
- Nost, John Van, lead yard of, 287.
- Nostell Priory, 195-196, 226.
- Nottingham, Mr. Plumtre's house at, 170; County Hall and prison, 206.
- Nottingham Castle, 96, 97.
- Nunziata, Toto del, 6, 9, 11.
- Oakland House, 226.
- Oatlands Park, gateway, 82.
- Ogle, C., house at Twickenham, 185.

- Oriel College, 104.
 Osterley Park, 210.
 Oulton Hall, 152.
 Oxburgh Hall, 265.
 Oxford, Botanical Gardens, gateway, 82; Gothic tradition at, 104-106; Sheldonian Theatre, 110-111; Hawksmoor's work at, 158-159; Vanbrugh's work at, 159; amateurs at, 160-162; Gibbs's work at, 184-185; Town Hall, 187.
- Padua, John of, 14.
 Page, Sir Gregory, 167.
 Paine, James, life and work of, 195-198; design for Kedleston, 209-210; designs for Fonthill, 224; design for Nostell, 226.
 Palladio, Andrea, orders introduced into England by Inigo Jones, 70 (note); influence in England, 143, 164; works of, Leoni's translation, 172; Dean Aldrich's notes on, 160; design for villa, 171, 174; Ware's translation of works, 186; rules of proportion followed, 233.
 Pall Mall, Dr. Heberden's house in, plan of (illus.), 231.
 Panel, Burwash, (illus.), 279.
 Panelling, 246-248.
 Papworth, Joseph, plasterer, 282.
 Parham, gallery at, 61; lead vases at, 286, (illus.), 287.
 Park Lane, house by Paine in, 196.
 Parliament, Houses of, designs for by Ripley and Kent, 173.
 Pas, Henry de, 26.
 Passenham Church, 99.
 Pembroke, Philip, Earl of, building of Wilton, 86.
 Pembroke, William, Earl of, Inigo Jones and, 71.
 Pembroke College, 110.
 Penacchi Girolamo, *see* Trevigi.
 Penni, Bartolommeo, 6, 11.
 Penshurst, lead vases at, 286.
 Perrault, "Treatise of the Five Orders," translated by James, 166.
- Peterhouse, chapel and cloisters, 102; Sir J. Burrough and, 162.
 Petre, Lord, 196.
 Piccadilly, house by Chambers in, 203-204; lead yards in, 287.
 Pindar, Sir Paul, house of, 242.
 Planning, sixteenth century, 49-70; seventeenth and eighteenth centuries, 216-235.
 Plaster work, coloured and modelled, 63, 64; introduction and use of, 268, 272-282.
 Plumber's work, 282-287.
 Plumtre, Mr., house at Nottingham, 170.
 Plymouth, Charles Church, 106; St. Andrew's, 106.
 Pockock's School, Rye, brickwork of, 267.
 Portland Place, the Adams and, 210.
 Portland stone, use of, by Wren, 122, 248.
 Powis, Lord, Newcastle House designed for, 146; house in Berkeley Square, 177.
 Pozzo, "Rules and Examples of Perspective," translated by James, 166.
 Preston, George, Cartmel Church repaired by, 103.
 Price, builder, St. George's, Great Yarmouth, designed by, 258.
 Primatt, Stephen, 234.
 Prior Park, Bath, 190.
 Probosc Church, 99.
 Pugin and Britton, *see* Britton.
- Quadrangular plan, 50-52.
 Quarendon Church, 99.
 Queens' College, Cambridge, gallery of, 61; Sir J. Burrough and the old hall, 162; brickwork of, 262; gates, 292.
 Queens' College, Oxford, library, 130; Wren's and Hawksmoor's work at, 154-155, 158-159.
- Radcliffe Library, Hawksmoor's and Gibbs's designs, 158, 184; Wren's influence on, 185; spandrel (illus.), 281.

- Ragdale Old Hall, 40.
 Rain-water heads, lead, 284-285.
 Ramsbury, 96.
 Raynham Park, Norfolk, 88; ceilings, 176; plan, 218; rubbed brick-work, 266; plaster work, 276.
 Redland Court, 190.
 Revett and Stuart, "Athenian Antiquities," 202.
 Reynolds, Sir Joshua, on Vanbrugh, 149-150, 224.
 Richmond, picture gallery, 30; bridge, 197; park, George II.'s lodge in, 200; observatory, 203.
 Richmond, Margaret, Countess of, monument to, 8.
 Ridge, Richard, 18.
 Ripley, life and work of, 173; work at Greenwich, 136-138; work at Houghton, 170; plates of Houghton Hall, published, 186.
 Rodes, Francis, 57.
 Roehampton, Cary's house at, 165.
 Rolls Chapel, terra-cotta tomb in, 5, 6.
 Rolls House, Chancery Lane, 170, 172.
 Roofs, waggon, 120; hammer-beam, 238-241.
 Rookby Hall, York, 154; Ware's plates of, 186.
 Rooms, rules for proportions of, 233, 234.
 Rose, plasterer, 282.
 Rosenberg Palace, 71.
 Rothwell market house, 35-36.
 Royal Exchange, Sir Thomas Gresham's exchange, 26-27; Jarman and, 129, 143-144.
 Rovezzano, Benedetto da, 9-11, 18.
 Rushton Manor, 35-36, 52; triangular lodge, 36, 59.
 Rycott Church, 110, 104.
 Rye, East Street, brickwork in, 263; Pockock School, 267.
 Sackville College, lead cistern at, 284.
 St. Alban's, Wood Street, 76, 102.
 St. Alphege, Greenwich, 157, 167.
 St. Andrew's, Holborn, 120.
 St. Andrew's, Plymouth, 106.
 St. Andrew's by the Wardrobe, 120, 182.
 St. Anne's, Limehouse, 157.
 St. Antholin's, 118.
 St. Bartholomew the Less, 209.
 St. Bartholomew's, Smithfield, 185.
 St. Basil's, Gracechurch Street, 116.
 St. Benet Fink, 118.
 St. Benet's, Gracechurch Street, 116.
 St. Benet's, Upper Thames Street (illus.), 119.
 St. Botolph's, Aldgate, 192.
 St. Bride's, Fleet Street, 118-120, 121; steeple (illus.), 117.
 St. Catherine Cree, 101, 182.
 St. Catherine's Hall, Cambridge, contract for, 22; Ramsden Buildings, 163.
 St. Charles the Martyr, 276.
 St. Clement Danes, 120, 180, 279-280.
 St. Cross, Winchester, 16.
 St. Donat's Castle, terra-cotta bust at, 5.
 St. Dunstan's-in-the-East, 102, 122.
 St. Edmund's, Lombard Street, 116.
 St. Fagan's Castle, lead tank at, 284.
 St. George's, Bloomsbury, 157, 167.
 St. George's-in-the-East, 157.
 St. George's, Hanover Square, 167.
 St. George's, Great Yarmouth, 258 (illus.), 257.
 St. Giles'-in-the-Fields, 157, 188.
 St. Gilles, 300.
 St. James's, Piccadilly, 182.
 St. James's, Westminster, 120.
 St. James's Square, Sir Watkin Wynne's house in, 210, 212.
 St. John, Oliver, Thorpe Hall built for, 94.
 St. John's, Hampstead, 188.
 St. John's, Leeds, 100.
 St. John's, Westminster, 165, 166.
 St. John's College, Cambridge, Simons and, 42; gallery of, 61; library, 100; Essex's work at, 163; gables, 265; rain-water head at (illus.), 285.

- St. John's College, Oxford, garden doorway (illus.), 2; rain-water head, 284.
- St. John's Hospital, Bath, 190.
- St. Lawrence, Jewry, 116, 279.
- St. Leonard's, Shoreditch, 192, (illus.), 193.
- St. Luke's, Old Street, 192.
- St. Luke's Hospital, 208, 209.
- St. Magnus, 120.
- St. Margaret Pattens, 121.
- St. Margaret's, King's Lynn, 147.
- St. Martin's, Ludgate Hill, 121-122.
- St. Martin's-in-the-Fields, 180-183, 186, 280.
- St. Mary Abchurch, 118.
- St. Mary Aldermary, 120, 122.
- St. Mary-le-Bow, 120, 121, 192.
- St. Mary-le-Strand, 179-180; (illus.), 181.
- St. Mary Somerset, 116.
- St. Mary the Great, Cambridge, Doctor's gallery, 162.
- St. Mary Woolnoth, 155, 157.
- St. Mary's, Oxford, 82.
- St. Mary's Hall, Oxford, 104.
- St. Mary's, Twickenham, 167.
- St. Matthias, Bethnal Green, 192.
- St. Michael's, Cornhill, 122.
- St. Michael's, Queenhithe, 116.
- St. Mildred's, Bread Street, 118.
- St. Nicholas Chapel, King's Lynn, 147.
- St. Nicholas Cole Abbey, 116.
- St. Nicholas, Cornhill, 120.
- St. Olive's, Hart Street, 102.
- St. Olave's, Tooley Street, 188.
- St. Paul's Cathedral, rebuilding, plans for, 114, 122-129; plan of (illus.), 125; drawing by Wren of (illus.), 127; cost of, 129; Wren's design for the surroundings, 132; James appointed assistant surveyor, 166; Tijou's work at, 291.
- St. Paul's, old, Inigo Jones and, 82; repairs to, 98; Wren and, 111; work on ruins of, 122.
- St. Paul's, Covent Garden, 82, 98; probable design for (illus.), 81.
- St. Paul's, Hammersmith, 102.
- St. Peter's, Cornhill, 120.
- St. Peter's, Covent Garden, 292.
- St. Peter's, Vere Street, 183.
- St. Peter's, Wolverhampton, 99.
- St. Philip's, Birmingham, 165-166; (illus.), 165.
- St. Stephen's, Walbrook, 116-118; (illus.), 115.
- St. Swithin's, Cannon Street, 118.
- St. Trophimus, Arles, gateway, 300.
- Salisbury, Countess of, chantry at Christchurch, 15-16, (illus.) 17.
- Salisbury Cathedral, Hertford monument in Lady Chapel, 30; contrasted with Notre Dame, 300.
- Salisbury Close, school-house in, 138; brickwork in, 268; choristers' school (illus.), 269.
- Sandbach Church, 99.
- Sanderson, architect, Kirtlington designed by, 200.
- Sandwich, foreign settlement in, 26; gatehouse (illus.), 251; Delf Street, brickwork in, 263-264; step gable, 264.
- Sandys, Lord, 17.
- Savorgnano, Mario, 61.
- Scarsdale, Lord, 196.
- Scamozzi, works of, 164.
- Scawen, Thomas, 173.
- Scenery for masques, 74-75.
- Scott the Parliamentarian and Lambeth Hall, 240.
- Scudamore, John, Viscount, Abbey Dore Church restored, 43.
- Seaton Delaval, 152.
- Serlby House, 196, 198.
- Serlio, Sebastian, works of, 164.
- Shaftesbury House, 76, 84-85.
- Shardeloe, 209.
- Shaw, Huntingdon, 291.
- Shaw House, entrance garden door, 32; (illus.), 295; H-shaped plan, 54; brickwork at, 264; Italian work at, 294.
- Shawfield, house at, by Campbell, 168.
- Shelburne House, 210.
- Sheldonian Theatre, 110-111.
- Sherborne Abbey, 292.
- Shers, John, purchaser of statues for Burghley, 24-25.

- Shrewsbury, half-timber houses in, 241; gatehouse, 241 (note); rain-water head at, 285; (illus.), 286.
- Shrewsbury, Earl of, letter to Duke of Buckingham, 229-230.
- Shrubland Hall, 198.
- Shurburne, Bishop, monument to, 14.
- Sidney-Sussex College, Simons and, 41.
- Simons, Ralph, life and work of, 41-42.
- Singleton, 55, 241 (note).
- Sion House, re-modelling of, 209, 212.
- Sirrigatti's "Practice of Perspective," translated by Ware, 186.
- Sissinghurst, house at (illus.), 243.
- Small Hythe, 263.
- Smarden, Kent, 241 (note); a spur at (illus.), 240.
- Smirke, Gunnersbury rebuilt by, 96.
- Smithells, 241 (note).
- Smithson, Huntingdon, work of, 39-41.
- Smithson, Robert, work of, 37, 39, 40-41.
- Snoring Rectory, *see* Great Snoring.
- Soane Museum, collection of drawings and plans at, 33, 51, 53, 54, 57, 59, 60, 61, 62, 64, 84; elevation of Greenwich Hospital in (illus.), 137; MS. by Gibbs in, 179.
- Society of Arts, house of, 210.
- Somerset House, 14, 24; design for additions, 84; chapel, 115; Chambers and, 204-206, 207.
- Somerset, Potocor, 24.
- South Kensington Museum, example of panel decoration in, 284.
- South Wingfield Manor House, 50.
- South Wraxhall, chimney-pieces, 28; ceiling at, 274.
- Southampton Street, panel decoration on houses, 284.
- Southwark, inns in, 56.
- Sparrow's House at Ipswich, 242-244; (illus.), 245; plaster work at, 274.
- Speke Hall, 241 (note).
- Spencer, Lord, house of, 189.
- Stafford, Sir H., Kirby and, 34.
- Stage scenery, by Inigo Jones, 74-75; by Vanbrugh, 150.
- Staircases, 56, 60, 66-70, 218, 228-233, 246; Ford Abbey, 88; Ashburnham House, 89-90; (illus.), 217; Amesbury, 222; Eltham House, 222; Buckingham House, 230; Hopetown House, 230-232.
- Standlynch, 191.
- Stanley Palace, 241 (note).
- Stanway Gatehouse, 52.
- Stapleton Park, 198.
- Star Inn, Yarmouth, ceilings, 273 (illus.), 275.
- Steelyard, the, 25, 294.
- Steeples, Wren's, 120-122; Gibbs on, 482, 483.
- Stevens, Richard, 30.
- Stibington Manor House, 96.
- Stockeld, Yorkshire, 196.
- Stockton, stonework at, 250; ceiling of drawing-room, 273 (illus.), 271.
- Stoke Park, 89, 223.
- Stone, Portland and Bath, use of, 248.
- Stone Buildings, Lincoln's Inn, 200.
- Stone, Nicholas, work on Sutton monument, 30; gateways by, 82.
- Stourhead, Wilts, 170.
- Stowe, ceilings at, 176; temples in gardens, 177, 185.
- Strand, Nos. 413 and 415 in, 244.
- Stratford Place, the Adams and, 210.
- Stratton Park, 200, 207.
- Strongs, the, chief masons of St. Paul's, 129, 256.
- Stuart, work at Greenwich, 138, 202.
- Stuart and Revett's "Athenian Antiquities," 202, 213.
- Stucco and plaster, introduction and use of, 268, 272-282.
- Sudbury, Flemish settlers in, 260.
- Suffolk, brickwork in, 260.
- Suffolk, Lady, house at Twickenham, 200.
- Sunningwell Church, 99.

- Sussex, half-timber buildings in, 237, 241.
- Sussex, Radcliffe, Earl of, monument to, 30.
- Sutton Place, terra-cotta work at, 6, 17; quadriangular plan, 50; builder of, 203.
- Sutton's monument in old Charterhouse chapel, 30.
- Swallowfield, 147.
- Switzer, Stephen, on skill of English masons, 164.
- Sydenham, 40; staircase at, 66, 68.
- Tabley, Cheshire, 201.
- Talman, William, life and work of, 147-149; jealousy of Wren, 132, 143; succeeded by Vanbrugh, 150; work at Chatsworth, 226.
- Tanfelde, Sir Lawrence, tomb of, 30.
- Tanfield Hall, 203.
- Taylor, Sir Robert, life and work of, 200-201.
- Temple, the, Fleet Street, rebuilding of, by Wren, 129.
- Temple Bar, 129.
- Tenterden, doorway (illus.), 23.
- Terra-cotta, use of, 4-6, 263; at Hampton Court, 4-5; bust at St. Donat's Castle, 5; roundel (illus.), 5; tomb in Rolls Chapel, 5; East Barsham Manor House, and Great Snoring Rectory, 262.
- Thanet, Isle of, foreign settlements in, 25-26.
- Theobalds, ceiling of hall, 63; lead cisterns at, 284.
- Thoresby House, 147, 201, 232.
- Thorndon Hall, 196, 198.
- Thornhill, Sir James, paintings at St. Paul's, 129; paintings at Greenwich, 168.
- Thornton Abbey, brickwork at, 260.
- Thornton College, second storey (illus.), 60.
- Thorpe, John, life and work of, 33-39.
- Thorpe Hall, 94; the stables (illus.), 95; ceiling of dining-room, 276.
- Thynne, Sir John, 14.
- Tijou, Jean, life and work of, 289-292; ironwork screen at St. Paul's by, 129; Hampton Court work, 129, 132.
- Timber and half-timber buildings, 237, 241-245.
- Tixall, gatehouse at, 52.
- Top-lighting of staircases, 230-233.
- Torrignano (Peter Torrysany), life and work of, 6-9, 18; terra-cotta tomb by, 5, 6.
- Toto, Anthony, *see* Nunziata, Toto del.
- Towers of Wren's churches, 120-122.
- Trades connected with architecture, 236-292.
- Treasury Buildings, 177.
- Tresham, Sir Thomas, buildings of, 32, 35-36; lodge at Ruston, 36, 59.
- Trevigi, Gerome da, 11.
- Triangular lodge at Rushton, 36, 59.
- Trinity Almshouses, 138, 267.
- Trinity College, Cambridge, Simons and, 41; library, 130; Essex's work at, 163; Bishop's Hostel, 267.
- Trinity College, Dublin, Chambers's work at, 203.
- Trinity College, Oxford, 111.
- Trinity Hall, Cambridge, Burrough's work at, 162; lead figures in gardens, 286-287.
- Troisriex, Dominique, 25.
- Turner, John, 146.
- Twickenham, house at by James, 167; Gibbs's work at, 185; Lady Suffolk's house at, 200.
- Tytenhanger, 267-268.
- Umberslade, 166.
- Urns, lead, 285-287 (illus.), 287; stone urn (illus.), 304.
- Vanbrugh, John, life and work of, 149-154; work at Greenwich, 136; Hawksmoor and, 143, 155, 159; Archer, pupil of, 165; Ripley

- succeeds, 173; Horse Guards finished by, 177; method of house planning, 223-224; Sir J. Reynolds on, 224; Duncombe Park designs, 226; work at Grimsthorpe, 226; style of architecture, 302.
- Vardy, John, life and work of, 186, 187, 189-190; "Some designs by Mr. Inigo Jones and Mr. W. Kent," published by, 177; death of, 194.
- Venice, relations with England, 19-20.
- Verona, Jacopo da, 9.
- Vignola, works of, 164.
- Vitruvius, works of, Italian editions of, 27; Dean Aldrich's notes on, 160; study of, 164.
- "Vitruvius Britannicus," 76, 90, 143, 154, 168, 169, 189, 212, 224, 232.
- Vosbergh, Casper, 25.
- Vrese, *see* Frisius.
- Vulp, Vincent, 11.
- Vyne, The, Italian work at, 17, 18; doorway (illus.), 93; Webb's work at, 94; builder of, 263; lead cistern at, 284 (illus.), 283.
- Wadham College, Holt and, 41; windows of, 104.
- Wakefield, William, work of, 154, 226.
- Wakehurst, 253.
- Wallingford, Town Hall, 258; brick house in, 269-270.
- Walpole, Horace, on Wolterton House, 173; on Lord Burlington, 174; on Kent, 176.
- Walpole, Sir Robert, Ripley patronized by, 173; Houghton designed for, 170.
- Walton Bridge, 197.
- Wanstead, Campbell's designs for, 170, 188; ceilings at, 176.
- Wanswell Court, 60.
- Warborough Church, 106.
- Warde, Roger, Burghley House and, 24.
- Wardour House, 196, 198, 224; section of (illus.), 190.
- Ware, Isaac, life and work of, 186-187, 192; death of, 194; plan for house in Bloomsbury Square, 232-233; ceilings by, 280.
- Warwick, County Hall at, 200.
- Water Eaton Church, 100.
- Webb, John, life and work of, 91-96; "Vindication of Stonehenge restored," by, 71, 91; designs in "Vitruvius Britannicus," 76; Whitehall drawings, 78; work at Wilton, 86; drawings of Kirby, 88; houses by, 89; work at Ashburnham, 89-90; Inigo Jones and, 91; Wren and, 96, 109; work at Greenwich, 134; designs by, 190; house in Great Queen Street, 267; plaster work by, 276.
- Welland Church, 106.
- Wentworth House, Flitcroft's engraving, 188-189; Carr's work at, 201; gallery of, 234.
- Weobley, Market Hall and porch, 42-43.
- West, Bishop, Chapel at Ely, 16, 273.
- West Drayton, plaster work at, 274.
- West Woodhay House, Inigo Jones and, 84; brickwork at, 266.
- Westley, John, 42, 49.
- Westminster, Chapter House, Ripley and, 173; dormitory at, 174, 175, 185; Law Courts, 173, 189, 190.
- Westminster Abbey, Henry VII.'s tomb and chapel, 6-8, 288; monuments in, 30; Hawksmoor appointed surveyor, 159.
- Weston, Sir Richard, 263.
- Westwood, gatehouse, 52.
- Whitecross Street, old staircase (illus.), 68.
- Whitehall, gatehouses at, 14; drawing for door (illus.), 73; Inigo Jones's design for, 76-80; ground plan (illus.), 77; banqueting hall (illus.), 79; Inigo Jones's work at, contrasted with Somerset House,

- 205-206; Lord Herbert's house in, 172; Lord Gower's house in, 204.
 White's Club House, 210.
 Wigge, Gilbert, 42.
 Wilbury, 168.
 Wilderness Park, 207.
 Wilkins, 88, 184, 303.
 Willesley, 265.
 William III., alterations at Hampton Court, 132, 147.
 Wilton, gateway or garden house, 14; gardens designed, 30; ceiling at (illus.), 85; designs for and building of, 86; Webb and, 91; double cube room, 150, 222; chimney, (illus.), 87; bridge at, 200; entrance archway, 203.
 Wimbledon House, 200.
 Wimbledon Old House, 63; plan of (illus.), 62.
 Winchester, Wren's work at, 130; 142; Wolvesey episcopal palace at, 130, chapel (illus.), 131; Royal palace, 130; Hawksmoor employed at, 154.
 Winchester Cathedral, chest on choir screen, (illus.) 15; chantry and tomb of Stephen Gardiner, 16; choir screen, 84; brickwork in Close, 268.
 Winde, Captain, *see* Wynne.
 Windsor Castle, brickwork at, 264; lead fountain at, 284.
 Witham 210.
 Woburn Abbey, 188, 189; quadrangular court, 226.
 Wolfe and Gandon, on architecture in eighteenth century, 167.
 Wollaton, gables at, 27; Thorpe, 33; Smithson and, 37, 39, 41; plan of (illus.), 64; architecture of, 253.
 Wolsey, Hampton Court and, 4, 7; tomb of, 8, 9-10.
 Wolterton House, 173.
 Wolverhampton, St. Peter's Church, 99.
 Wolvesey episcopal palace, 130; chapel of (illus.), 131.
 Wood, John and Son, life and work of, 186, 190-191.
 Woodroffe, work at Cambridge, 246.
 Worcester College Library, designs, drawings, and plans, in, 76, 84, 88, 90; Inigo Jones's designs in, 160.
 Worksoy, Manor House, 196.
 Worstead, Flemish settlers in, 260.
 Wotton House, brick and stonework at, 267-268.
 Wren, Sir Christopher, life and work of, 109-142; Hampton Court Gallery destroyed by, 61; appointed surveyor of works, 96; plan for rebuilding London (illus.), 113; plan and elevation (illus.), 141; influence on architecture, 143, 297; Talman and, 149; succeeded by Vanbrugh at Greenwich, 152; Hawksmoor and, 154-155, 159; Campbell and, 173; Westminster dormitory design, 175; Gibbs and, 179-185, 186; design for King's College, Cambridge, 183; Hampton Court plan, 226; Marlborough House plan, 228; plan and elevation, 229; use of brickwork by, 267-268, 272; Portland stone and gauged brick used by, 268; plaster work by, 276-279; Tijou employed by, 289-291.
 Wren, Matthew, Peterhouse, Cambridge, and, 102.
 Wrest Park, Pavilion in, 165.
 Wright, University Library at Cambridge by, 183.
 Wright, S., 200.
 Wrotham Park, 187.
 Württemberg, Frederick, Duke of, lead fountain at Windsor seen by, 284.
 Wyatt, James, work at Wilton, 86.
 Wye College, staircase at, 69.
 Wyndham, Thomas, house at Hammersmith, 200.
 Wynne, Sir Watkin, house in St. James's Square, 210, 212.
 Wynne, Capt. William, life and work of, 144-146; work at Hampstead Marshall, 97-98; work at

- Buckingham Palace and Old Cliefden House, 109, 223; Newcastle House design, 228.
- Wyvenhoe, plaster work at, 274.
- Yarmouth, Great, St. George's Chapel at, 257 (illus.), 258; hospital for fishermen, 258; Star Inn, ceilings, and, 273-274 (illus.), 275.
- York, Duke of, Palace in Pall Mall, design for, 232.
- York, Assembly Rooms, 174, 175; County Court House at, 201.
- York House, watergate at, 82.
- Yorkshire, buildings in, 250, 252.
- Young, John, tomb of, 5, 6.
- Zucchi, stucco work at Kenwood coloured by, 282.

